

6367254 MOTOROLA SC (XSTRS/R F)
MOTOROLA
SEMICONDUCTOR
 TECHNICAL DATA

96D 80416 D
2N6049 T-33-21

MEDIUM-POWER PNP SILICON TRANSISTOR

... designed for general-purpose switching and amplifier applications

- Excellent Safe Operating Area
- DC Current Gain Specified to 4.0 Amperes
- Complement to NPN Type 2N3054A

4 AMPERE
POWER TRANSISTOR
PNP SILICON
55 VOLTS
75 WATTS

***MAXIMUM RATINGS**

Rating	Symbol	Value	Unit
Collector-Emitter Voltage	V _{CEO}	55	Vdc
Collector-Emitter Voltage (R _{BE} = 100 Ω)	V _{CER}	60	Vdc
Collector-Base Voltage	V _{CB}	90	Vdc
Emitter-Base Voltage	V _{EB}	7.0	Vdc
Collector Current - Continuous	I _C	4.0	Adc
Peak		10	
Base Current	I _B	2.0	Adc
Total Device Dissipation @ T _C = 25°C	P _D	75	Watts
Derate above 25°C		0.43	W/°C
Operating and Storage Junction, Temperature Range	T _J , T _{stg}	-65 to +200	°C

*Indicates JEDEC Registered Data

THERMAL CHARACTERISTICS

Characteristic	Symbol	Max	Unit
Thermal Resistance, Junction to Case	θ _{JC}	2.33	°C/W

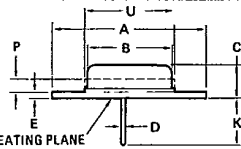
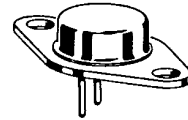

STYLE 1:
 PIN 1: BASE
 2: EMITTER
 CASE: COLLECTOR

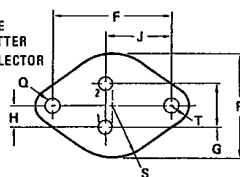

DIM	MILLIMETERS		INCHES	
	MIN	MAX	MIN	MAX
B	11.94	12.70	0.470	0.500
C	6.35	8.64	0.250	0.340
D	0.71	0.86	0.028	0.034
E	1.27	1.91	0.050	0.075
F	24.33	24.43	0.958	0.962
G	4.83	5.33	0.190	0.210
H	2.41	2.67	0.095	0.105
J	14.48	14.99	0.570	0.590
K	9.14	-	0.360	-
P	-	1.27	-	0.050
Q	3.61	3.86	0.142	0.152
S	-	8.89	-	0.350
T	-	3.68	-	0.145
U	-	116.75	-	0.620

All JEDEC Dimensions and Notes Apply.

CASE 80-02
TO-213AA

FIGURE 1 - POWER-TEMPERATURE DERATING

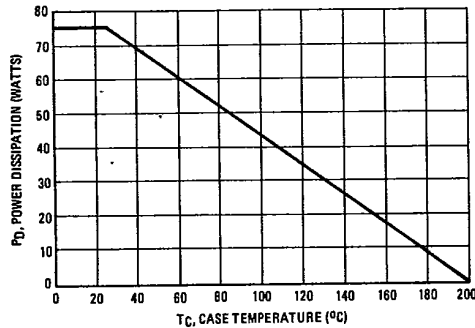

6367254 MOTOROLA SC (XSTRS/R F)

96D 80417 D

T-33-21

2N6049

*ELECTRICAL CHARACTERISTICS (T_C = 25°C unless otherwise noted)

Characteristic	Symbol	Min	Max	Unit
OFF CHARACTERISTICS				
Collector-Emitter Sustaining Voltage (1) (I _C = 100 mA _{dc} , I _B = 0)	V _{CEO(sus)}	55	—	V _{dc}
Collector-Emitter Sustaining Voltage (1) (I _C = 100 mA _{dc} , R _{BE} = 100 Ω)	V _{CER(sus)}	60	—	V _{dc}
Collector Cutoff Current (V _{CE} = 30 V _{dc} , I _B = 0)	I _{CEO}	—	500	μA _{dc}
Collector Cutoff Current (V _{CE} = 90 V _{dc} , V _{BE(off)} = 1.5 V _{dc}) (V _{CE} = 90 V _{dc} , V _{BE(off)} = 1.5 V _{dc} , T _C = 150°C)	I _{CEX}	—	1.0 6.0	mA _{dc}
Emitter Cutoff Current (V _{BE} = 7.0 V _{dc} , I _C = 0)	I _{EBO}	—	1.0	mA _{dc}
ON CHARACTERISTICS (1)				
DC Current Gain (I _C = 500 mA _{dc} , V _{CE} = 4.0 V _{dc}) (I _C = 3.0 A _{dc} , V _{CE} = 4.0 V _{dc})	h _{FE}	25 6.0	100	—
Collector-Emitter Saturation Voltage (I _C = 500 mA _{dc} , I _B = 50 mA _{dc}) (I _C = 4.0 A _{dc} , I _B = 800 mA _{dc})	V _{CE(sat)}	—	0.5 2.0	V _{dc}
Base-Emitter On Voltage (I _C = 500 mA _{dc} , V _{CE} = 4.0 V _{dc})	V _{BE(on)}	—	1.0	V _{dc}
DYNAMIC CHARACTERISTICS				
Current Gain — Bandwidth Product (I _C = 200 mA _{dc} , V _{CE} = 10 V _{dc})	f _T	3.0	—	MHz
Output Capacitance (V _{CB} = 10 V _{dc} , I _E = 0, f = 0.1 MHz)	C _{ob}	—	200	pF
Small-Signal Current Gain (I _C = 100 mA _{dc} , V _{CE} = 4.0 V _{dc} , f = 1.0 kHz)	h _{fe}	25	180	—

*Indicates JEDEC Registered Data
(1) Pulse test: Pulse Width ≤ 300 μs, Duty Cycle ≤ 2.0%



FIGURE 2 — SWITCHING TIME EQUIVALENT TEST CIRCUIT

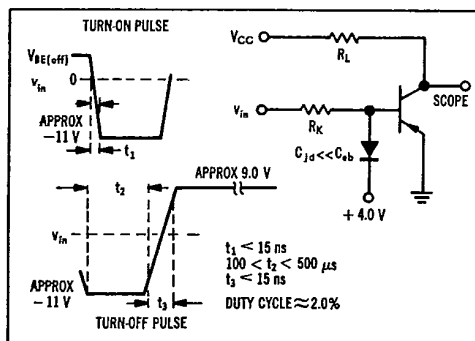
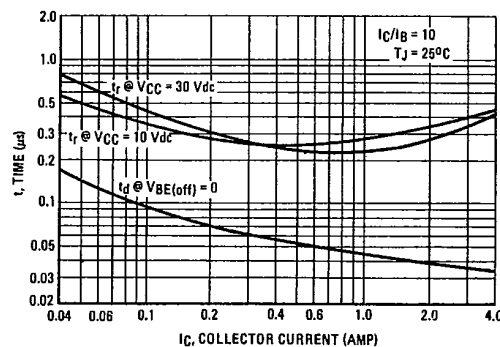

FIGURE 3 — TURN-ON TIME



6367254 MOTOROLA SC (XSTRS/R F)

96D 80418 D

2N6049

T-33-21

FIGURE 4 - THERMAL RESPONSE

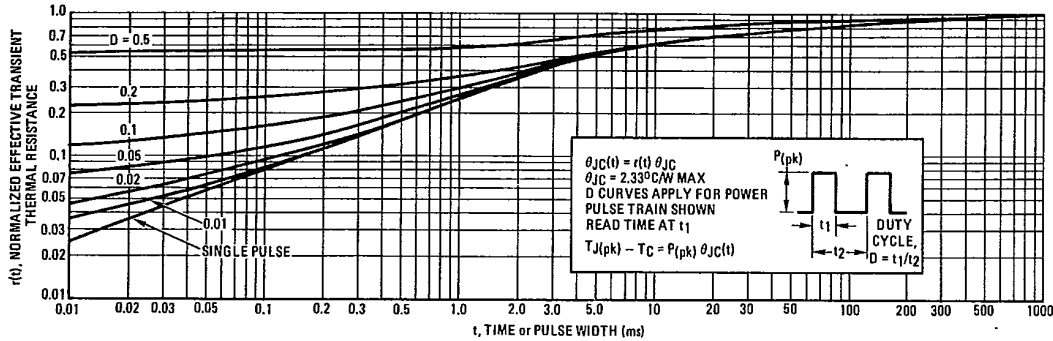
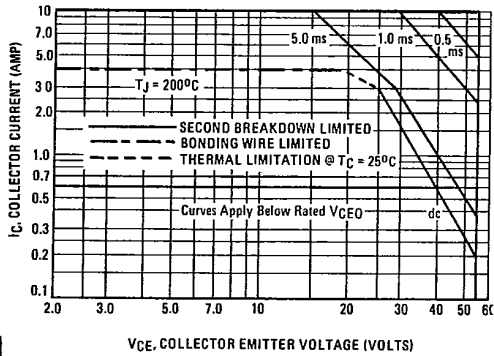

FIGURE 5 - ACTIVE-REGION SAFE OPERATING AREA



There are two limitations on the power handling ability of a transistor: average junction temperature and second breakdown. Safe operating area curves indicate $I_C - V_{CE}$ limits of the transistor that must be observed for reliable operation; i.e., the transistor must not be subjected to greater dissipation than the curves indicate.

The data of Figure 5 is based on $T_{J(pk)} = 200^\circ\text{C}$; T_C is variable depending on conditions. Second breakdown pulse limits are valid for duty cycles to 10% provided $T_{J(pk)} < 200^\circ\text{C}$. $T_{J(pk)}$ may be calculated from the data in Figure 4. At high case temperatures, thermal limitations will reduce the power that can be handled to values less than the limitations imposed by second breakdown.



FIGURE 6 - TURN-OFF TIME

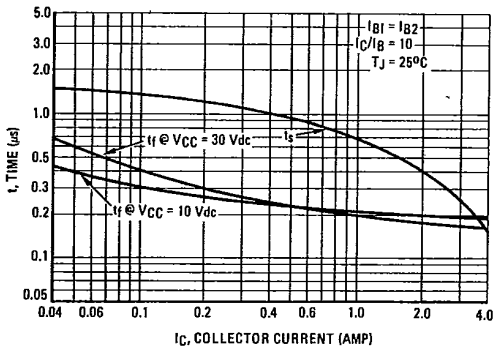
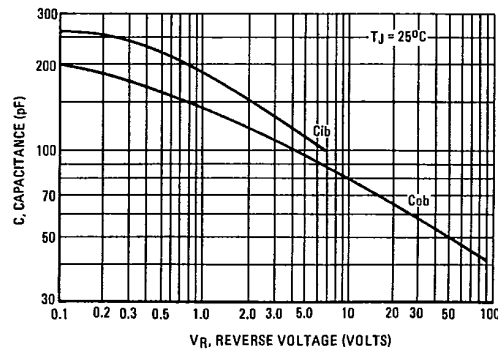

FIGURE 7 - CAPACITANCE



6367254 MOTOROLA SC (XSTRS/R F)

96D 80440

D
T-33-11

**MOTOROLA
SEMICONDUCTOR
TECHNICAL DATA**

**2N6233
2N6235**

HIGH VOLTAGE NPN SILICON TRANSISTORS

... useful for high-voltage medium power applications such as switching regulators.

- High Collector-Emitter Sustaining Voltage –
 $V_{CE(sus)} = 225 \text{ Vdc} - 2N6233$
 $325 \text{ Vdc} - 2N6235$
- DC Current Gain – $h_{FE} = 25 \text{ to } 125 - I_C = 1.0 \text{ Adc}$
- Low Collector-Emitter Saturation Voltage
 $V_{CE(sat)} = 0.5 \text{ Vdc (Max) @ } I_C = 1.0 \text{ Adc}$
- High Frequency Response – $f_T = 20 \text{ MHz (Min)}$
- Fast Switching Times @ 1.0 Adc –
 $t_r = 0.5 \mu\text{s (Max)}$
 $t_s = 3.5 \mu\text{s (Max)}$
 $t_f = 0.5 \mu\text{s (Max)}$

5 AMPERE

**POWER TRANSISTORS
NPN SILICON**

**225,275,325 VOLTS
50 WATTS**

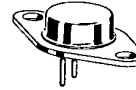

***MAXIMUM RATINGS**

Rating	Symbol	2N6233	2N6235	Unit
Collector-Emitter Voltage	V_{CEO}	225	325	Vdc
Collector-Base Voltage	V_{CB}	250	350	Vdc
Emitter-Base Voltage	V_{EB}	6.0		Vdc
Collector Current – Continuous	I_C	5.0		A dc
Peak		10		
Base Current	I_B	2.0		A dc
Total Device Dissipation @ $T_C = 25^\circ\text{C}$ Derate above 25°C	P_D	50	0.286	Watts W/C
Operating and Storage Junction Temperature Range	T_J, T_{stg}	-65 to +200		$^\circ\text{C}$

THERMAL CHARACTERISTICS

Characteristic	Symbol	Max	Unit
Thermal Resistance, Junction to Case	θ_{JC}	3.5	$^\circ\text{C/W}$

*Indicates JEDEC Registered Data.



FIGURE 1 – POWER TEMPERATURE DERATING

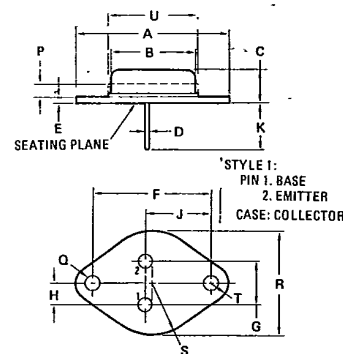
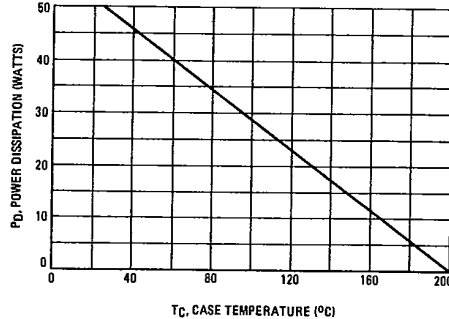

DIM	MILLIMETERS		INCHES	
	MIN	MAX	MIN	MAX
B	11.94	12.70	0.470	0.500
C	6.35	8.64	0.250	0.340
D	0.71	0.86	0.028	0.034
E	1.27	1.91	0.050	0.075
F	24.33	24.43	0.958	0.962
G	4.83	5.33	0.180	0.210
H	2.41	2.67	0.095	0.105
J	14.48	14.99	0.570	0.590
K	9.14	—	0.360	—
P	—	1.27	—	0.050
Q	3.61	3.86	0.142	0.152
S	—	8.89	—	0.350
T	—	3.68	—	0.145
U	—	15.75	—	0.620

All JEDEC Dimensions and Notes Apply.

**CASE 80-02
TO-213AA**

6367254 MOTOROLA SC (XSTRS/R F)

96D 80441 D

2N6233, 2N6235

T-33-11

***ELECTRICAL CHARACTERISTICS (T_C = 25°C unless otherwise noted)**

Characteristic	Symbol	Min	Max	Unit	
OFF CHARACTERISTICS					
Collector-Emitter Sustaining Voltage (1) (I _C = 20 mA, I _B = 0)	2N6233 2N6235	V _{CEO(sus)}	225 325	—	Vdc
Collector Cutoff Current (V _{CE} = 225 V, I _B = 0) (V _{CE} = 325 V, I _B = 0)	2N6233 2N6235	I _{CEO}	— —	1.0 1.0	mA
Collector Cutoff Current (V _{CE} = 250 Vdc, V _{EB(off)} = 1.5 Vdc, T _C = 150°C) (V _{CE} = 350 Vdc, V _{EB(off)} = 1.5 Vdc, T _C = 150°C)	2N6233 2N6235	I _{CEX}	— —	1.0 1.0	mA
Collector Cutoff Current (V _{CB} = 250 Vdc, I _E = 0) (V _{CB} = 350 Vdc, I _E = 0)	2N6233 2N6235	I _{CBO}	— —	0.1 0.1	mA
Emitter Cutoff Current (V _{BE} = 6.0 Vdc, I _C = 0)		I _{EBO}	—	0.1	mA
ON CHARACTERISTICS (1)					
DC Current Gain (I _C = 0.1 Adc, V _{CE} = 5.0 Vdc) (I _C = 1.0 Adc, V _{CE} = 5.0 Vdc) (I _C = 3.0 Adc, V _{CE} = 5.0 Vdc)		h _{FE}	25 25 10	— 125 —	—
Collector-Emitter Saturation Voltage (I _C = 1.0 Adc, I _B = 0.1 Adc) (I _C = 5.0 Adc, I _B = 1.0 Adc)		V _{CE(sat)}	— —	0.5 2.5	Vdc
Base-Emitter Saturation Voltage (I _C = 1.0 Adc, I _B = 0.1 Adc) (I _C = 5.0 Adc, I _B = 1.0 Adc)		V _{BE(sat)}	— —	1.0 2.0	Vdc
Base-Emitter On Voltage (I _C = 1.0 Adc, V _{CE} = 5.0 Vdc)		V _{BE(on)}	—	1.0	Vdc
DYNAMIC CHARACTERISTICS					
Current-Gain Bandwidth Product (2) (I _C = 0.25 Adc, V _{CE} = 10 Vdc, f _{test} = 10 MHz)		f _T	20	—	MHz
Output Capacitance (V _{CB} = 10 Vdc, I _E = 0, f = 0.1 MHz)		C _{ob}	—	250	pF
SWITCHING CHARACTERISTICS					
Rise Time (V _{CC} = 200 Vdc, I _C = 1.0 Adc, I _B = 0.1 Adc)		t _r	—	0.5	μs
Storage Time (V _{CC} = 200 Vdc, I _C = 1.0 Adc, I _{B1} = I _{B2} = 0.1 Adc)		t _s	—	3.5	μs
Fall Time (V _{CC} = 200 Vdc, I _C = 1.0 Adc, I _{B1} = I _{B2} = 0.1 Adc)		t _f	—	0.5	μs

*Indicates JEDEC Registered Data.

(1) Pulse Test: Pulse Width ≤ 300 μs, Duty Cycle ≤ 2.0%.

(2) f_T = |h_{FE}| * f_{test}

FIGURE 2 - SWITCHING TIME TEST CIRCUIT

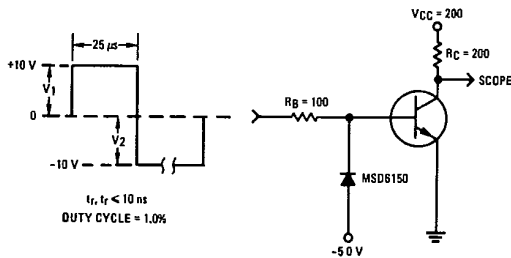

FOR INFORMATION ON FIGURES 3 AND 6
R_B AND R_C ARE VARIED TO OBTAIN
DESIRED CURRENT LEVELS; D₁ DIS-
CONNECTED AND V₂ REDUCED TO 5
VOLTS FOR t_d MEASUREMENT.

FIGURE 3 - TURN-ON TIME

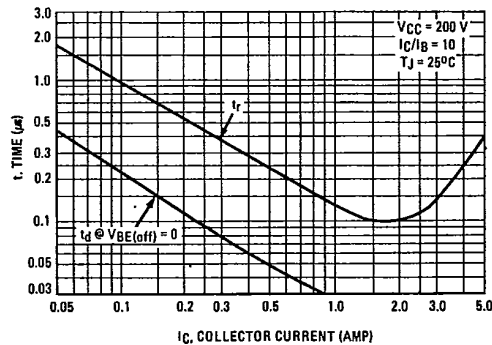

6367254 MOTOROLA SC (XSTRS/R F)
 2N6233, 2N6235

96D 80442 D

T-33-11

FIGURE 4 - THERMAL RESPONSE

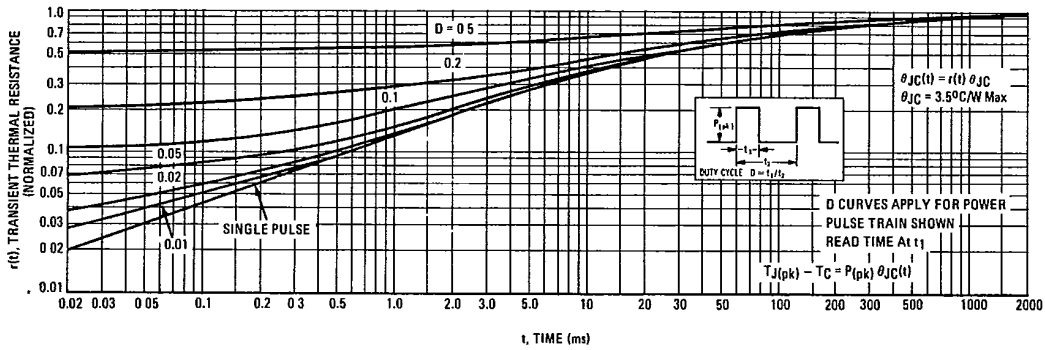
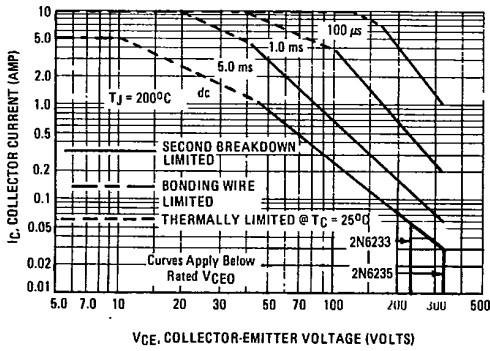

FIGURE 5 - ACTIVE-REGION SAFE OPERATING AREA



There are two limitations on the power handling ability of a transistor: average junction temperature and second breakdown. Safe operating area curves indicate $I_C - V_{CE}$ limits of the transistor that must be observed for reliable operation; i.e., the transistor must not be subjected to greater dissipation than the curves indicate.

The data of Figure 5 is based on $T_{J(pk)} = 200^\circ\text{C}$; T_C is variable depending on conditions. Second breakdown pulse limits are valid for duty cycles to 10% provided $T_{J(pk)} \leq 200^\circ\text{C}$. $T_{J(pk)}$ may be calculated from the data in Figure 4. At high case temperatures, thermal limitations will reduce the power that can be handled to values less than the limitations imposed by second breakdown.



FIGURE 6 - TURN-OFF TIME

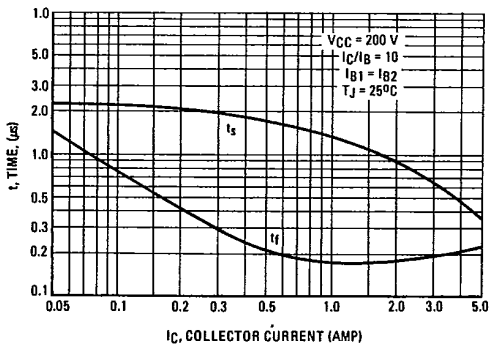
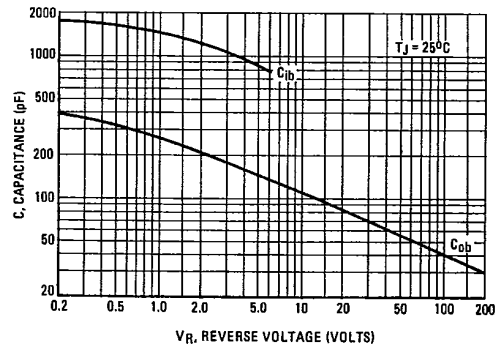

FIGURE 7 - CAPACITANCES





LittleDiode supplies new, hard to find or obsolete electronic components and semiconductors all over the world.

With over two million different components listed you are sure to find the part you need.

Feel free to visit us today at our online store:

LittleDiode.com

Looking forward to providing you with the best possible service.