

SERIAL BUS CONTROLLED AUDIO PROCESSOR

PRELIMINARY DATA

- INPUT MULTIPLEXER:
 - 4 STEREO INPUTS
 - ONE DIFFERENTIAL STEREO INPUT FOR REMOTE SOURCES
- SELECTABLE INPUT GAIN FOR OPTIMAL ADAPTION TO DIFFERENT SOURCES
- INPUT AND OUTPUT FOR EXTERNAL EQUALIZER OR NOISE REDUCTION SYSTEM
- VOLUME CONTROL IN 1.25dB STEPS
- LOUDNESS FUNCTION
- TREBLE AND BASS CONTROL
- FOUR SPEAKER ATTENUATORS:
 - 4 INDEPENDENT SPEAKERS CONTROL IN 1.25dB STEPS FOR BALANCE AND FADER FACILITIES
 - INDEPENDENT MUTE FUNCTION
- ALL FUNCTIONS PROGRAMMABLE VIA SERIAL BUS
- SELECTABLE CHIP ADDRESS DEDICATED PIN

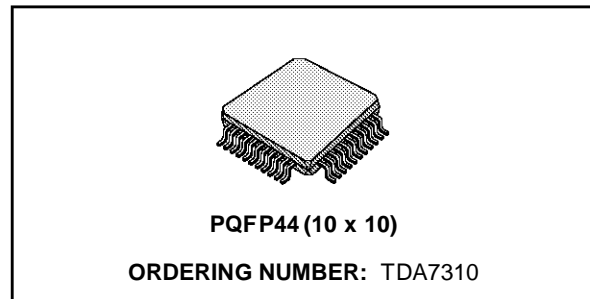

DESCRIPTION

The TDA7310 is a volume, tone (bass and treble) and fader (front/rear) processor for high quality audio applications in car radio and Hi-Fi systems.

Loudness and selectable input gain are provided. The control of all functions is accomplished by serial bus microprocessor interface.

The AC signal setting is obtained by resistor networks and switches combined with operational amplifiers.

Thanks to the used BIPOLAR/CMOS Technology, Low Distortion, Low Noise and DC stepping are obtained.

PIN CONNECTION (Top view)

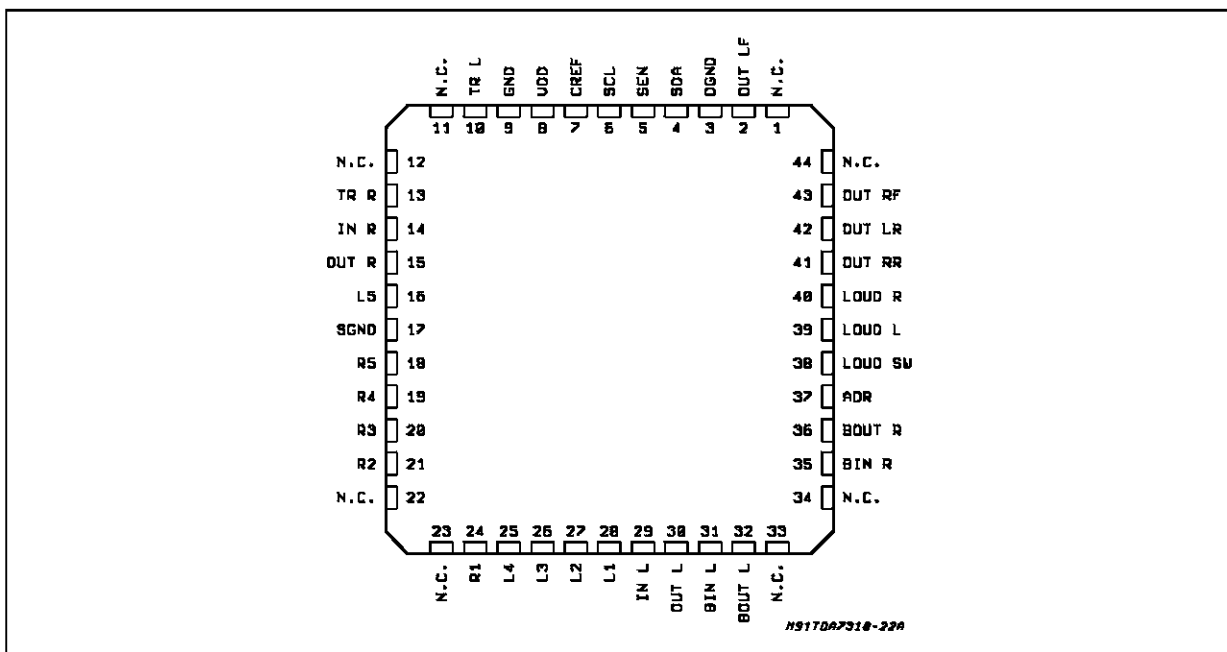

TDA7310

TEST CIRCUIT

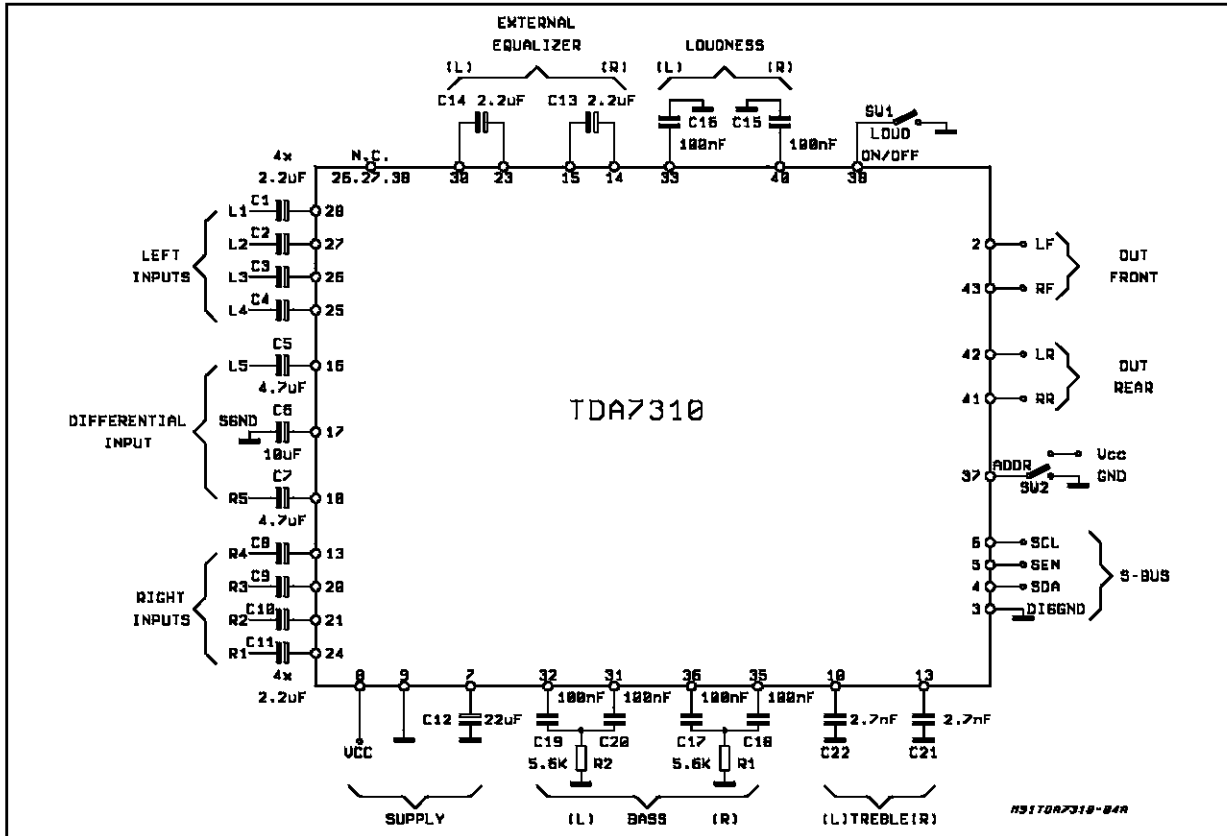

THERMAL DATA

Symbol	Description	Value	Unit
$R_{th \text{ j-pins}}$	Thermal Resistance Junction-pins	max	85 °C/W

ABSOLUTE MAXIMUM RATINGS

Symbol	Parameter	Value	Unit
V_S	Operating Supply Voltage	10.2	V
T_{amb}	Ambient Temperature	-40 to 85	°C
T_{stg}	Storage Temperature Range	-55 to +150	°C

QUICK REFERENCE DATA

Symbol	Parameter	Min.	Typ.	Max.	Unit
V_S	Supply Voltage	6	9	10	V
V_{CL}	Max. input signal handling	2			V _{rms}
THD	Total Harmonic Distortion $V = 1V_{rms}$ $f = 1KHz$		0.01		%
S/N	Signal to Noise Ratio		106		dB
S_c	Channel Separation $f = 1KHz$		103		dB
	Volume Control 1.25dB step	-78.75		0	dB
	Bass and Treble Control 2dB step	-14		+14	dB
	Fader and Balance Control 1.25dB step	-38.75		0	dB
	Input Gain 6.25dB step	0		18.75	dB
	Mute Attenuation		100		dB

BLOCK DIAGRAM

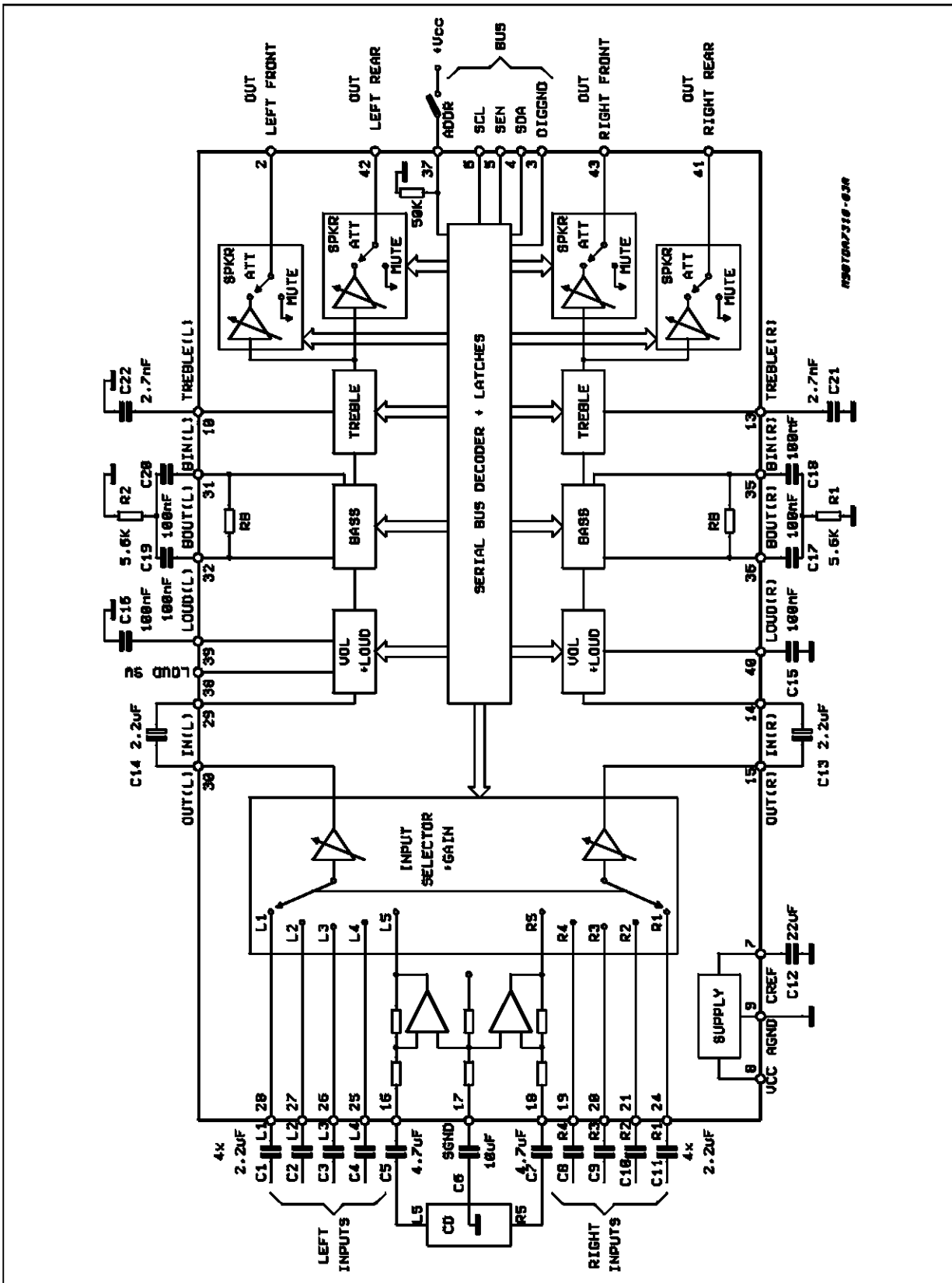

TDA7310

ELECTRICAL CHARACTERISTICS ($T_{amb} = 25^{\circ}\text{C}$, $V_S = 9\text{V}$, $R_L = 10\text{K}\Omega$, $R_G = 600\Omega$, $G_V=0\text{dB}$, $f = 1\text{KHz}$ unless otherwise specified) (refer to the test circuit)

Symbol	Parameter	Test Condition	Min.	Typ.	Max.	Unit
--------	-----------	----------------	------	------	------	------

SUPPLY

V_S	Supply Voltage		6	9	10	V
I_S	Supply Current		4	8	11	mA
SVR	Ripple Rejection		60	85		dB

INPUT SELECTORS

R_{II}	Input Resistance	Input 1, 2, 3, 4		50		$\text{K}\Omega$
		Differential Input		10		$\text{K}\Omega$
V_{CL}	Clipping Level		2	2.5		V _{rms}
CMRR	Common Mode Rejection Differential Input			65		dB
INS	Input Separation (2)		80	100		dB
R_L	Output Load resistance		2			$\text{K}\Omega$
G_{INmin}	Min. Input Gain		-1	0	1	dB
G_{INmax}	Max. Input Gain			18.75		dB
G_{STEP}	Step Resolution			6.25		dB
e_{IN}	Input Noise	$G = 18.75\text{dB}$		2		μV
V_{DC}	DC Steps	adjacent gain steps		4		mV
		$G = 18.75$ to Mute		4		mV

VOLUME CONTROL

R_{IN}	Input Resistance			33		$\text{k}\Omega$
C_{RANGE}	Control Range			75		dB
A_{VMIN}	Min. Attenuation		-1	0	1	dB
A_{VMAX}	Max. Attenuation			75		dB
A_{STEP}	Step Resolution			1.25		dB
E_A	Attenuation Set Error	$A_V = 0$ to -20dB $A_V = -20$ to -60dB	-1.25 -3	0	1.25 2	dB dB
E_T	Tracking Error				2	dB
V_{DC}	DC Steps	adjacent attenuation steps		0.1		mV
		From 0dB to A_{Vmax}		0.5		mV

SPEAKER ATTENUATORS

	Control Range			37.5		dB
	Step Resolution			1.25		dB
	Attenuation set error				1.5	dB
	Output Mute Attenuation		80	100		dB
	DC Steps	adjacent att. steps from 0 to mute		0		mV
				1		mV

BASS CONTROL (1)

	Control Range			± 14		dB
	Step Resolution			2		dB
R_B	Internal Feedback Resistance			50		$\text{K}\Omega$
V_{DC}	DC Steps	adjacent control steps		0.1		mV

ELECTRICAL CHARACTERISTICS (continued)

Symbol	Parameter	Test Condition	Min.	Typ.	Max.	Unit
TREBLE CONTROL (1)						
	Control Range			±14		dB
	Step Resolution			2		dB
V _{DC}	DC Steps	adjacent control steps		0.1		mV

AUDIO OUTPUTS

	Clipping Level	d = 0.3%		2.5		V _{rms}
	Output Load Resistance		2			KΩ
	Output Load Capacitance				10	nF
	Output resistance			75	120	Ω
	DC Voltage Level		4.2	4.5	4.8	V

GENERAL

e _{NO}	Output Noise	BW = 20-20KHz, flat output muted all gains = 0dB		2.5 5	15	μV μV
S/N	Signal to Noise Ratio	all gains = 0dB; V _O = 1V _{rms}		106		dB
d	Distortion	V _{IN} = 1V _{rms}		0.01		%
Sc	Channel Separation left/right		80	103		dB
	Total Tracking error	A _V = 0 to -20dB -20 to -60 dB		0 0	1 2	dB dB

BUS INPUTS

V _{IL}	Input Low Voltage				1	V
V _{IH}	Input High Voltage		3			V
V _O	Output Voltage SDA Acknowledge	I _O = 1.6mA			0.4	V

LOUDNESS SWITCH

V _{IL}	Input Low Voltage				1	V
V _{IH}	Input High Voltage		3			V
I _{IN}	Input Current		-5		+5	μA
	DC Step	ON ← → OFF position		0.1		mV

Loudness OFF = pin38 Open; Loudness ON = pin 38 Closed to GND

ADDRESS PIN (Internal 50KΩ pull down resistor)

V _{IL}	Input Low Voltage				1	V
V _{IH}	Input High Voltage		V _{CC} -1V			V
I _{IN}	Input Current					μA

Notes:

- (1) Bass and Treble response see attached diagram (fig.17). The center frequency and quality of the resonance behaviour can be chosen by the external circuitry. A standard first order bass response can be realized by a standard feedback network
- (2) The selected input is grounded thru the 2.2μF capacitor.

TDA7310

APPLICATION SUGGESTION (see to Test circuit)

Component	Recc. Value	Purpose	Smaller than Recc. Value	Larger than
C1 to C4, C8 to C11	2.2 μ F	THD optimization at low frequencies	Worse THD at very low frequencies	
C5, C7 C6	4.7 μ F 10 μ F	CMRR optimization differential input	Worse CMRR for ratio not equal to 1/2	
C12	22 μ F	C _{REF} • SVR optimization < -66 dB	Better SVR at low frequencies	Worse SVR at low frequencies
C13, C14	2.2 μ F	Decoupling Input-Output if external equalizer is not used		
C15, C16	100nF	Loudness characteristic		
C17, C18 R1 C19, C20 R2	100nF 5.6k Ω 100nF 5.6k Ω	Bass Filter (standard T - type) cut freq. = 100Hz		
C21 C22	2.7nF	Treble Filter	Higher cut frequency	Lower cut frequency

Figure 1: Loudness versus Volume Attenuation

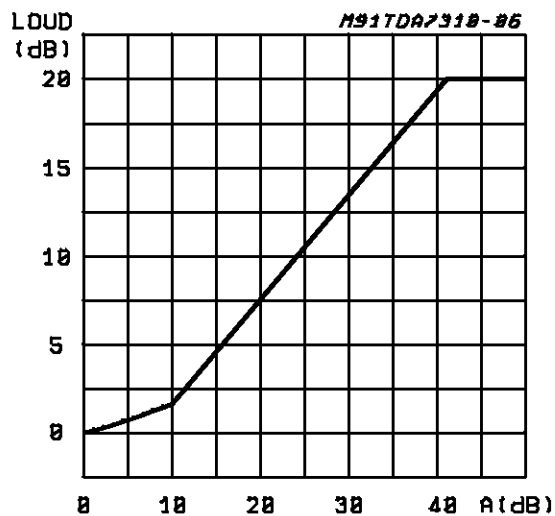

Figure 2: Loudness versus Frequency (C_{LOUD} = 100nF)

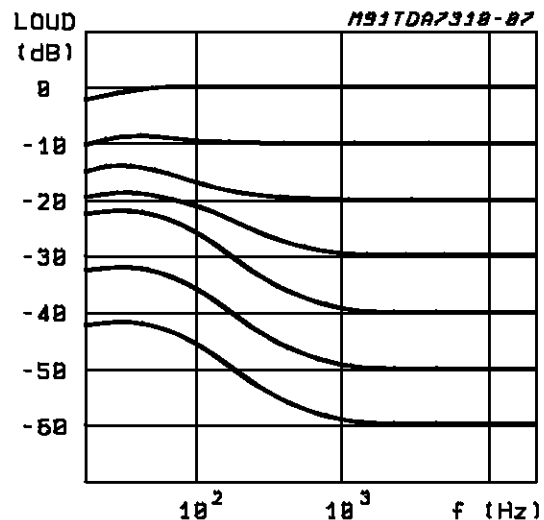
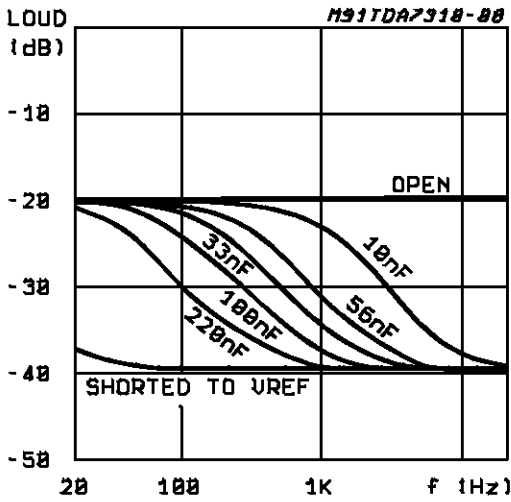

Figure 3: Loudness versus External Capacitors



LOUDNESS
 $V_s = 9V$
 Volume = -40dB
 All other control flat
 $C_{in} = 2.2\mu F$

Figure 4: Noise vs. Volume/Gain Settings

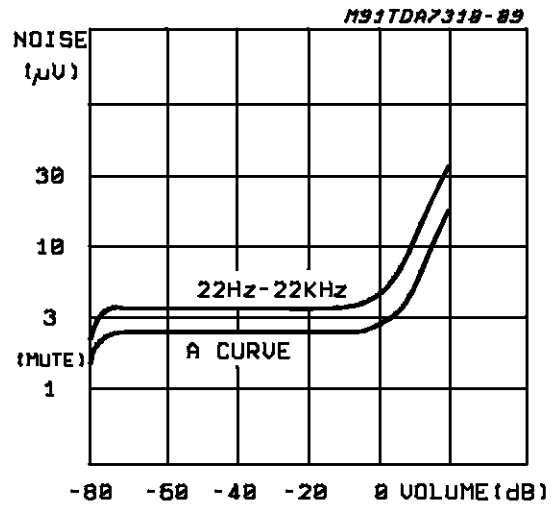

Figure 5: Signal to Noise Ratio vs. Volume Setting

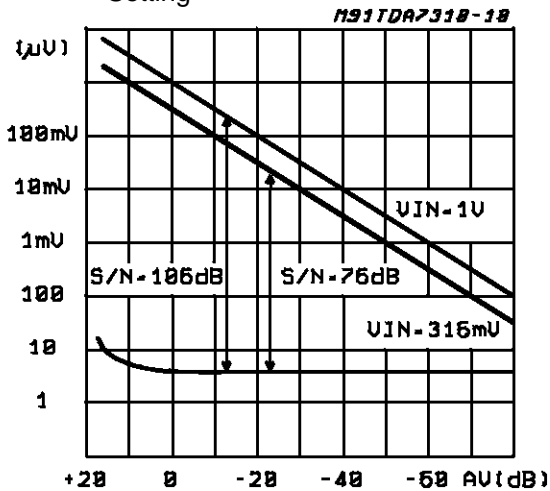

Figure 6: Distortion vs. Load Resistance

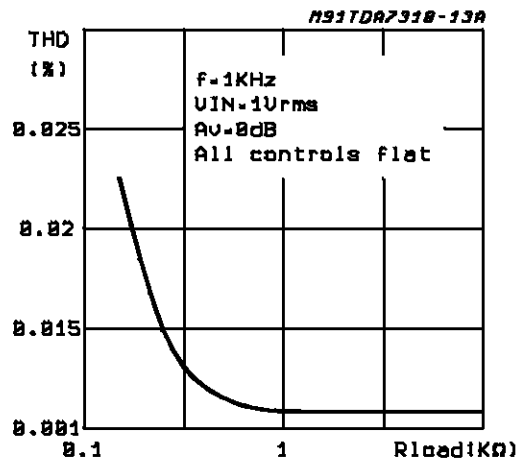

Figure 7 : Channel Separation (L → R) vs. Frequency

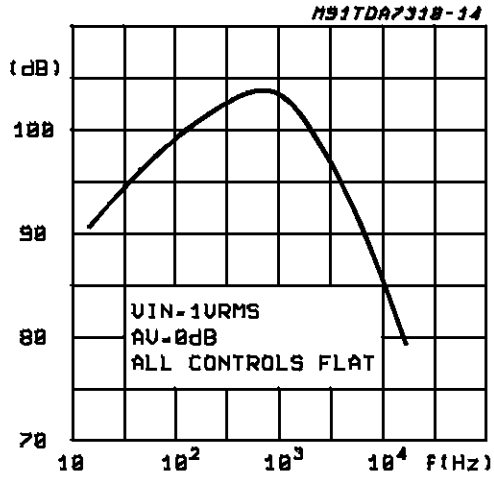

Figure 8 : Input Separation (L1 → L2, L3, L4) vs. Frequency

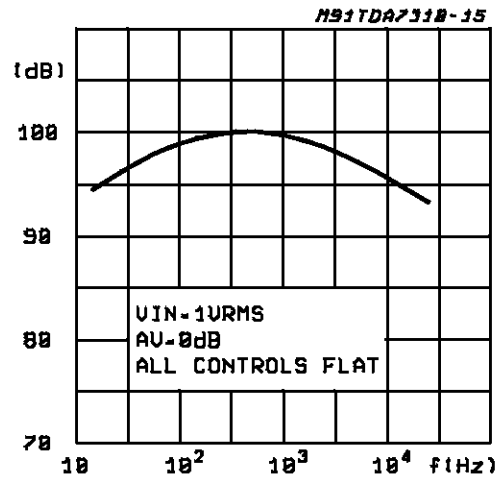

Figure 9 : Supply Voltage Rejection vs. Frequency

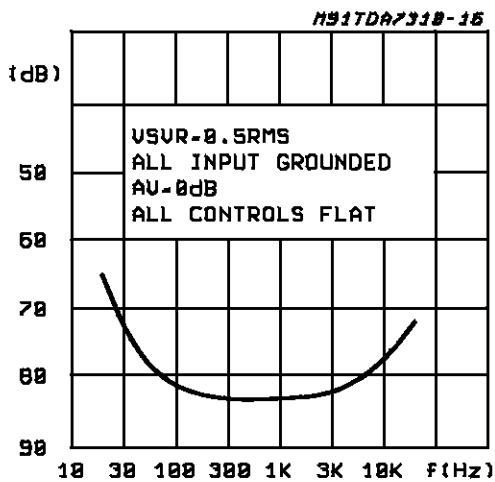

Figure 10: Output Clipping Level vs. Supply Voltage

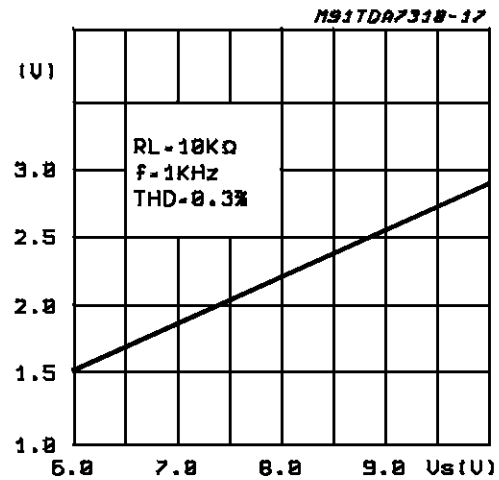

Figure 11: Quiescent Current vs. Supply Voltage

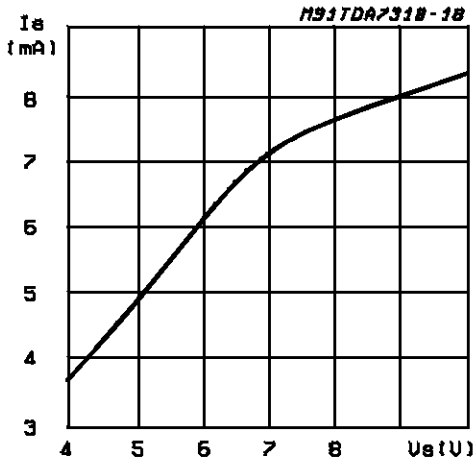

Figure 12: Supply Current vs. Temperature

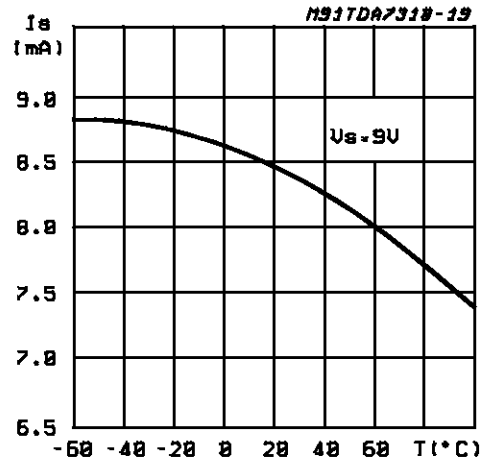

Figure 13: Bass Resistance vs. Temperature

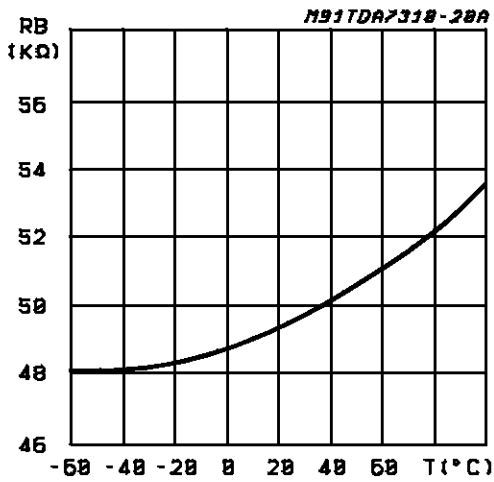
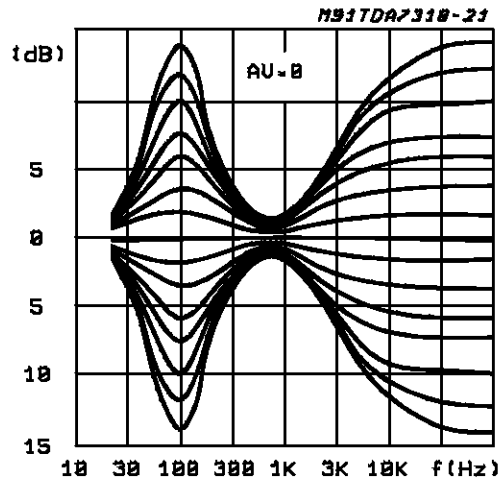

Figure 14: Typical Tone Response (with the ext. components indicated in the test circuit)



APPLICATION INFORMATION (continued)

SERIAL BUS INTERFACE

S-BUS Interface and I²C BUS Compatibility

Data transmission from microprocessor to the TDA7310 and viceversa takes place thru the 3-wire S-BUS interface, consisting of the three lines SDA, SCL, SEN. If SDA and SEN inputs are short-circuited together, then the TDA7310 appears as a standard I²C BUS slave.

According to I²C BUS specification the S-BUS lines are connected to a positive supply voltage via pull-up resistors.

Data Validity

As shown in fig. 15, the data on the SDA line must be stable during the high period of the clock. The HIGH and LOW state of the data line can only change when the clock signal on the SCL line is LOW.

Start and Stop Conditions

I²C BUS:

as shown in fig. 16 a start condition is a HIGH to LOW transition of the SDA line while SCL is HIGH. The stop condition is a LOW to HIGH transition of the SDA line while SCL is HIGH.

S-bus:

the start/stop conditions (points 1 and 6) are detected exclusively by a transition of the SEN line (1 → 0 / 0 → 1) while the SCL line is at the HIGH level.

The SDA line is only allowed to change during the time the SCL line is low (points 2, 3, 4, 5). after the start information (point 1) the SEN line returns to the HIGH level and remains unchanged for all the time the transmission is performed.

Byte Format

Every byte transferred on the SDA line must contain 8 bits. Each byte must be followed by an acknowledge bit. The MSB is transferred first.

Acknowledge

The master (μP) puts a resistive HIGH level on

Figure 15: Data Validity on the I²C BUS

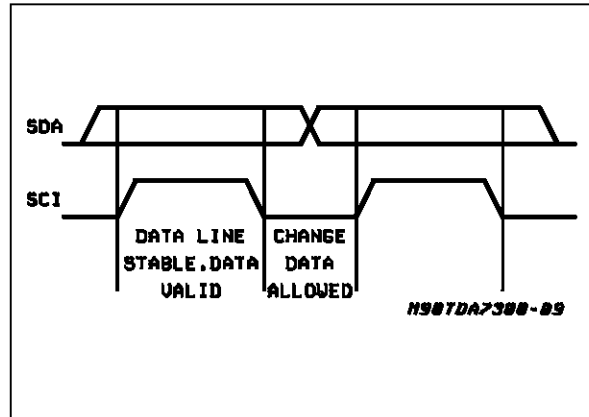
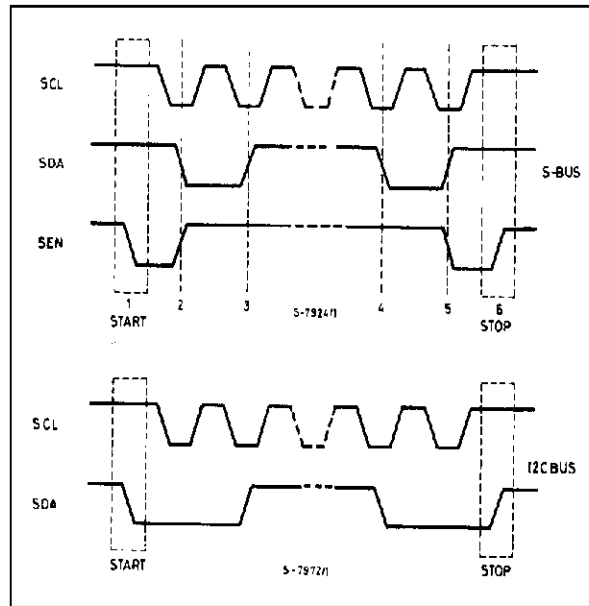
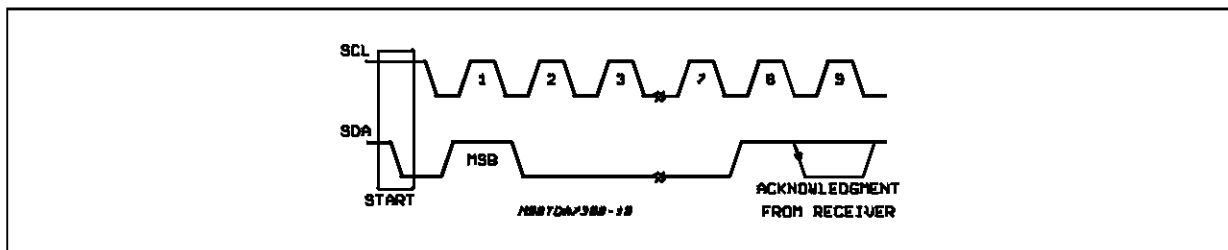

Figure 16: Timing Diagram of S-BUS and I²C BUS



the SDA line during the acknowledge clock pulse (see fig. 17). The peripheral (audioprocessor) that acknowledges has to pull-down (LOW) the SDA line during the acknowledge clock pulse, so that the SDA line is stable LOW during this clock.

Figure 17: Acknowledge on the I²C BUS



APPLICATION INFORMATION (continued)

The audioprocessor which has been addressed has to generate an acknowledge after the reception of each byte, otherwise the SDA line remains at the HIGH level during the ninth clock pulse time. In this case the master transmitter can generate the STOP information in order to abort the transfer.

Transmission without Acknowledge

Avoiding to detect the acknowledge of the audioprocessor, the μ P can use a simpler transmission: simply it waits one clock without checking the slave acknowledging, and sends the new data.

This approach of course is less protected from misworking and decreases the noise immunity.

Interface Protocol

The interface protocol comprises:

- A start condition (s)
- A chip address byte, containing the TDA7310 address (the 8th bit of the byte must be 0). The TDA7310 must always acknowledge at the end of each transmitted byte.
- A sequence of data (N-bytes + acknowledge)
- A stop condition (P)

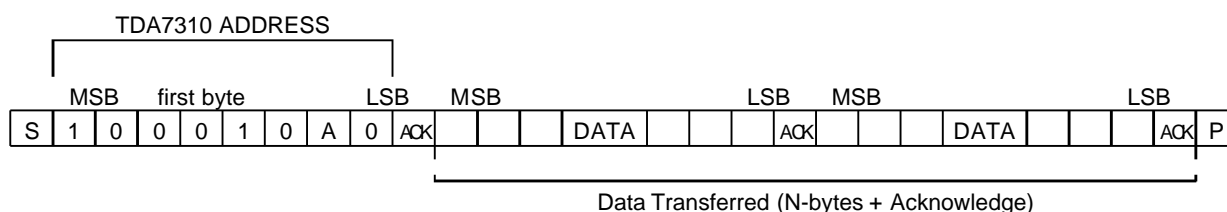

ACK = Acknowledge

S = Start

P = Stop

MAX CLOCK SPEED 100kbts/s

SOFTWARE SPECIFICATION

Chip address

1	0	0	0	1	0	A	0
MSB							LSB

A = LOGIC LEVEL ON PIN ADDR

DATA BYTES

MSB									LSB	FUNCTION
0	0	B2	B1	B0	A2	A1	A0	A0	Volume control	
1	1	0	B1	B0	A2	A1	A0	A0	Speaker ATT LR	
1	1	1	B1	B0	A2	A1	A0	A0	Speaker ATT RR	
1	0	0	B1	B0	A2	A1	A0	A0	Speaker ATT LF	
1	0	1	B1	B0	A2	A1	A0	A0	Speaker ATT RF	
0	1	0	G1	G0	S2	S1	S0	S0	Audio switch	
0	1	1	0	C3	C2	C1	C0	C0	Bass control	
0	1	1	1	C3	C2	C1	C0	C0	Treble control	

Ax = 1.25dB steps; Bx = 10dB steps; Cx = 2dB steps; Gx = 6.25dB steps

STATUS AFTER POWER ON RESET

Volume	-77.5dB
speaker	-37.5dB
audio Switch	Stereo 5
bass	+2dB
treble	+2dB
gain	0dB

TDA7310

SOFTWARE SPECIFICATION (continued)

DATA BYTES (detailed description)

Volume

MSB					LSB			FUNCTION
0	0	B2	B1	B0	A2	A1	A0	Volume 1.25dB steps
					0	0	0	0
					0	0	1	-1.25
					0	1	0	-2.5
					0	1	1	-3.75
					1	0	0	-5
					1	0	1	-6.25
					1	1	0	-7.5
					1	1	1	-8.75
0	0	B2	B1	B0	A2	A1	A0	Volume 10dB steps
		0	0	0				0
		0	0	1				-10
		0	1	0				-20
		0	1	1				-30
		1	0	0				-40
		1	0	1				-50
		1	1	0				-60
		1	1	1				-70

For example a volume of -45dB is given by:

0 0 1 0 0 1 0 0

Speaker Attenuators

MSB					LSB			FUNCTION
1	0	0	B1	B0	A2	A1	A0	Speaker LF
1	0	1	B1	B0	A2	A1	A0	Speaker RF
1	1	0	B1	B0	A2	A1	A0	Speaker LR
1	1	1	B1	B0	A2	A1	A0	Speaker RR
					0	0	0	0
					0	0	1	-1.25
					0	1	0	-2.5
					0	1	1	-3.75
					1	0	0	-5
					1	0	1	-6.25
					1	1	0	-7.5
					1	1	1	-8.75
		0	0					0
		0	1					-10
		1	0					-20
		1	1					-30
		1	1	1	1	1	1	Mute

For example attenuation of 25dB on speaker RF is given by:

1 0 1 1 0 1 0 0

Audio Switch

MSB							LSB	FUNCTION
0	1	0	G1	G0	S2	S1	S0	Audio Switch
					0	0	0	Stereo 1
					0	0	1	Stereo 2
					0	1	0	Stereo 3
					0	1	1	Stereo 4
					1	0	0	Stereo 5
					1	0	1	Not allowed
					1	1	0	Not allowed
					1	1	1	Not allowed
			0	0				+18.75dB
			0	1				+12.5dB
			1	0				+6.25dB
			1	1				0dB

For example to select the stereo 2 input with a gain of +12.5dB the 8bit string is:

0 1 0 0 1 0 0 1

Bass and Treble

0	1	1	0	C3	C2	C1	C0	Bass
0	1	1	1	C3	C2	C1	C0	Treble
				0	0	0	0	-14
				0	0	0	1	-12
				0	0	1	0	-10
				0	0	1	1	-8
				0	1	0	0	-6
				0	1	0	1	-4
				0	1	1	0	-2
				0	1	1	1	0
				1	1	1	1	0
				1	1	1	0	2
				1	1	0	1	4
				1	1	0	0	6
				1	0	1	1	8
				1	0	1	0	10
				1	0	0	1	12
				1	0	0	0	14

C3 = Sign

For example Bass at -10dB is obtained by the following 8 bit string:

0 1 1 0 0 0 1 0

Purchase of I²C Components from SGS-THOMSON Microelectronics, conveys a license under the Philips I²C Patent Rights to use these components in an I²C system, provided that the system conforms to the I²C Standard Specifications as defined by Philips.

PQFP44 (10 x 10) PACKAGE MECHANICAL DATA

DIM.	mm			inch		
	MIN.	TYP.	MAX.	MIN.	TYP.	MAX.
A			2.45			0.096
A1	0.25			0.010		
A2	1.95	2.00	2.10	0.077	0.079	0.083
B	0.30		0.45	0.012		0.018
c	0.13		0.23	0.005		0.009
D	12.95	13.20	13.45	0.51	0.52	0.53
D1	9.90	10.00	10.10	0.390	0.394	0.398
D3		8.00			0.315	
e		0.80			0.031	
E	12.95	13.20	13.45	0.510	0.520	0.530
E1	9.90	10.00	10.10	0.390	0.394	0.398
E3		8.00			0.315	
L	0.65	0.80	0.95	0.026	0.031	0.037
L1		1.60			0.063	
K	0°(min.), 7°(max.)					

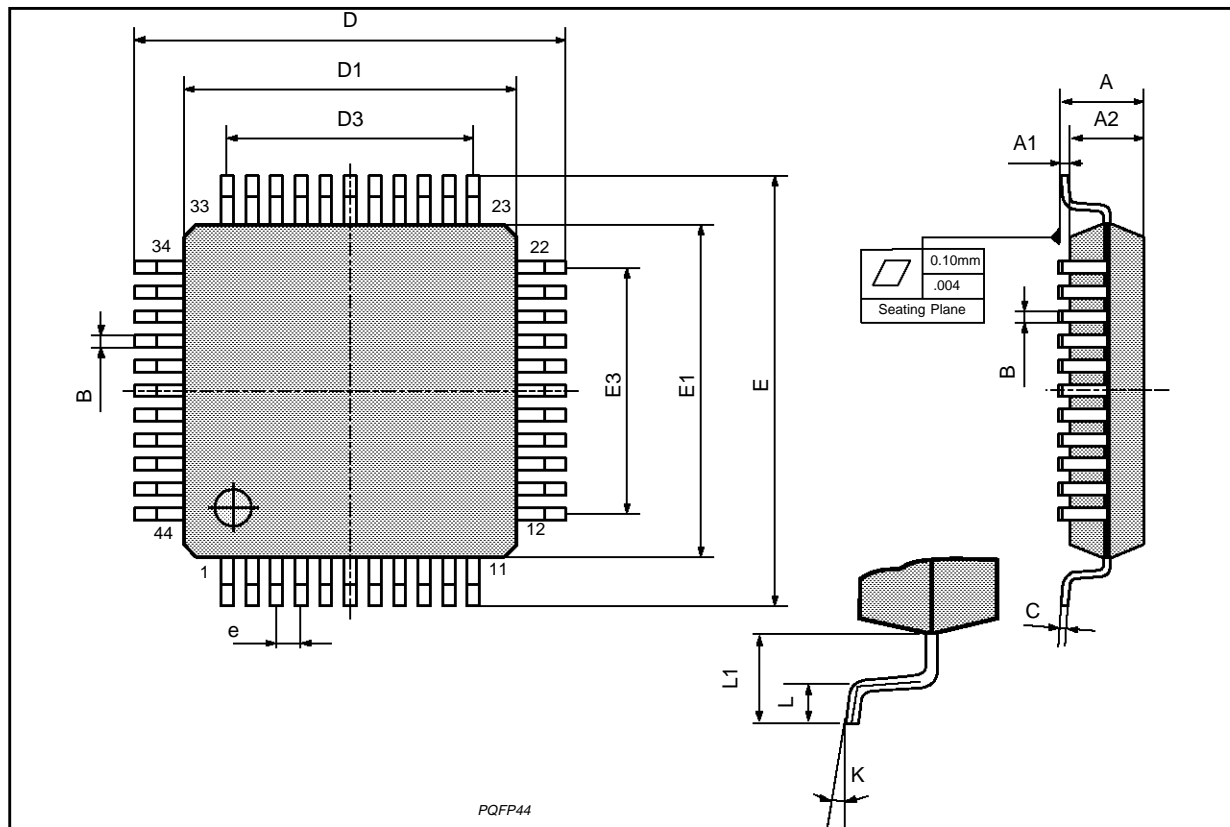

Information furnished is believed to be accurate and reliable. However, SGS-THOMSON Microelectronics assumes no responsibility for the consequences of use of such information nor for any infringement of patents or other rights of third parties which may result from its use. No license is granted by implication or otherwise under any patent or patent rights of SGS-THOMSON Microelectronics. Specifications mentioned in this publication are subject to change without notice. This publication supersedes and replaces all information previously supplied. SGS-THOMSON Microelectronics products are not authorized for use as critical components in life support devices or systems without express written approval of SGS-THOMSON Microelectronics.

© 1995 SGS-THOMSON Microelectronics - All Rights Reserved

SGS-THOMSON Microelectronics GROUP OF COMPANIES

Australia - Brazil - France - Germany - Hong Kong - Italy - Japan - Korea - Malaysia - Malta - Morocco - The Netherlands - Singapore - Spain - Sweden - Switzerland - Taiwan - Thailand - United Kingdom - U.S.A.