

DC CONTROLLED 130MHz RGB PREAMPLIFIER

- 130MHz TYPICAL BANDWIDTH AT 1V_{PP}
- 2.8ns TYP. RISE/FALL TIME (3V_{PP}/12pF LOAD)
- DC ADJUSTMENT : CONT, BRT, RGB DRIVE, RGB CUT-OFF
- COMP. VIDEO INPUT AND POSITIVE OR NEGATIVE SYNC INPUT
- INTERNAL BACKPORCH CLAMPING PULSE GENERATOR WITH 3 SELECTABLE WIDTH
- BLANKING STAGE
- INTERNAL PULSE GENERATOR FOR CUT-OFF LOOP GATING (INSIDE BLANKING)
- POSSIBILITY OF AC OR DC COUPLING TO HIGH VOLTAGE AMPLIFIER
- VOLTAGE REFERENCE GENERATOR
- POWERFULL OUTPUT DRIVE CAPABILITY
- BICMOS PROCESS



DESCRIPTION

The TDA9205 is a DC controlled wideband video amplifier intended for use in high resolution color monitor. DC (0 to 5V) contrast and brightness commands apply to the 3 channels. White balance adjustment is performed using 3 separated drive inputs. 3 feed-back inputs give a flexible DC level shift of the output signals. Cut-off adjustments can be easily performed with these 3 inputs.

Separated ground and supply for each channel and large swing output voltage (0.5 to 8V) make the TDA9205 suitable for AC or DC drive of discrete, hybrid or monolithic high voltage CRT amplifier.

Attractive functions like sync separator, line blanking, backporch generator, voltage reference generator, feed-back polarity selection give to the TDA9205 efficient features for performant and cost effective application.

PIN CONNECTIONS

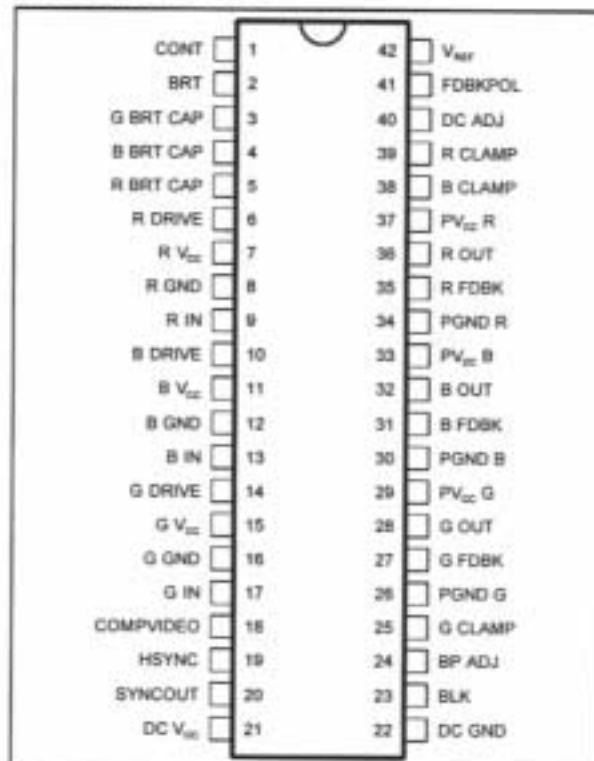

8205-01-EP8

PIN DESCRIPTION

Pin Number	Symbol	I/O	Function
1	CONT	I	Contrast Adjustment (0 to 5V)
2	BRT	I	Brightness Adjustment (0 to 5V)
3-4-5	G,B,R, BRT CAP	I	G,B,R Capacitor for Brightness Loop
6-10-14	R,B,G DRIVE	I	R,B,G Drive Adjustment
7-11-15	R,B,G V _{CC}	S	Supply Voltage of Input Stage (12V)
8-12-16	R,B,G GND	GND	Signal Ground of Input Stage
9-13-17	R,B,G IN	I	Video Signal Inputs
18	COMPVIDEO	I	Composite Video Input (or Sync on Green)
19	HSYNC	I	Horizontal Synchronization Input
20	SYNCOUT	O	Composite Sync Output
21	DC V _{CC}	S	Supply Voltage (12V)
22	DC GND	GND	Ground
23	BLK	I	Blanking Input
24	BP ADJ	I	Backporch Clamping Pulse Width Adjustment
25-28-30	R,G,B CLAMP	I	R,G,B Capacitor Clamp for Output Stage
29-31-33	R,G,B PGND	GND	Ground of Output Stage
34-36-38	R,G,B FDBK	I	Feed-back Input of Output Stage
37-39-41	R,G,B OUT	O	Video Output Signals
40-42	R,G,B PV _{CC}	S	Supply Voltage of Output Stage (12V)
43	DC ADJ	I	DC Level Adjustment of Output Signals
44	FDBKPOL	I	Selection of the Signal Polarity of the Feed-back Inputs
45	V _{REF}	O	Voltage Reference Output (5V)

BLOCK DIAGRAM

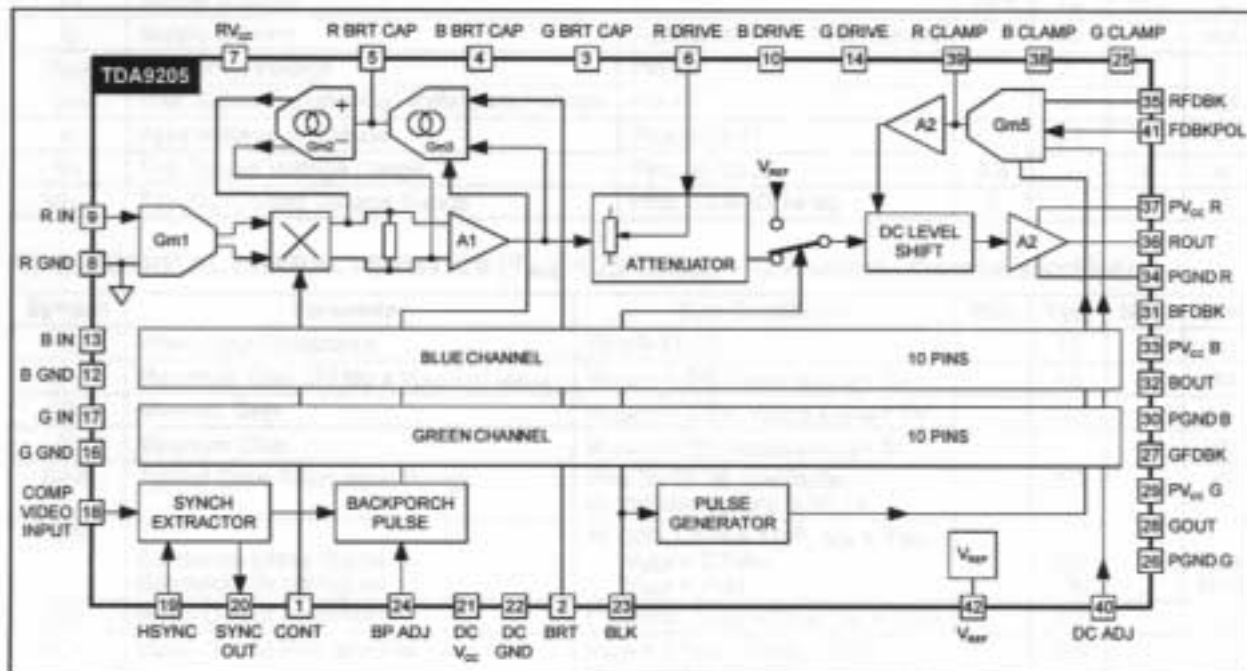

QUICK REFERENCE DATA

Symbol	Parameter	Min.	Typ.	Max.	Unit
	Signal Bandwidth (1V _{PP} /12pF load)		130		MHz
t _{ri} , t _{rf}	Rise and Fall Time (3.5V _{PP} /12pF load)		3.8		ns
	Gain Matching		0.3		dB
	Contrast Tracking		0.2		dB
	Drive Adjustment Range on the 3 Channels Separately		6		dB
	Reference Voltage		5		V
	Nominal Output Voltage (V _{IN} = 0.7V _{PP})		2.8		V
	Output Voltage (AC + DC)			8	V

8209-02 TEL

ABSOLUTE MAXIMUM RATINGS

Symbol	Parameter	Value	Unit
V _S	Supply Voltage (Pins 7-11-15-21-29-33-37)	13.5	V
I _S	Peak Video Output Sink/Source Current (Pins 28-32-36)	30	mA
V _{IN}	Voltage at any Input Pins	GND < V _{IN} < V _S	V
V _{ESD}	ESD Susceptibility (Human body model ; 100pF discharge through 1.5kΩ)	2	kV
T _{stg}	Storage Temperature	-40, +150	°C
T _J	Junction Temperature	150	°C
T _{oper}	Operating Temperature	0, +70	°C

8209-03 TEL

THERMAL DATA

Symbol	Parameter	Value	Unit
R _{th(j-a)}	Junction-ambient Thermal Resistance	Max. 60	°C/W

8209-04 TEL

DC ELECTRICAL CHARACTERISTICS (T_{amb} = 25°C, V_{CC} = 12V, unless otherwise specified)

Symbol	Parameter	Test Conditions	Min.	Typ.	Max.	Unit
V _S	Supply Voltage		10.8	12	13.2	V
I _S	Supply Current	Addition of all V _S Pins Current		75		mA
V _{REF}	Reference Voltage	Pin 42		5		V
I _{REF}	Max. Sourced Current on Reference Voltage	Pin 42		4		mA
V _i	Input Voltage Amplitude	Pins 9-13-17		0.7	1	V
V _O	Typ. Output Voltage Range	Pins 28-32-36	0.5	-	8	V
V _{ADJ}	Typ. DC Control Voltage Range	Pins 1-2-6-10-14-40	0	-	5	V

8209-05 TEL

AC ELECTRICAL CHARACTERISTICS (T_{amb} = 25°C, V_{CC} = 12V, unless otherwise specified)

Symbol	Parameter	Test Conditions	Min.	Typ.	Max.	Unit
R _{IN}	Video Input Resistance	Pins 9-13-17		15		kΩ
GM	Maximum Gain (20 log x V _{OUT AC} / V _{IN AC})	V _{CONT1} = 5V, V _{DRIVE 6-10-14} = 5V		14		dB
GN	Nominal Gain	V _{CONT1} = 2.5V, V _{DRIVE 6-10-14} = 5V		12.5		dB
GI	Minimum Gain	V _{CONT1} = 0V, V _{DRIVE 6-10-14} = 5V			-18	dB
DAR	Typical Drive Attenuation Range	Pins 28-32-36 Amplitude vs Voltage on Pins 6-10-14		6.3		dB
BW	Bandwidth Large Signal Bandwidth Small Signal	At -3dB, Load = 12pF, V _{IN} = 1V _{PP} V _{OUT} = 3.5V _{PP} V _{OUT} = 1V _{PP}		100 130		MHz MHz
DIS	Video Output Distorsion	f = 1MHz, V _{OUT} = 1V _{PP} , V _{IN} = 1V _{PP}		0.3		%
t _r , t _f	Video Output Rise and Fall Time	V _{OUT} = 3.5V _{PP} , Load = 12pF, Measured at 10/90%		2.8		ns
CT1 CT2	Crosstalk	At 1MHz At 40MHz	50	32		dB dB

8209-06 TEL

GENERAL DESCRIPTION

1- Input Stage

The R, G and B signals must be fed to the three RGB inputs through coupling capacitors (10 μ F). The maximum peak-to-peak video amplitude is 1V. In case of sync on green or composite video input signal, the IC will operate normally.

2 - Contrast Adjustment

The contrast adjustment is made by controlling simultaneously the gain of three internal variable gain amplifiers, by the DC voltage on Pin 1.

The control voltage range as for all other DC controls on TDA9205 is 0 to 5V.

The contrast adjustment allows to cover a minimum range of 30dB.

The contrast tracking (when contrast is changed) is equal to 0.2dB. Typical curve is given in Figure 1.

Figure 1 : Contrast Adjustment versus Control Voltage

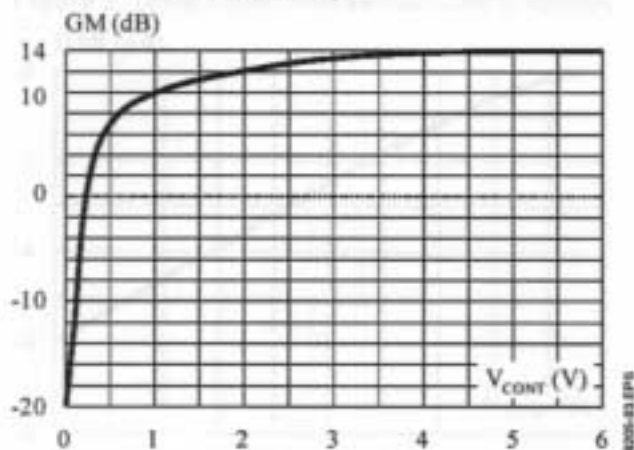

3 - Brightness Adjustment

As for the contrast adjustment, the brightness is controlled by a DC voltage applied on Pin 2.

The brightness function consists to add the same DC offset to the three RGB signals after contrast amplification.

First the DC level of A1 output is compared to the brightness command on Pin 2 by the comparator GM2. This comparison is made during the internally generated backporch clamping pulse (BP).

As shown on the Figure 2, this pulse occurs when the input video signals are at black level (after the end of sync pulse).

Figure 2

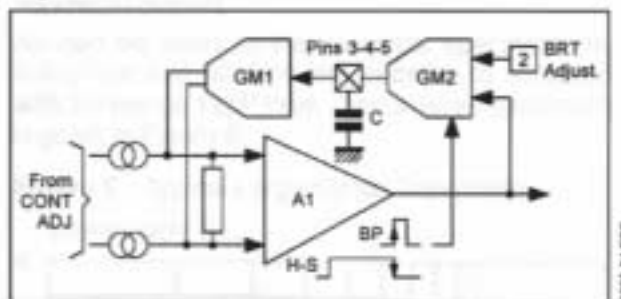

GM2 comparator have a current output which charge or discharge the memory capacitors (C), connected on the input of the transconductors (GM1).

The loop stabilize when the DC value on the output of A1 reaches the desired value setted by the DC voltage on Pin 2. The 3 Video channels works according to this description. Typical curve is given in Figure 3.

Figure 3 : Brightness Adjustment versus Control Voltage

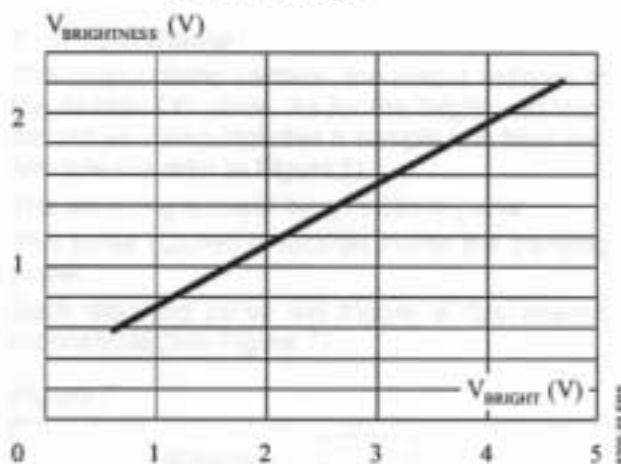

4 - Drive Adjustment

In order to make the white balance, the TDA9205 offers the possibility to adjust separately the overall gain of each complete video channel.

The gain of each channel is controlled by the DC voltage on the Pins 6-10-14.

These pins are connected to the three internal attenuators located after the contrast and brightness processing.

The attenuation range is from 0dB to -6dB.

GENERAL DESCRIPTION (continued)

0dB is achieved for 5V on drive adjustment and -6dB for 0V. Typical curves are given in Figures 4 and 5.

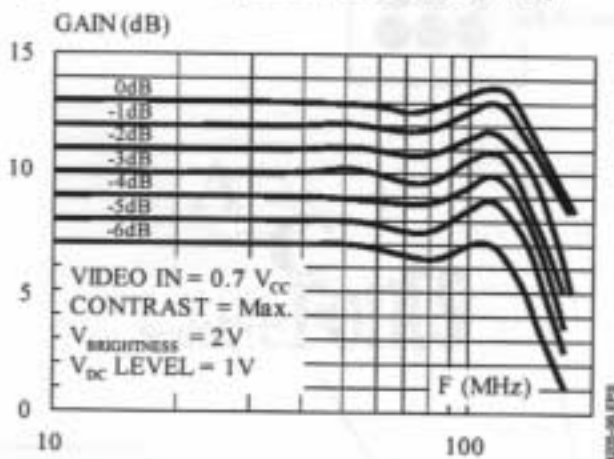
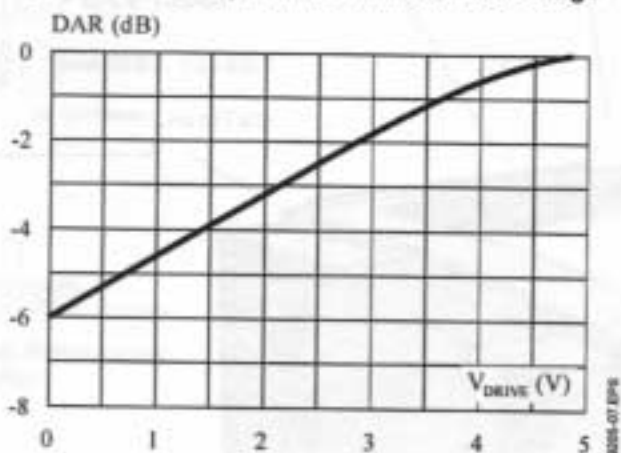
Figure 4 : Drive Adjustment versus Frequency**Figure 5** : Drive Adjustment versus Control Voltage**5 - Blanking**

The blanking stage switches the outputs to the infra black level when a positive pulse is applied on the TTL BLK input (Pin 23).

The infra black level is defined as black level minus 400mV on the video outputs.

Black level is reached with minimal brightness and black level on video signal inputs.

6 - Output Stage

The output stage allows maximum voltage range (between 0.5 and 8V).

To allow the TDA9205 to drive either discrete (with cascade stage) or hybrid or monolithic high voltage amplifier, the output has been designed to be able to drive either capacitive or resistive load.

The three outputs are able to sink or source 30mA maximum current.

As can be seen in the electrical specifications, 3.8ns rise and fall time are possible to achieved with 3.5V_{PP} on 12pF load. Typical large bandwidth is given in Figure 6.

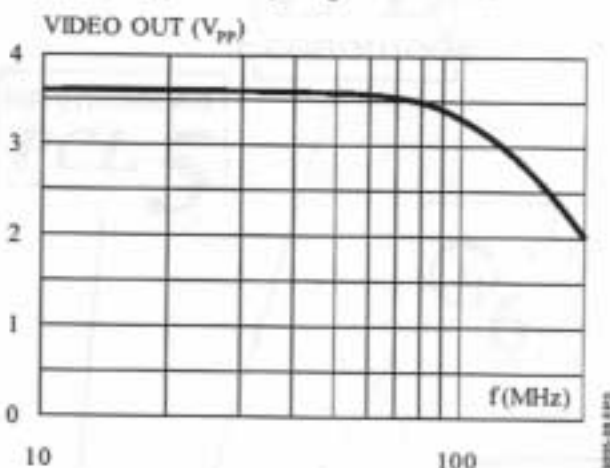
Figure 6 : Typical Large Signal Bandwidth**7 - Output Clamp**

The output clamp centers the output voltages to the desired DC value. As for the brightness loop, the output clamp includes a sample and hold system (please refer to Figure 2).

The sampling is made by an internal pulse.

This pulse (CLPP) is located inside the blanking pulse.

Each blanking pulse will trigger a 1μs internal monostable (see Figure 7).

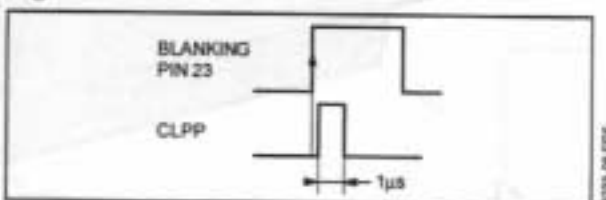
Figure 7

During CLPP, the DC voltage of Pin 40 will be compared to the Red, Green or Blue feed-back signals on Pins 35, 27 or 31.

In order to allow DC or AC coupling between high voltage amplifier and cathode, the polarity of this feed-back signal can be either positive or negative. The desired polarity is selectable by Pin 41.

If Pin 41 is at high level, the feed-back signals (Pins 27-31-35) must have positive polarity (See Figure 8a).