

SPECIFICATION

Device Name : SILICON DIODE

Type Name : YG802C04R

Spec. No. :

This material and the information herein is the property of
 Fuji Electric Co., Ltd. They shall be neither reproduced, copied,
 lent, or disclosed in any way whatsoever for the use of any
 third party nor used for the manufacturing purposes without
 the express written consent of Fuji Electric Co., Ltd.

Fuji Electric Co., Ltd.
Matsumoto Factory

	DATE	NAME	APPROVED	Fuji Electric Co., Ltd.		
DRAWN				DWG. NO.		
CHECKED						

1. SCOPE

This specification provides the ratings and the test requirement for FUJI SILICON DIODE YG802C04R

2. OUT VIEW · MARKING · MOLDING RESIN

- (1) Out view is shown
- (2) Marking is shown
It is marked to type name or abbreviated type name, polarity and Lot No.
- (3) Molding resin
Epoxy resin UL94:94V-0

3. RATINGS

3.1 MAXIMUM RATINGS

ITEM	SYMBOL	CONDITIONS	RATINGS	UNITS
Repetitive peak surge reverse voltage	V_{RSM}	$t_w=500ns, duty=1/40$	48	V
Repetitive peak reverse voltage	V_{RRM}		40	V
Isolating voltage	Viso	Terminals-to-Case, AC, 1min	1500	V
Average forward current	I_o	Square wave duty=1/2 $T_c=95^{\circ}C$	10 *	A
Non-repetitive surge current	I_{FSM}	Sine wave, 10ms	120	A
Operating junction temperature	T_j		150	$^{\circ}C$
Storage temperature	T_{stg}		-40 to +150	$^{\circ}C$

* Out put current of centertap full wave connection.

3.2 ELECTRICAL CHARACTERISTICS (at $T_a=25^{\circ}C$ unless otherwise specified.)

ITEM	SYMBOL	CONDITIONS	MAXIMUM	UNITS
Forward voltage **	V_F	$I_F = 4 A$	0.55	V
Reverse current **	I_R	$V_R = V_{RRM}$	5.0	mA
Thermal resistance	$R_{th(j-c)}$	Junction to case	3.5	$^{\circ}C/W$

** Rating per element

3.3 MECHANICAL CHARACTERISTICS

Mounting torque	Recommended torque	0.3 ~ 0.5	N · m
Weight		2.0	g

This material and the information herein is the property of Fuji Electric Co., Ltd. They shall be neither reproduced, copied, lent, or disclosed in any way whatsoever for the use of any third party nor used for the manufacturing purposes without the express written consent of Fuji Electric Co., Ltd.

Fuji Electric Co., Ltd.

DWG. NO.

H04-004-03

OUT VIEW

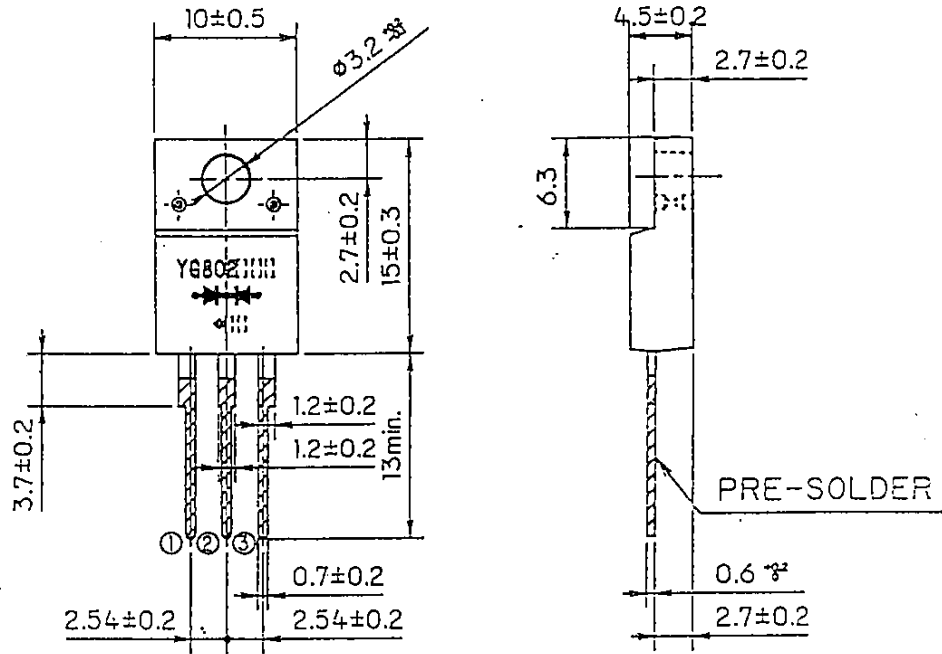

DIMENSIONS ARE IN MILLIMETERS.

MARKING

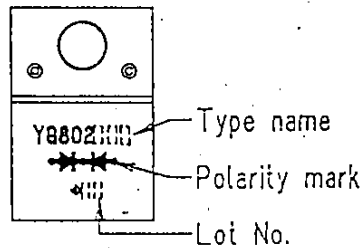

CONNECTION

YG802C

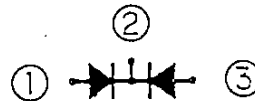

This material and the information herein is the property of Fuji Electric Co., Ltd. They shall be neither reproduced, copied, lent, or disclosed in any way whatsoever for the use of any third party nor used for the manufacturing purposes without the express written consent of Fuji Electric Co., Ltd.

Forward Characteristic (typ.)

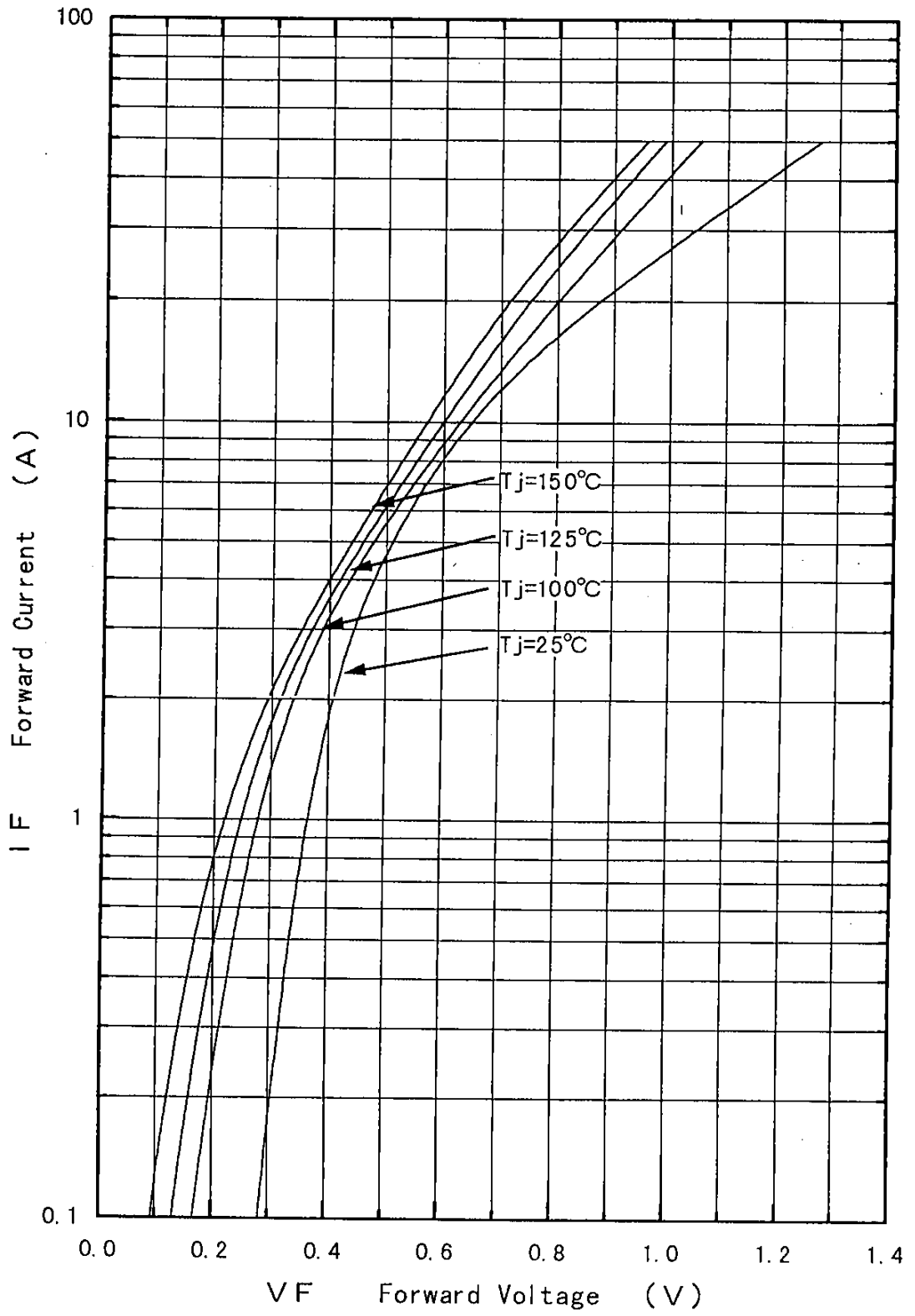

This material and the information herein is the property of Fuji Electric Co., Ltd. They shall be neither reproduced, copied, lent, or disclosed in any way whatsoever for the use of any third party nor used for the manufacturing purposes without the express written consent of Fuji Electric Co., Ltd.

REVISIONS			

DATE	NAME	APPROVED

Fuji Electric Co., Ltd.	
DWG. NO.	

Current Derating (I_o-T_c)

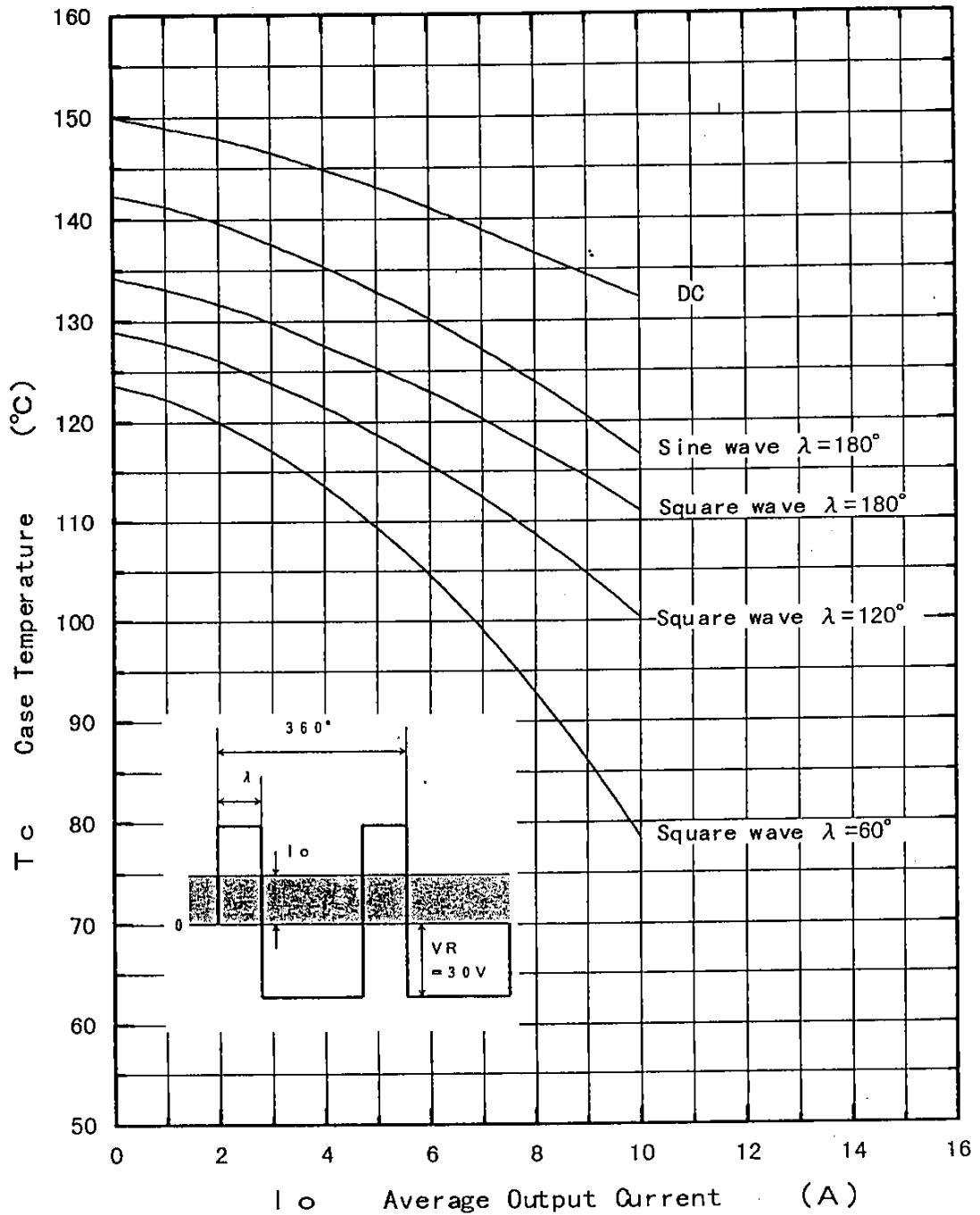

λ : Conduction angle of forward current for each rectifier element
 I_o : Output current of center-tap full wave connection

This material and the information herein is the property of Fuji Electric Co., Ltd. They shall be neither reproduced, copied, lent, or disclosed in any way whatsoever for the use of any third party nor used for the manufacturing purposes without the express written consent of Fuji Electric Co., Ltd.

	DATE	NAME	APPROVED	Fuji Electric Co., Ltd.
DRAWN				DWG. NO.
CHECKED				
REVISIONS				

MA4LE

Junction Capacitance Characteristic (typ.)

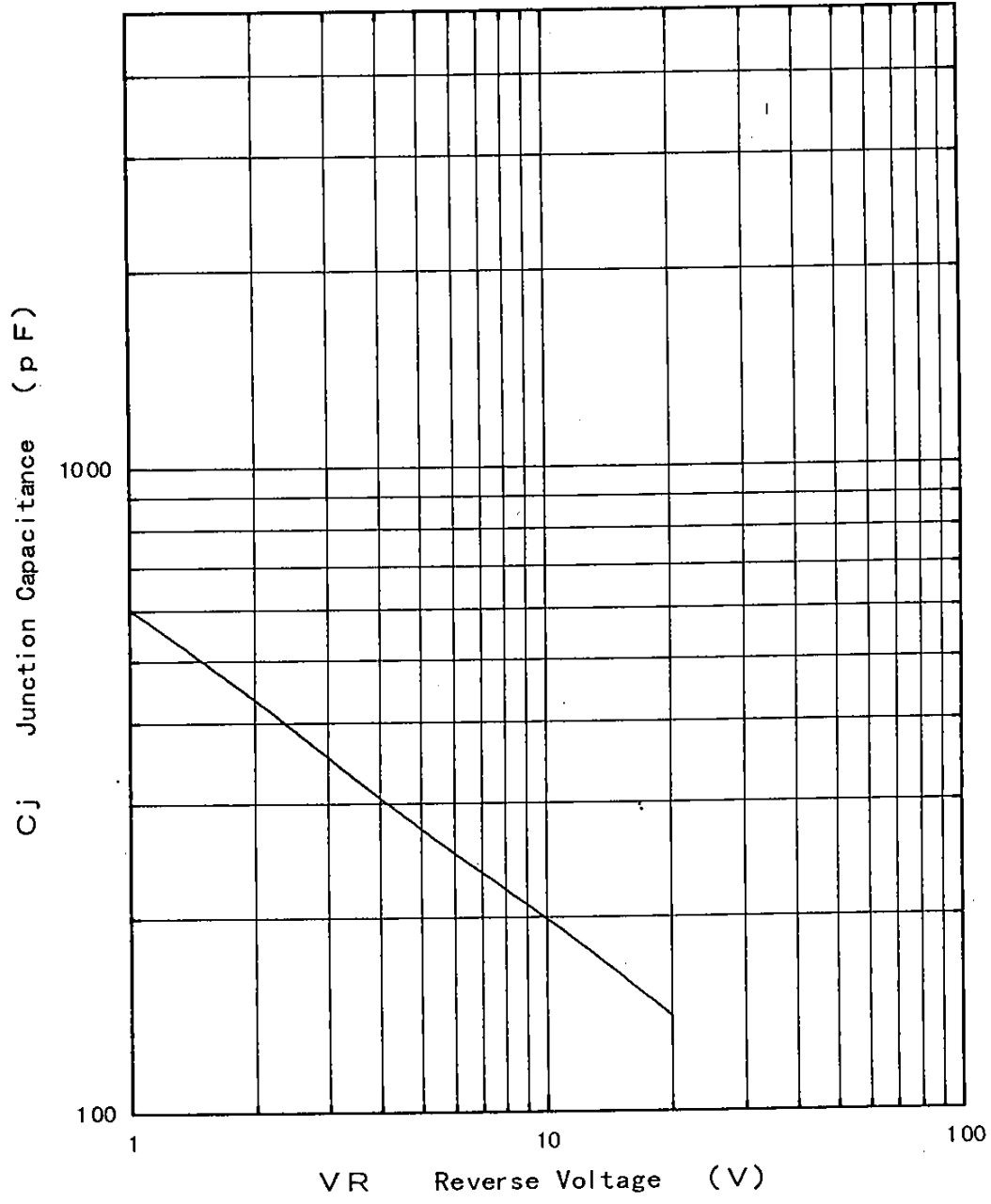

This material and the information herein is the property of Fuji Electric Co., Ltd. They shall be neither reproduced, copied, lent, or disclosed in any way whatsoever for the use of any third party nor used for the manufacturing purposes without the express written consent of Fuji Electric Co., Ltd.

REVISIONS	

	DATE	NAME	APPROVED
DRAWN			
CHECKED			

Fuji Electric Co., Ltd.	
DWG. NO.	

This material and the information herein is the property of Fuji Electric Co., Ltd. They shall be neither reproduced, copied, lent, or disclosed in any way whatsoever for the use of any third party nor used for the manufacturing purposes without the express written consent of Fuji Electric Co., Ltd.

Transient Thermal Impedance

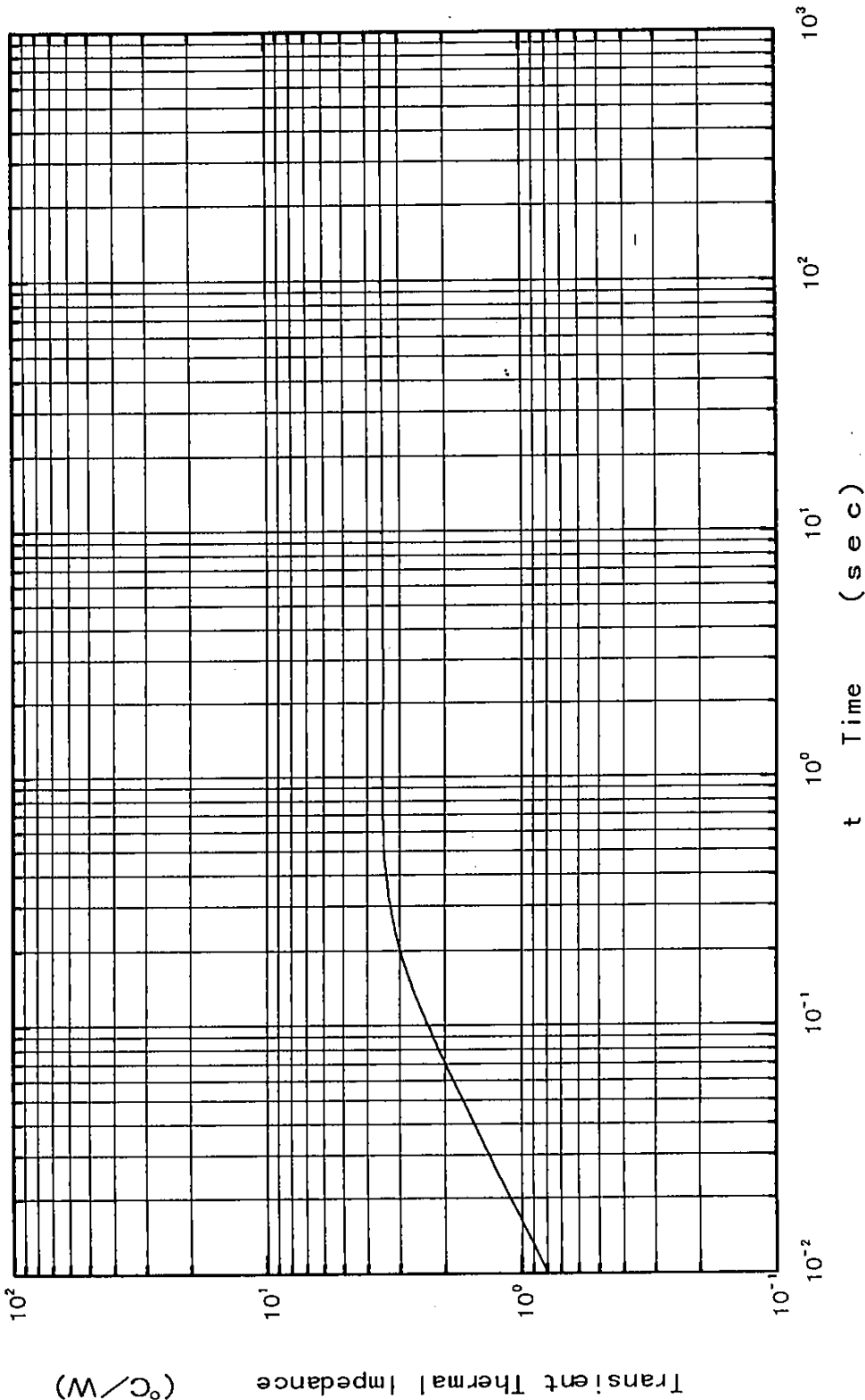

REVISIONS			

	DATE	NAME	APPROVED
DRAWN			
CHECKED			

Fuji Electric Co., Ltd.	
DWG. NO.	

MA4LE