

2MBI300N-120-01

IGBT Module

1200V / 300A 2 in one-package

■ Features

- VCE(sat) classified for easy parallel connection
- High speed switching
- Voltage drive
- Low inductance module structure

■ Applications

- Inverter for Motor drive
- AC and DC Servo drive amplifier
- Uninterruptible power supply
- Industrial machines, such as Welding machines

■ Maximum ratings and characteristics

● Absolute maximum ratings (at Tc=25°C unless otherwise specified)

Item	Symbol	Rating	Unit
Collector-Emitter voltage	V _{CEs}	1200	V
Gate-Emitter voltage	V _{GES}	±20	V
Collector current	Continuous	I _c	300
	1ms	I _c pulse	600
		-I _c	300
	1ms	-I _c pulse	600
Max. power dissipation	P _c	2100	W
Operating temperature	T _j	+150	°C
Storage temperature	T _{stg}	-40 to +125	°C
Isolation voltage	V _{is}	AC 2500 (1min.)	V
Screw torque	Mounting *1	3.5	N·m
	Terminals *2	4.5	N·m

*1 : Recommendable value : 2.5 to 3.5N·m (M5) or (M6)

*2 : Recommendable value : 3.5 to 4.5N·m (M6)

● Electrical characteristics (at Tj=25°C unless otherwise specified)

Item	Symbol	Characteristics			Conditions	Unit
		Min.	Typ.	Max.		
Zero gate voltage collector current	I _{CEs}	-	-	3.0	V _{GE} =0V, V _{CE} =1200V	mA
Gate-Emitter leakage current	I _{GES}	-	-	45	V _{CE} =0V, V _{GE} =±20V	μA
Gate-Emitter threshold voltage	V _{GE(th)}	4.5	-	7.5	V _{CE} =20V, I _c =300mA	V
Collector-Emitter saturation voltage	V _{CE(sat)}	-	-	3.3	V _{GE} =15V, I _c =300A	V
Input capacitance	C _{ies}	-	48000	-	V _{GE} =0V	pF
Output capacitance	C _{oes}	-	17400	-	V _{CE} =10V	
Reverse transfer capacitance	C _{res}	-	15480	-	f=1MHz	
Turn-on time	t _{on}	-	-	1.2	V _{CC} =600V	μs
	t _r	-	0.25	0.6	I _c =300A	
Turn-off time	t _{off}	-	-	1.5	V _{GE} =±15V	
	t _f	-	0.35	0.5	R _G =2.7ohm	
Diode forward on voltage	V _F	-	-	3.0	I _F =300A, V _{GE} =0V	V
Reverse recovery time	t _{rr}	-	-	0.35	I _F =300A	μs

● Thermal resistance characteristics

Item	Symbol	Characteristics			Conditions	Unit
		Min.	Typ.	Max.		
Thermal resistance	R _{th(j-c)}	-	-	0.06	IGBT	°C/W
	R _{th(j-c)}	-	-	0.15	Diode	°C/W
	R _{th(c-f)*}	-	0.0167	-	the base to cooling fin	°C/W

* : This is the value which is defined mounting on the additional cooling fin with thermal compound

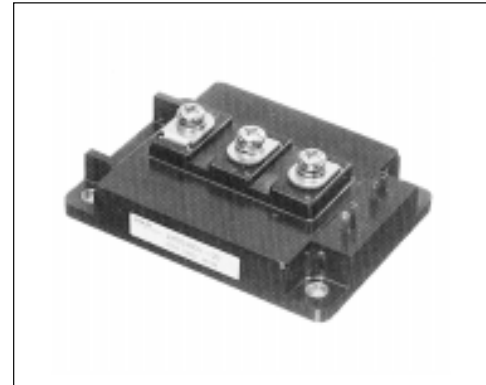

■ Equivalent Circuit Schematic

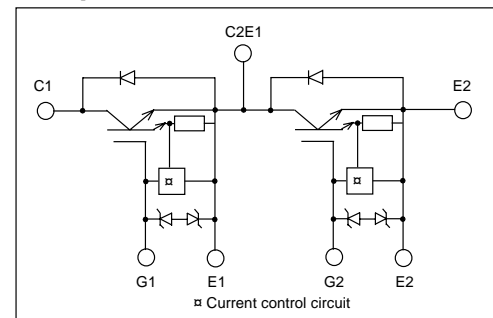

● VCE(sat) classification

Rank	Lenge	Conditions
F	2.25 to 2.50V	I _c = 300A V _{GE} = 15V T _j = 25°C
A	2.40 to 2.65V	
B	2.55 to 2.80V	
C	2.70 to 2.95V	
D	2.85 to 3.10V	
E	3.00 to 3.30V	

■ Characteristics (Representative)

Collector current vs. Collector-Emitter voltage
T_J=25°C

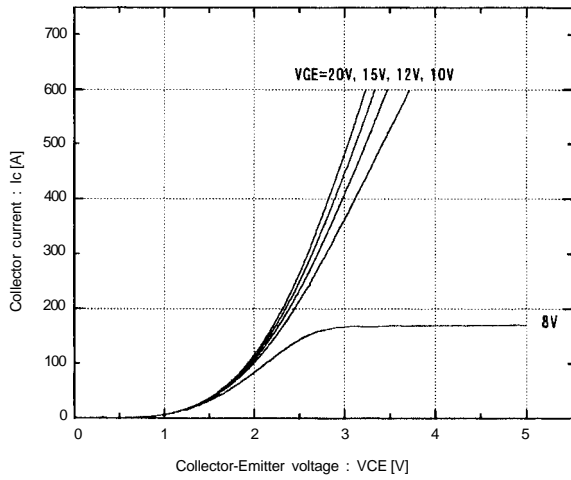

Collector current vs. Collector-Emitter voltage
T_J=125°C

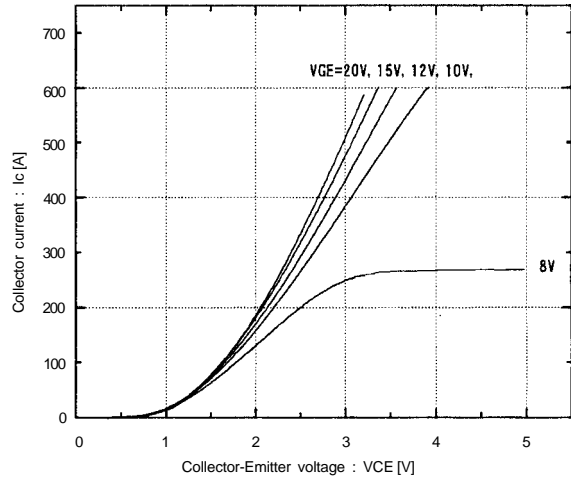

Collector-Emitter vs. Gate-Emitter voltage
T_J=25°C

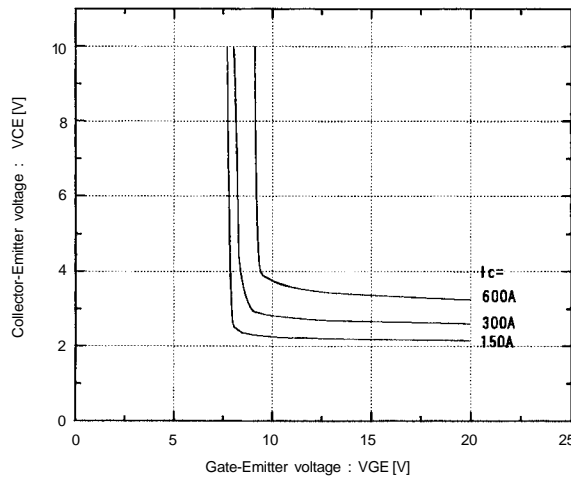

Collector-Emitter vs. Gate-Emitter voltage
T_J=125°C

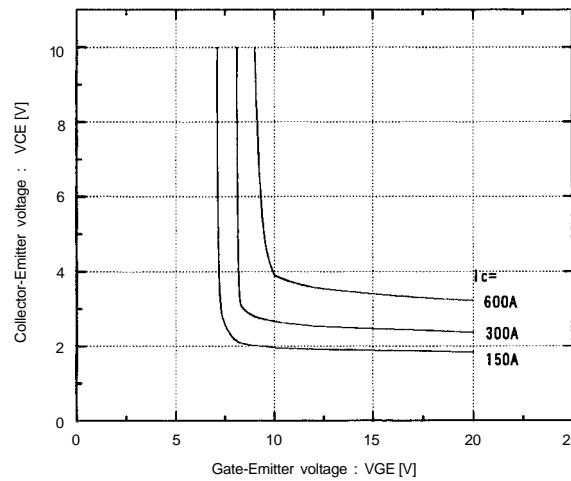

Switching time vs. Collector current
V_{CC}=600V, R_G=2.7 ohm, V_{GE}=±15V, T_J=25°C

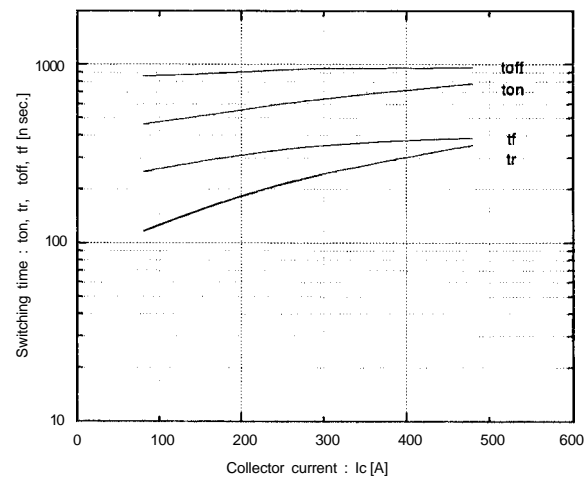

Switching time vs. Collector current
V_{CC}=600V, R_G=2.7 ohm, V_{GE}=±15V, T_J=125°C

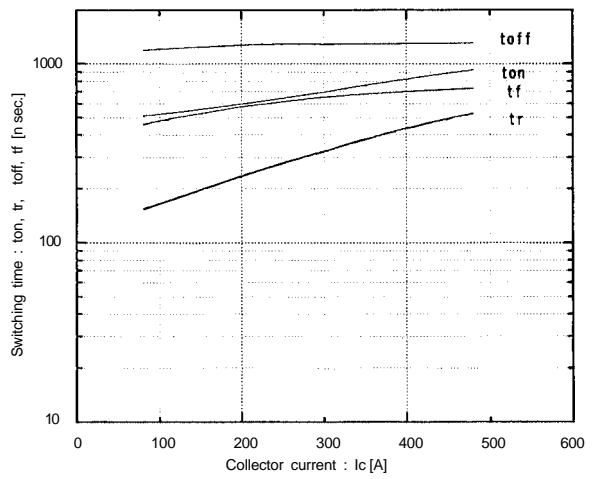

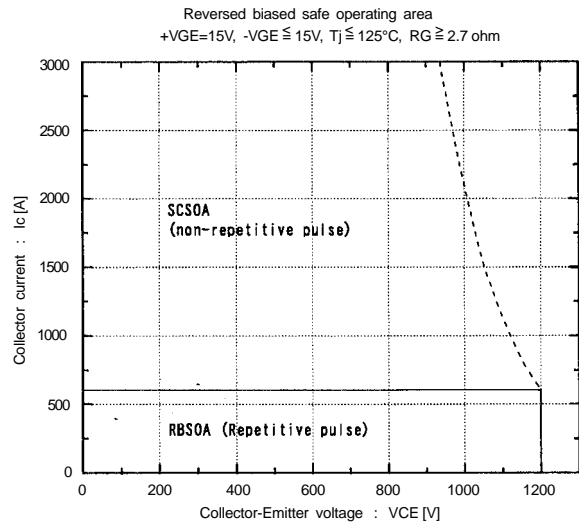
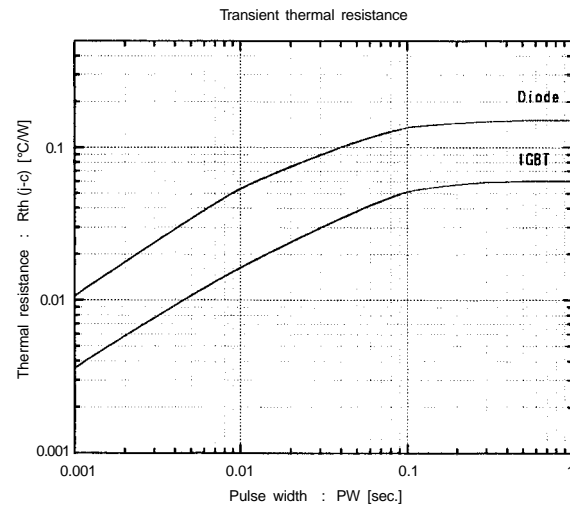
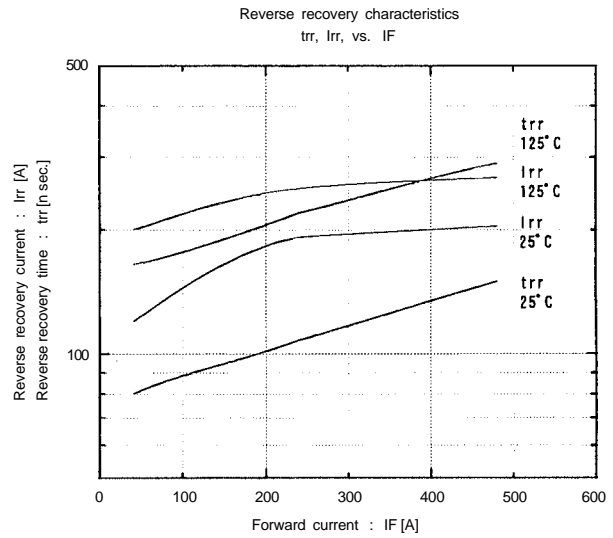
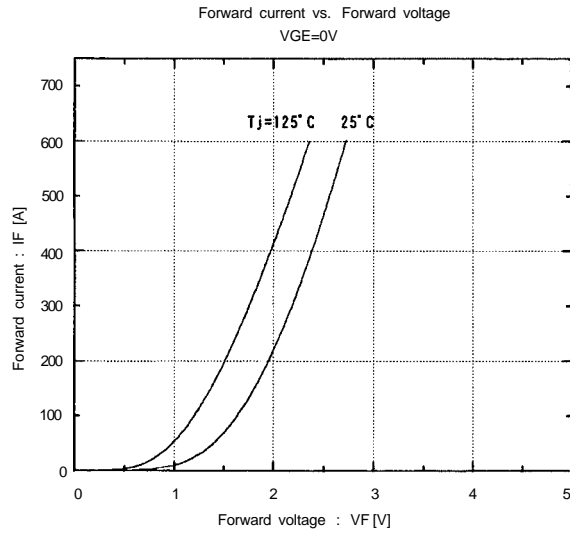
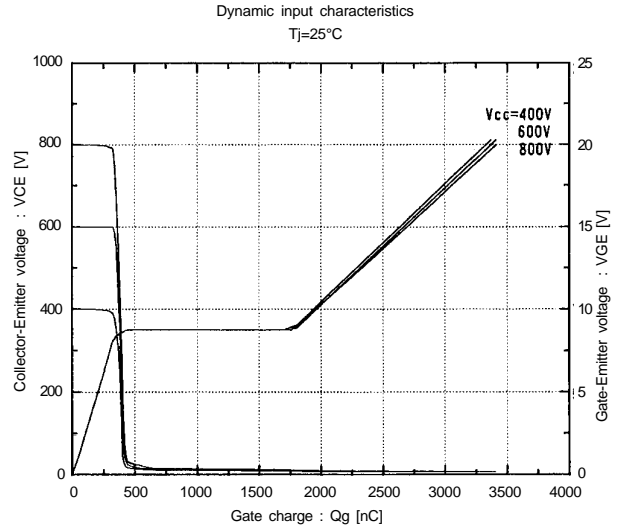
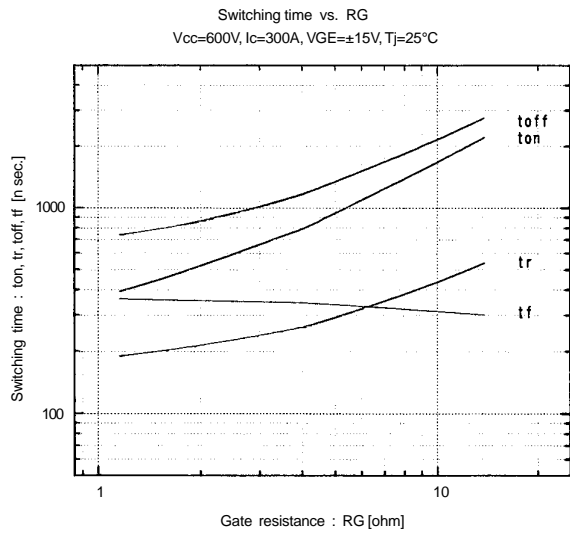

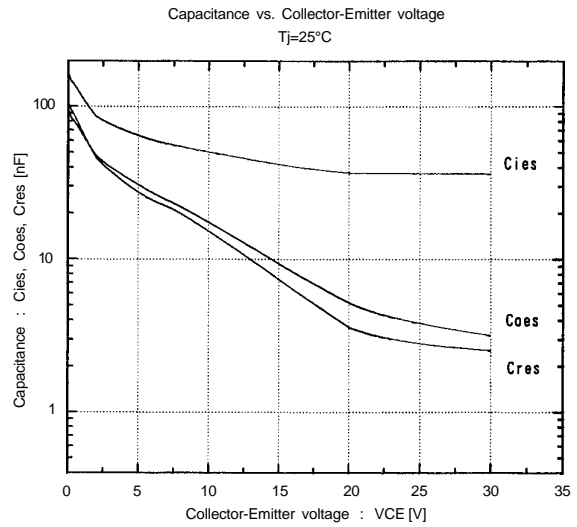
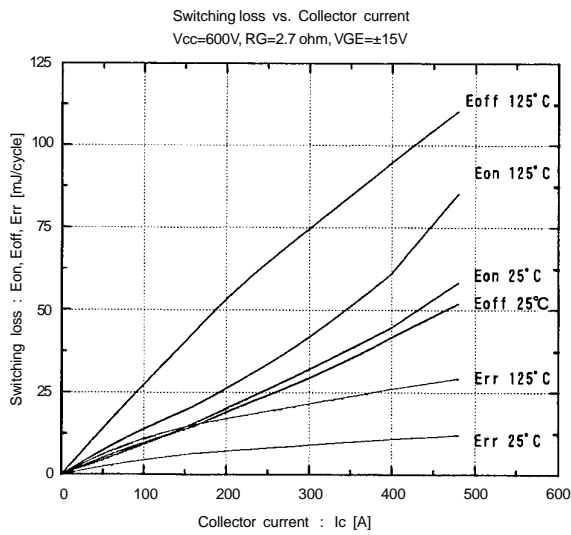

■ Outline Drawings, mm

