

2SA1880
(TP10T8)

-10A PNP

OUTLINE DIMENSIONS

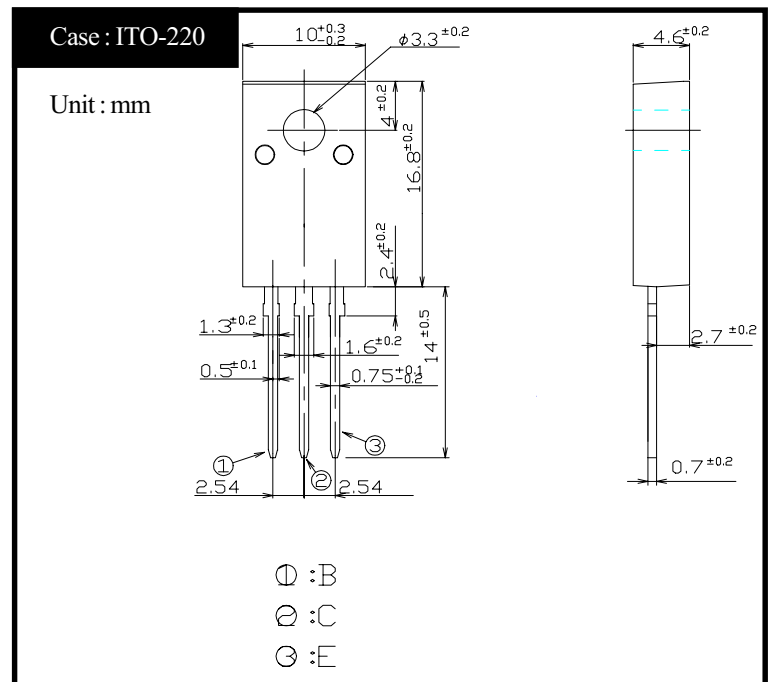

RATINGS

● Absolute Maximum Ratings

| Item | Symbol | Conditions | Ratings | Unit |
|------------------------------|-----------|-------------------------------|-----------|------|
| Storage Temperature | T_{stg} | | -55 ~ 150 | °C |
| Junction Temperature | T_j | | 150 | °C |
| Collector to Base Voltage | V_{CBO} | | -80 | V |
| Collector to Emitter Voltage | V_{CEO} | | -80 | V |
| Emitter to Base Voltage | V_{EBO} | | -7 | V |
| Collector Current DC | I_C | | -10 | A |
| Collector Current Peak | I_{CP} | | -20 | A |
| Base Current DC | I_B | | -1.5 | A |
| Base Current Peak | I_{BP} | | -2 | A |
| Total Transistor Dissipation | P_T | $T_c = 25^\circ\text{C}$ | 25 | W |
| Dielectric Strength | V_{dis} | Terminal to case, AC 1 minute | 2 | kV |
| Mounting Torque | TOR | (Recommended torque : 0.3N·m) | 0.5 | N·m |

● Electrical Characteristics ($T_c=25^\circ\text{C}$)

| Item | Symbol | Conditions | Ratings | Unit |
|---|----------------|---|----------|---------------|
| Collector to Emitter Sustaining Voltage | $V_{CEO(sus)}$ | $I_C = -0.1\text{A}$ | Min -80 | V |
| Collector Cutoff Current | I_{CBO} | At rated Voltage | Max -0.1 | mA |
| | I_{CEO} | | Max -0.1 | |
| Emitter Cutoff Current | I_{EBO} | At rated Voltage | Max -0.1 | mA |
| DC Current Gain | h_{FE} | $V_{CE} = -2\text{V}, I_C = -5\text{A}$ | Min 70 | |
| Collector to Emitter Saturation Voltage | $V_{CE(sat)}$ | $I_C = -5\text{A}$ | Max -0.3 | V |
| Base to Emitter Saturation Voltage | $V_{BE(sat)}$ | $I_B = -0.5\text{A}$ | Max -1.2 | V |
| Thermal Resistance | θ_{jc} | Junction to case | Max 5 | °C/W |
| Transition Frequency | f_T | $V_{CE} = -10\text{V}, I_C = -1\text{A}$ | TYP 50 | MHz |
| Turn on Time | t_{on} | $I_C = -5\text{A}$ $I_{B1} = -0.5\text{A}, I_{B2} = -0.5\text{A}$ $R_L = 5\Omega, V_{BB2} = -4\text{V}$ | Max 0.3 | μs |
| Storage Time | t_s | | Max 1.5 | |
| Fall Time | t_f | | Max 0.2 | |

2SA1880

$h_{FE} - I_C$

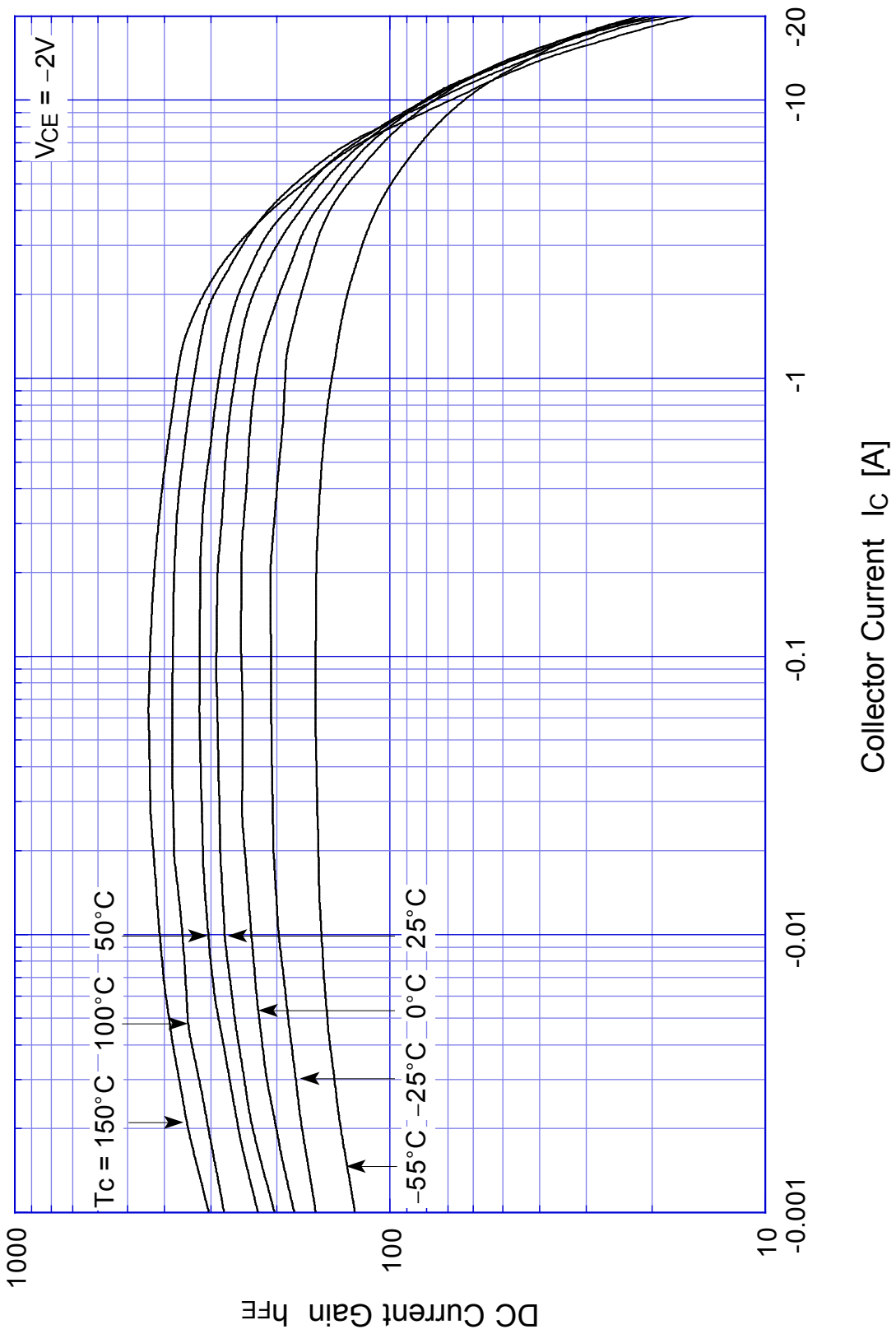

2SA1880 Saturation Voltage

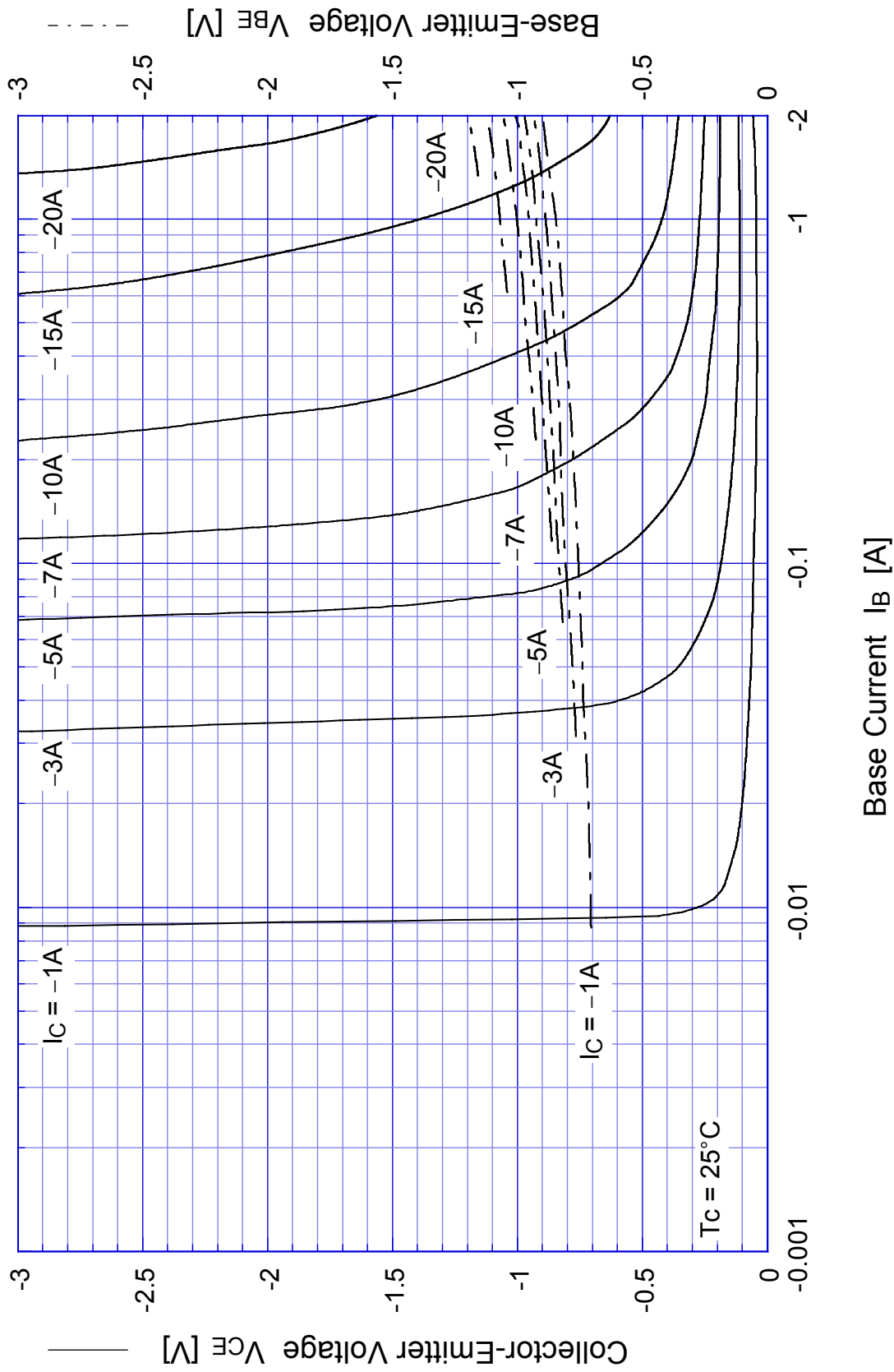

2SA1880

Switching Time - I_C

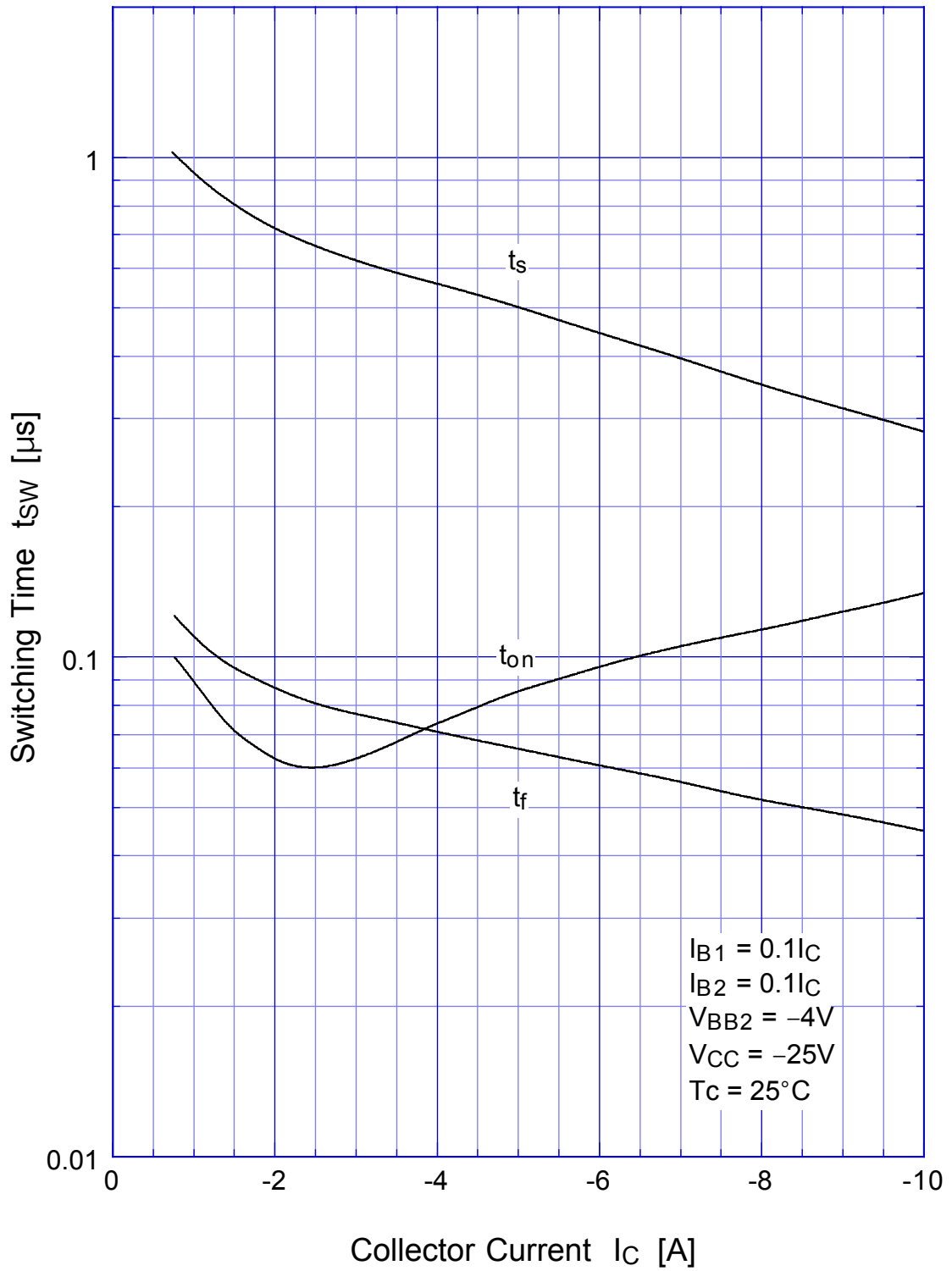

2SA1880

Switching Time - Tc

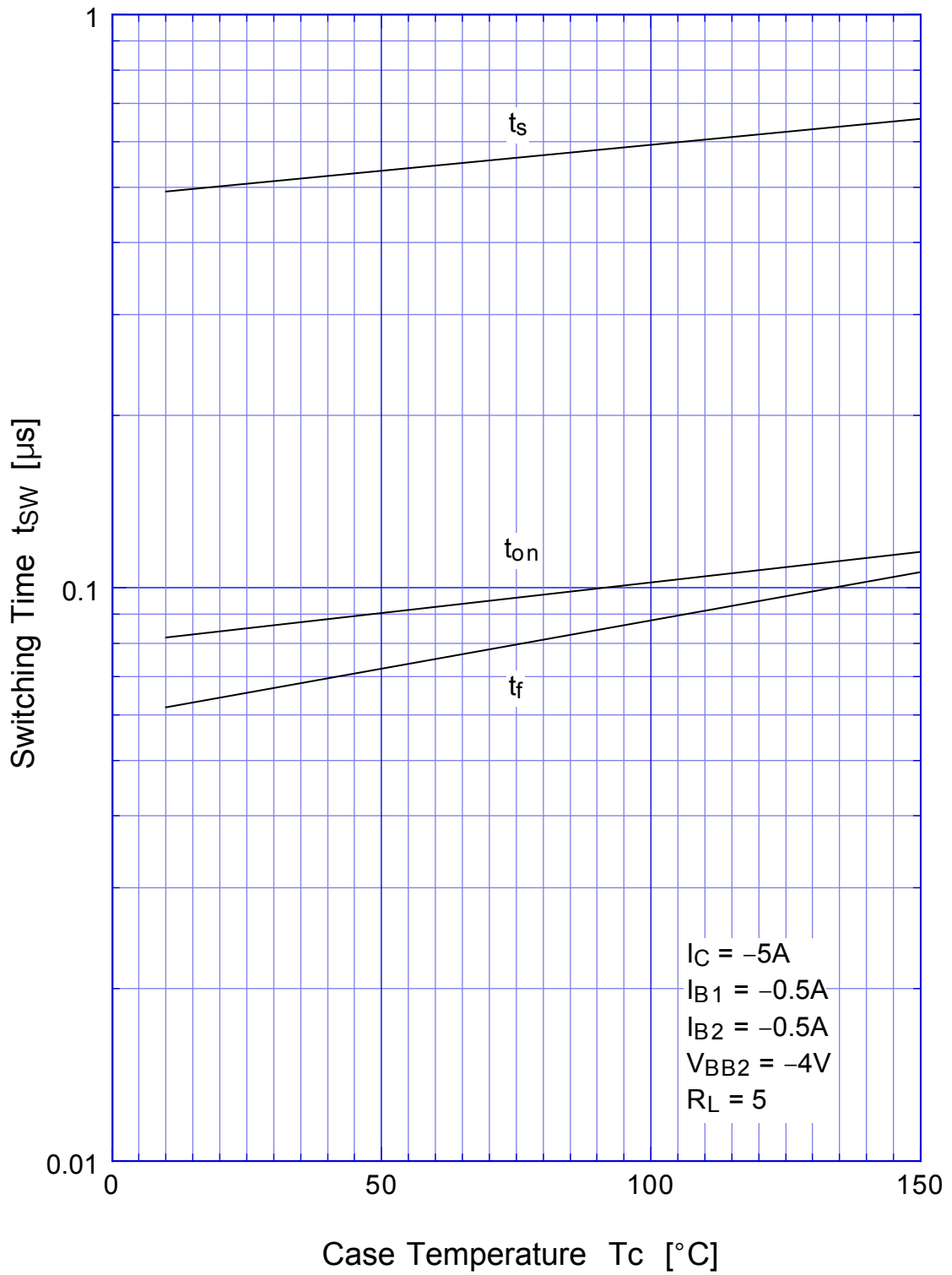

2SA1880 Transient Thermal Impedance

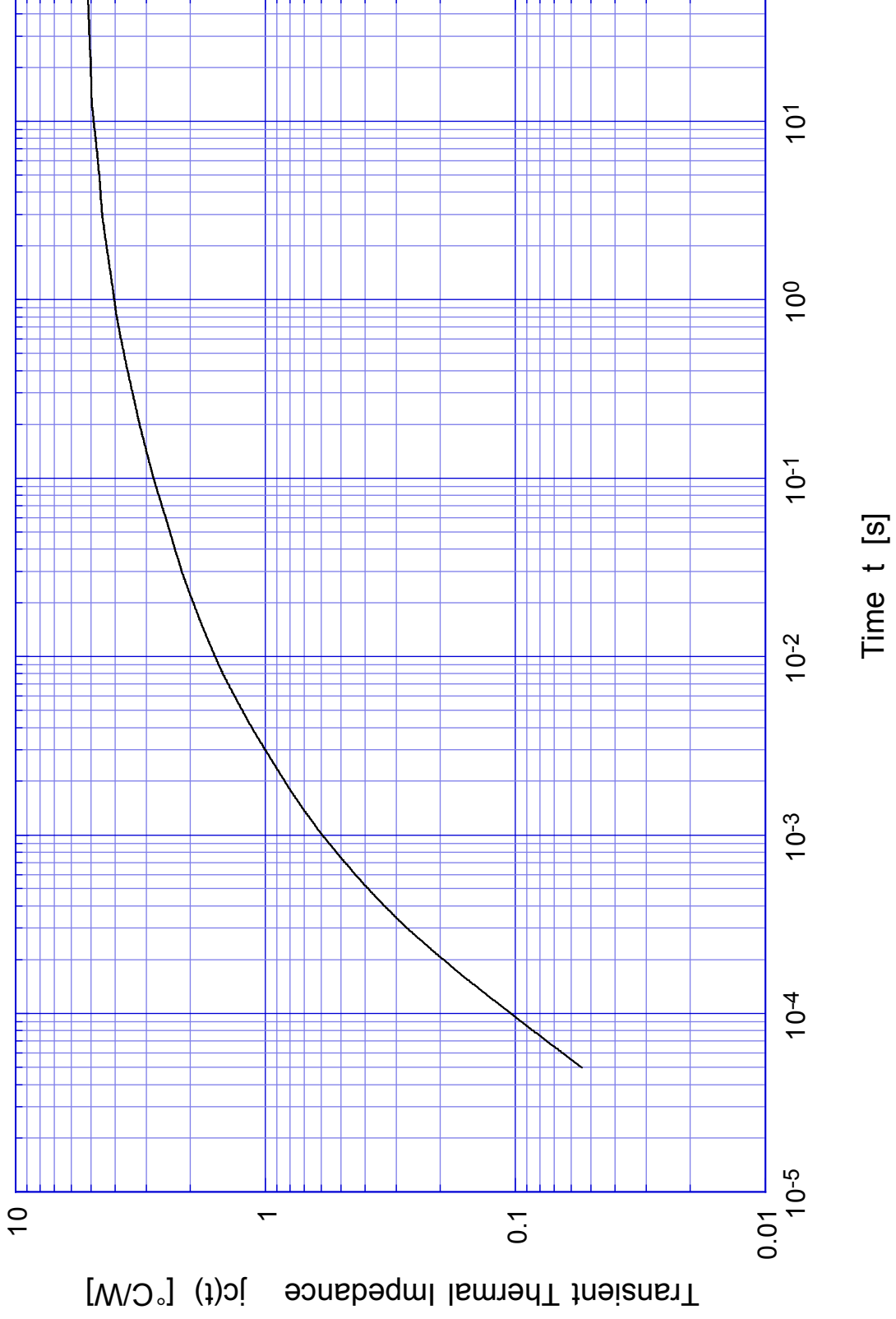

2SA1880

Forward Bias SOA

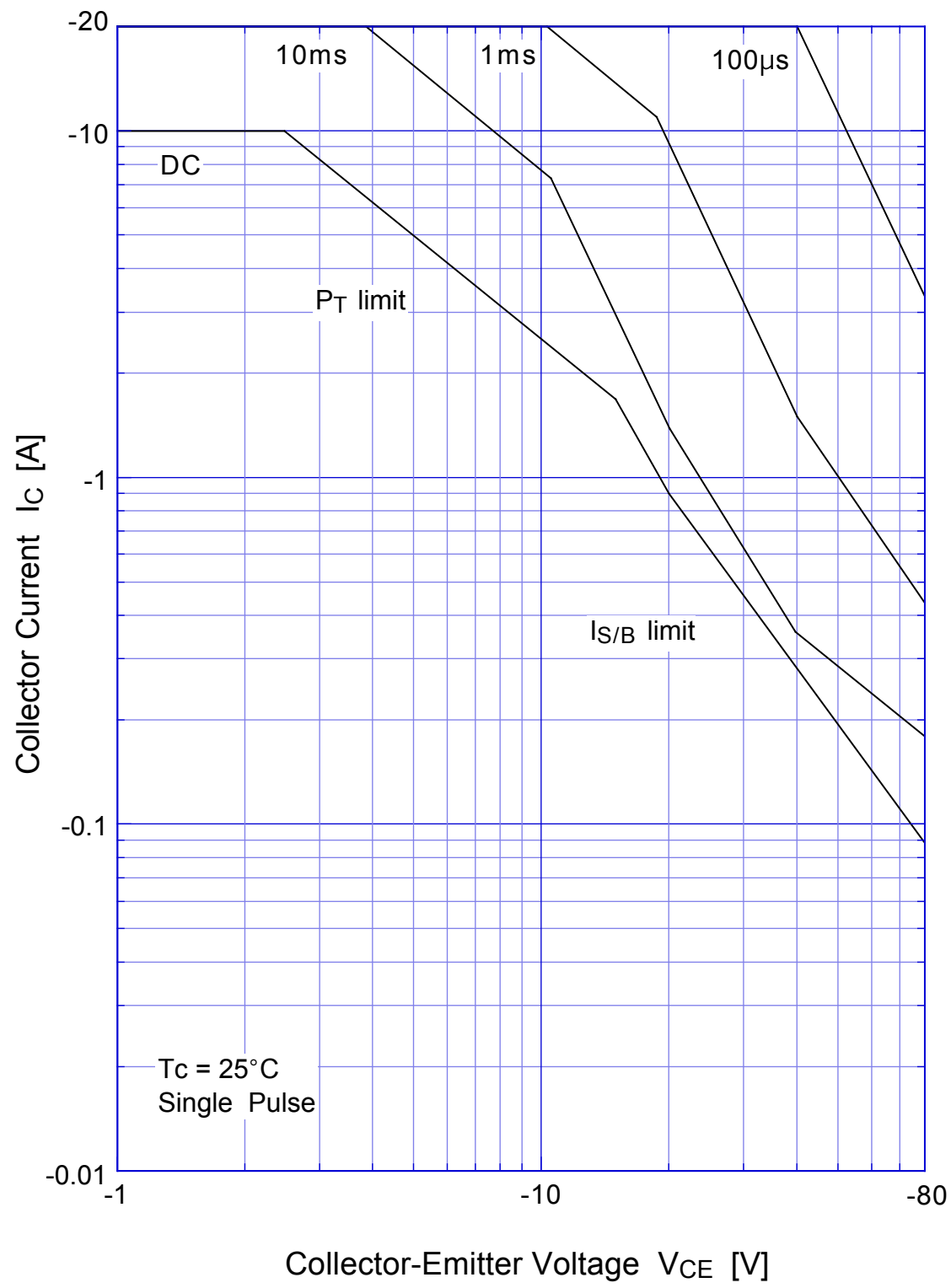

2SA1880 Collector Current Derating

