

2SC1213A (K)

SILICON NPN EPITAXIAL
 LOW FREQUENCY AMPLIFIER
 MEDIUM SPEED SWITCHING

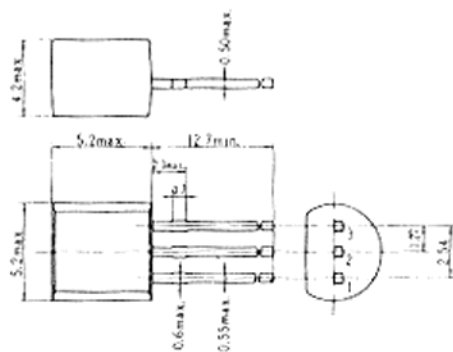

(JEDEC TO-92)

1. Emitter
 2. Collector
 3. Base
- (Dimensions in mm)

■ ABSOLUTE MAXIMUM RATINGS (Ta=25°C)

Item	Symbol	2SC1213A (K)	Unit
Collector to base voltage	V _{CB0}	50	V
Collector to emitter voltage	V _{CE0}	50	V
Emitter to base voltage	V _{EB0}	4	V
Collector current	I _C	500	mA
Collector power dissipation	P _C	400	mW
Junction temperature	T _J	150	°C
Storage temperature	T _{stg}	-55 to +150	°C

■ MAXIMUM COLLECTOR DISSIPATION CURVE

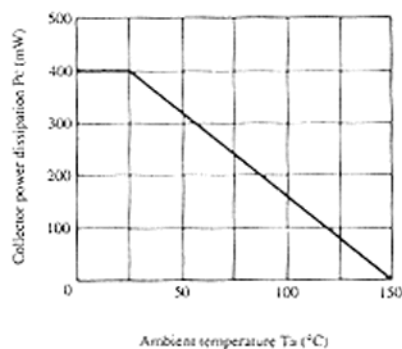

■ ELECTRICAL CHARACTERISTICS (Ta=25°C)

Item	Symbol	Test Condition	min.	typ.	max.	Unit
Collector to base breakdown voltage	V _{(BR)CBO}	I _C = 10μA, I _E = 0	50	—	—	V
Collector to emitter breakdown voltage	V _{(BR)CEO}	I _C = 1.0mA, R _{BE} = ∞	50	—	—	V
Emitter to base breakdown voltage	V _{(BR)EBO}	I _E = 10μA, I _C = 0	4	—	—	V
Collector cutoff current	I _{CBO}	V _{CB} = 20V, I _E = 0	—	—	0.5	μA
DC current transfer ratio	h _{FE} *	V _{CE} = 3V, I _C = 10mA	60	—	320	
	h _{FE}	V _{CE} = 3V, I _C = 500mA**	10	—	—	
Base to emitter voltage	V _{BE}	V _{CE} = 3V, I _C = 10mA	—	0.64	—	V
Collector to emitter saturation voltage	V _{CE(sat)}	I _C = 150mA, I _B = 15mA**	—	0.12	0.6	V
Base to emitter saturation voltage	V _{BE(sat)}	I _C = 150mA, I _B = 15mA**	—	0.83	1.2	V
Collector output capacitance	C _{ob}	V _{CB} = 10V, I _B = 0, f = 1MHz	—	7.0	—	pF
Gain bandwidth product	f _T	V _{CE} = 3V, I _C = 10mA	—	120	—	MHz
Turn on time	t _{on}	V _{CC} = 10.3V	—	0.25	—	μs
Turn off time	t _{off}	I _C = 10I _{B1} = -10I _{B2} = 10mA	—	0.85	—	μs
Storage time	t _{stg}	V _{CC} = 5V, I _C = I _{B1} = -I _{B2} = 20mA	—	0.4	—	μs

* The 2SC1213A (K) is grouped by h_{FE} as follows.

** Pulse Test

B	C	D
60 to 120	100 to 200	160 to 320

SWITCHING TIME TEST CIRCUIT

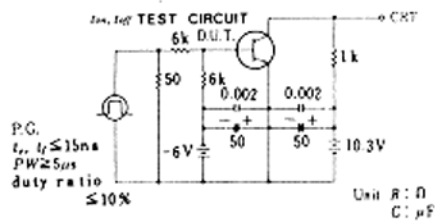

RESPONSE WAVEFORM

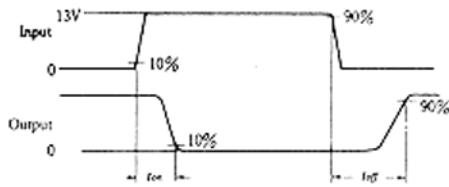

TYPICAL OUTPUT CHARACTERISTICS (1)

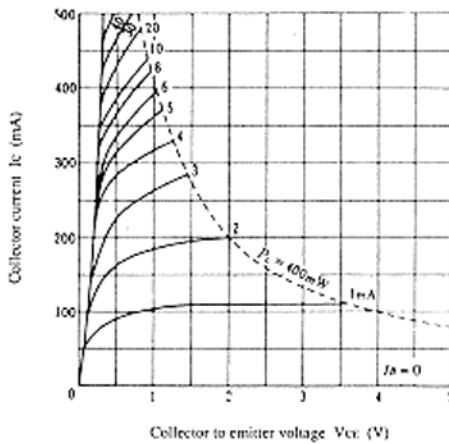

SWITCHING TIME TEST CIRCUIT

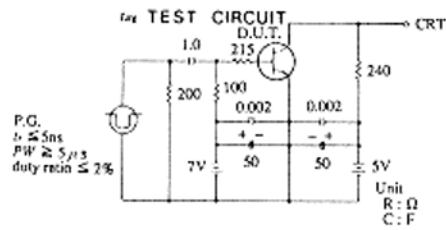

RESPONSE WAVEFORM

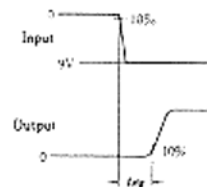

TYPICAL OUTPUT CHARACTERISTICS (2)

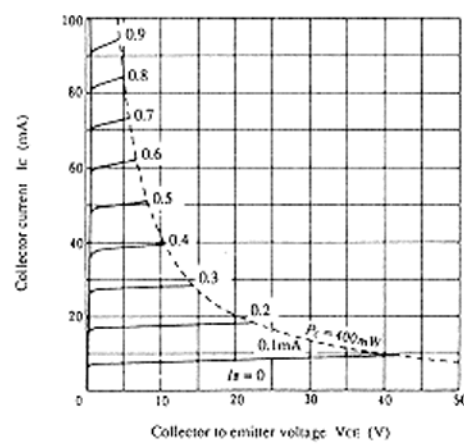

TYPICAL TRANSFER CHARACTERISTICS

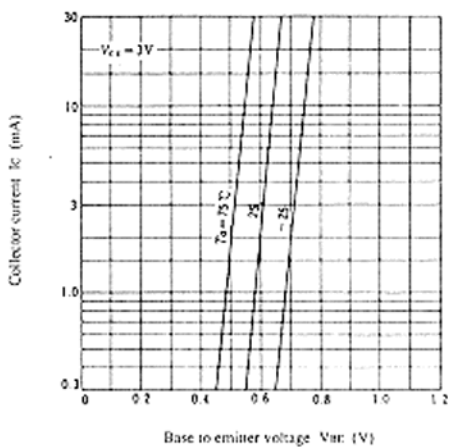

COLLECTOR CUTOFF CURRENT VS. COLLECTOR TO BASE VOLTAGE

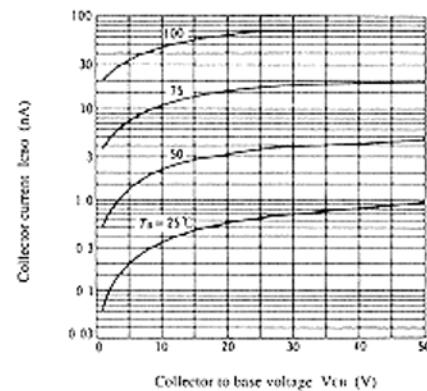

2SC1213A(K)

DC CURRENT TRANSFER RATIO VS. COLLECTOR CURRENT

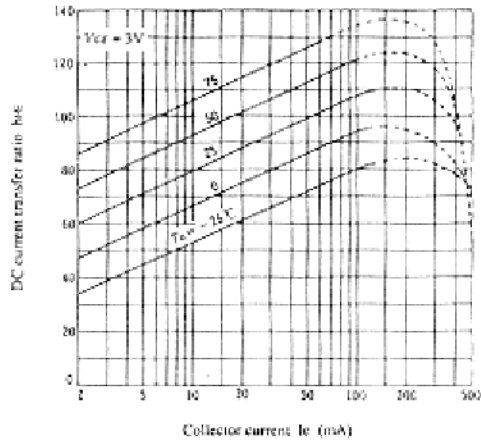

COLLECTOR TO EMITTER SATURATION VOLTAGE VS. COLLECTOR CURRENT

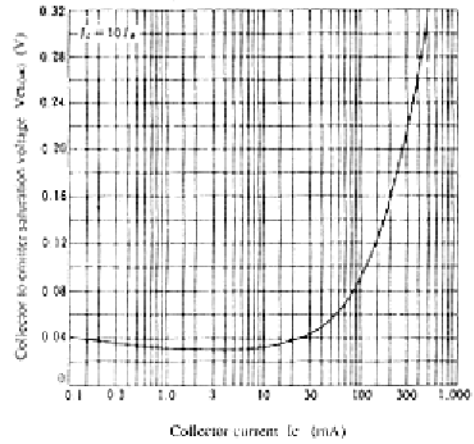

BASE TO EMITTER SATURATION VOLTAGE VS. COLLECTOR CURRENT

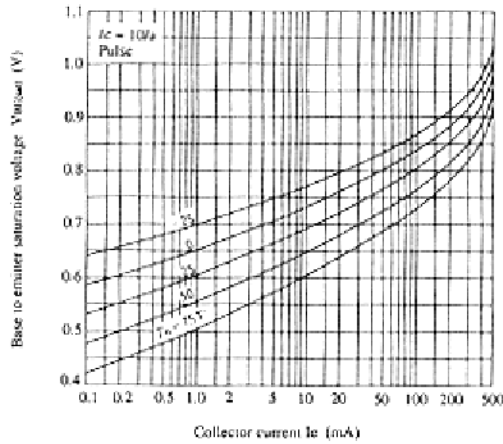

INPUT AND OUTPUT CAPACITANCE VS. VOLTAGE

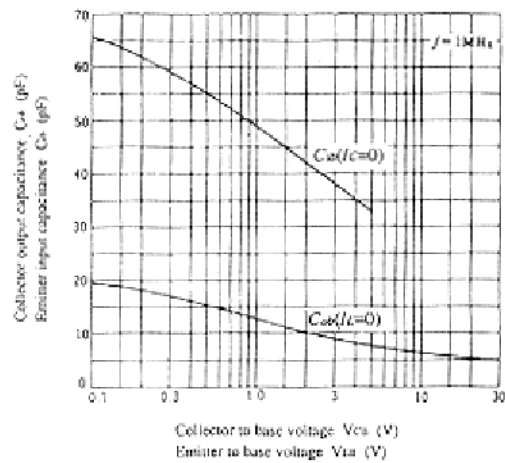

GAIN BANDWIDTH PRODUCT VS. COLLECTOR CURRENT

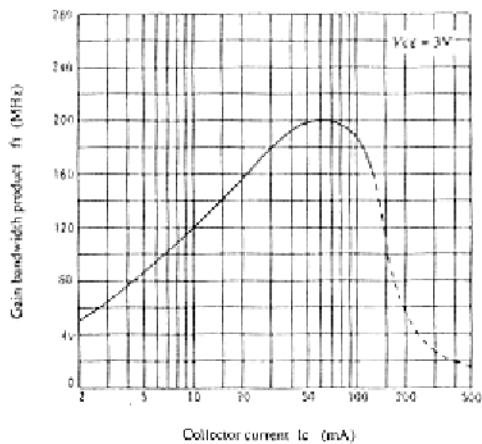

SWITCHING TIME VS. COLLECTOR CURRENT

