



2029A

NPN Epitaxial Planar Silicon Composite Transistor

T-29-27

# Differential Amp Applications

©9768

## Applications

- . Differential amp, current mirror

## Features

- . Excellent in thermal equilibrium and suited for use in differential amp applications.
- . Matched pair capability.

## Absolute Maximum Ratings at Ta=25°C

			unit
Collector to Base Voltage	V <sub>CB0</sub>	130	V
Collector to Emitter Voltage	V <sub>CE0</sub>	120	V
Emitter to Base Current	V <sub>EB0</sub>	5	V
Collector Current	I <sub>C</sub>	50	mA
Peak Collector Current	i <sub>cp</sub>	100	mA
Collector Dissipation	P <sub>C</sub>	200	mW
Total Dissipation	P <sub>T</sub>	400	mW
Junction Temperature	T <sub>J</sub>	150	°C
Storage Temperature	T <sub>stg</sub>	-55 to +150	°C

1 unit

## Electrical Characteristics at Ta=25°C

			min	typ	max	unit
Collector Cutoff Current	I <sub>CB0</sub>	V <sub>CB</sub> =80V, I <sub>E</sub> =0			0.1	uA
Emitter Cutoff Current	I <sub>EB0</sub>	V <sub>EB</sub> =4V, I <sub>C</sub> =0			0.1	uA
DC Current Gain	h <sub>FE</sub>	V <sub>CE</sub> =6V, I <sub>C</sub> =1mA	160*		960*	
DC Current Gain Ratio	h <sub>FE</sub> (small/large)	V <sub>CE</sub> =6V, I <sub>C</sub> =1mA	0.85	0.98		
Base to Emitter Voltage Drop	V <sub>BE</sub> (large-small)	V <sub>CE</sub> =6V, I <sub>C</sub> =1mA	1.0	10		mV
Collector to Emitter Saturation Voltage	V <sub>CE</sub> (sat)	I <sub>C</sub> =10mA, I <sub>B</sub> =1mA			0.5	V
Gain-Bandwidth Product	f <sub>T</sub>	V <sub>CE</sub> =6V, I <sub>C</sub> =1mA		130		MHz
Output Capacitance	c <sub>ob</sub>	V <sub>CB</sub> =10V, f=1MHz		1.6		pF

Continued on next page.

\*:The 2SC3066 is classified by h<sub>FE</sub>(small) as follows:

160 F 320	280 G 560	480 H 960
-----------	-----------	-----------

## Case Outline 2029A (unit:mm)

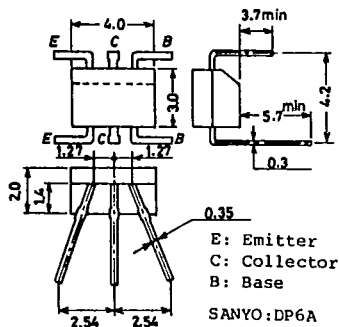

The 2SC3066 is provided with a surface mounted package.

## Case Outline 2030A (unit:mm)

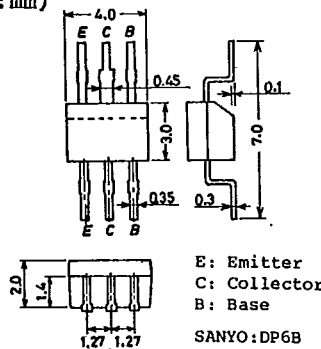

4207KI/2145KI, TS No.976-1/2

T-29-27

Continued from preceding page.

			min	typ	max	unit
Collector to Base Breakdown Voltage	$V_{(BR)CBO}$	$I_C=10\mu A, I_E=0$	130			V
Collector to Emitter Breakdown Voltage	$V_{(BR)CEO}$	$I_C=1mA, R_{BE}=\infty$	120			V
Emitter to Base Breakdown Voltage	$V_{(BR)EBO}$	$I_E=10\mu A, I_C=0$	5			V

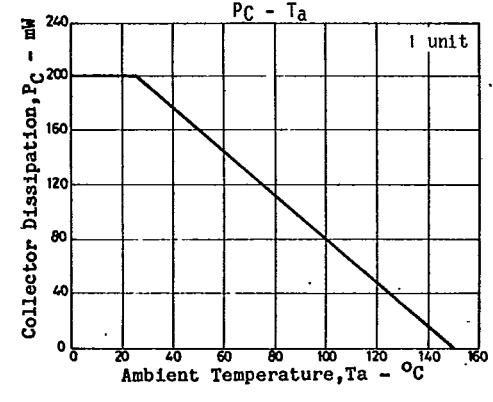
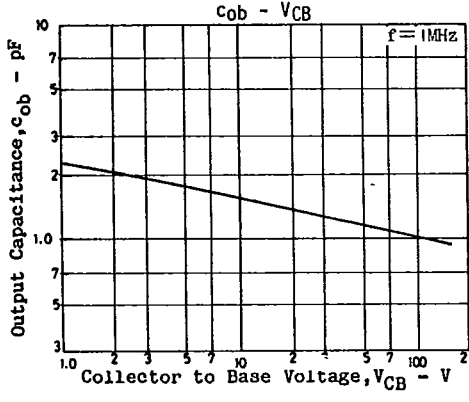
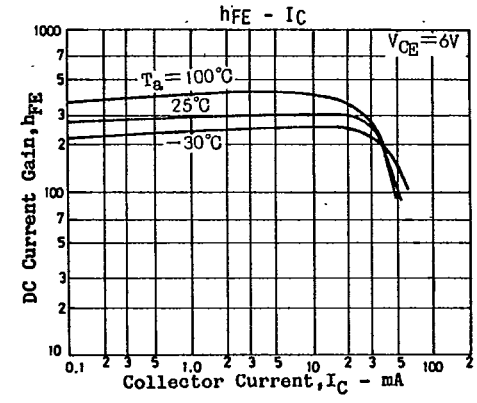
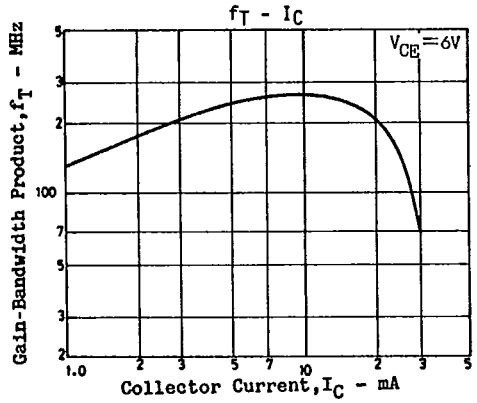
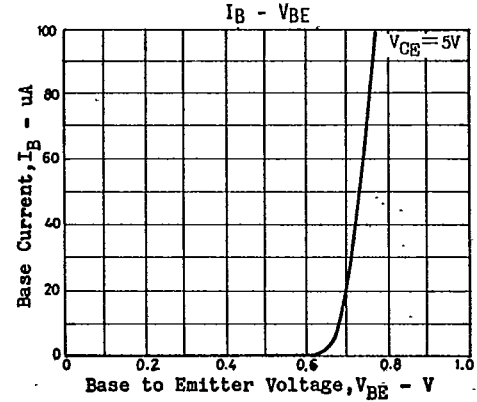
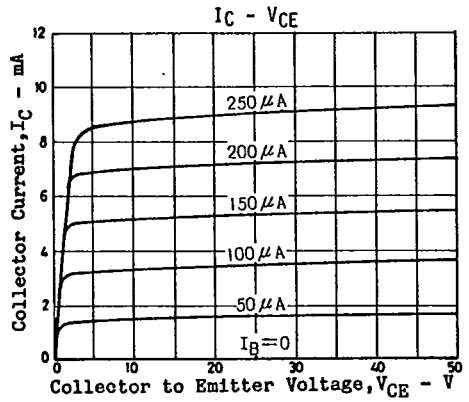

T-91-20

# CASE OUTLINES OF LEAD FORMED SMALL SIGNAL TRANSISTORS

- All of Sanyo lead formed small signal transistor case outlines are illustrated below.
- All dimensions are in mm, and dimensions which are not followed by min. or max. are represented by typical values.
- No marking is indicated.

Case Outline-[2003A] unit: mm

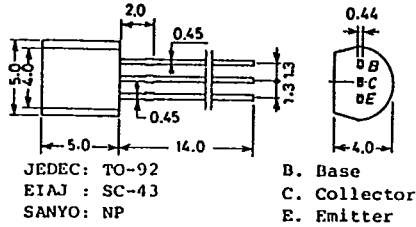

Case Outline-[2019A] unit: mm

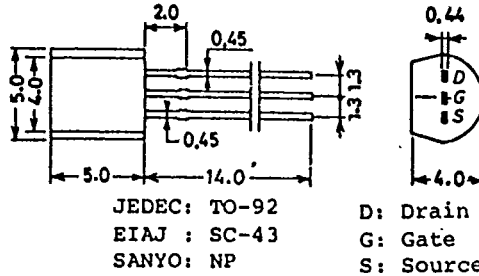

Case Outline-[2004A] unit: mm

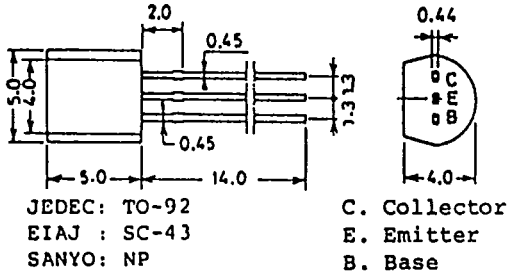

Case Outline-[2025] unit: mm

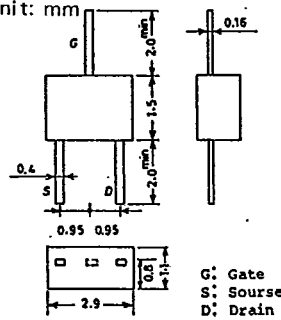

Case Outline-[2005A] unit: mm

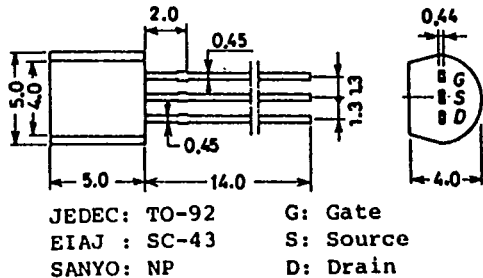

Case Outline-[2026] unit: mm

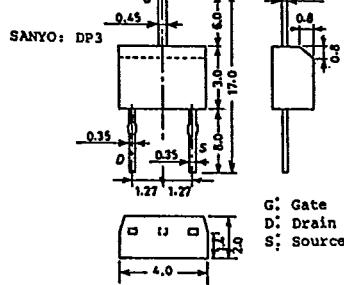

Case Outline-[2006A] unit: mm

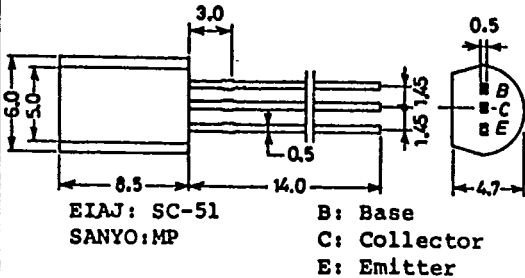

Case Outline-[2027A] unit: mm

