

2SC4980
(TP5S8)

5A NPN

OUTLINE DIMENSIONS

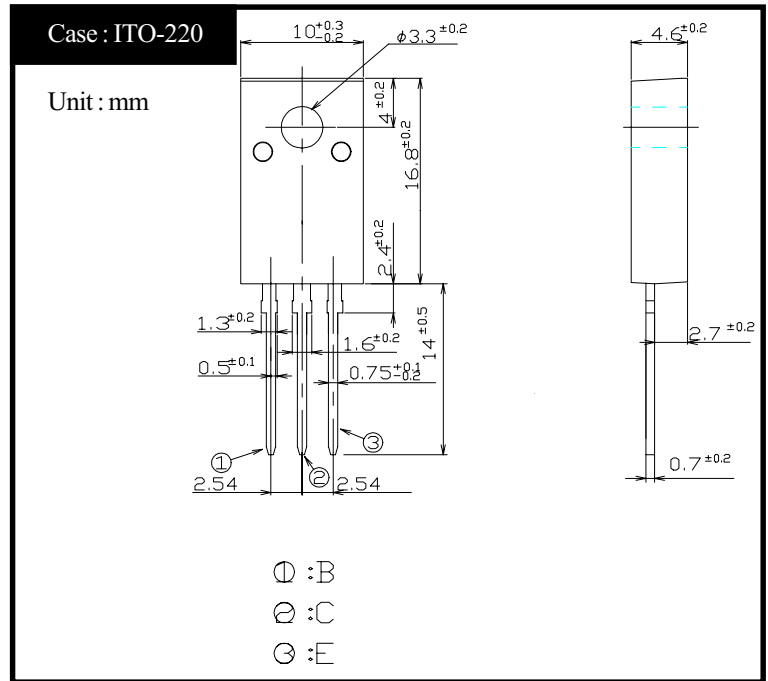

RATINGS

● Absolute Maximum Ratings

Item	Symbol	Conditions	Ratings	Unit
Storage Temperature	T_{stg}		-55 ~ 150	°C
Junction Temperature	T_j		150	°C
Collector to Base Voltage	V_{CBO}		100	V
Collector to Emitter Voltage	V_{CEO}		80	V
Emitter to Base Voltage	V_{EBO}		7	V
Collector Current DC	I_C		5	A
Collector Current Peak	I_{CP}		10	A
Base Current DC	I_B		1.5	A
Base Current Peak	I_{BP}		2	A
Total Transistor Dissipation	P_T	$T_c = 25^\circ\text{C}$	25	W
Dielectric Strength	V_{dis}	Terminal to case, AC 1 minute	2	kV
Mounting Torque	TOR	(Recommended torque : 0.3N·m)	0.5	N·m

● Electrical Characteristics ($T_c=25^\circ\text{C}$)

Item	Symbol	Conditions	Ratings	Unit
Collector to Emitter Sustaining Voltage	$V_{CEO(sus)}$	$I_C = 0.05\text{A}$	Min 80	V
Collector Cutoff Current	I_{CBO}	At rated Voltage	Max 0.1	mA
	I_{CEO}		Max 0.1	
Emitter Cutoff Current	I_{EBO}	At rated Voltage	Max 0.1	mA
DC Current Gain	h_{FE}	$V_{CE} = 2\text{V}, I_C = 2.5\text{A}$	Min 70	
Collector to Emitter Saturation Voltage	$V_{CE(sat)}$	$I_C = 2.5\text{A}$	Max 0.3	V
Base to Emitter Saturation Voltage	$V_{BE(sat)}$	$I_B = 0.13\text{A}$	Max 1.2	V
Thermal Resistance	θ_{jc}	Junction to case	Max 5	°C/W
Transition Frequency	f_T	$V_{CE} = 10\text{V}, I_C = 0.5\text{A}$	TYP 50	MHz
Turn on Time	t_{on}	$I_C = 2.5\text{A}$ $I_{B1} = 0.25\text{A}, I_{B2} = 0.25\text{A}$ $R_L = 12\ \Omega, V_{BB2} = 4\text{V}$	Max 0.3	μs
Storage Time	t_s		Max 1.5	
Fall Time	t_f		Max 0.2	

2SC4980

$h_{FE} - I_C$

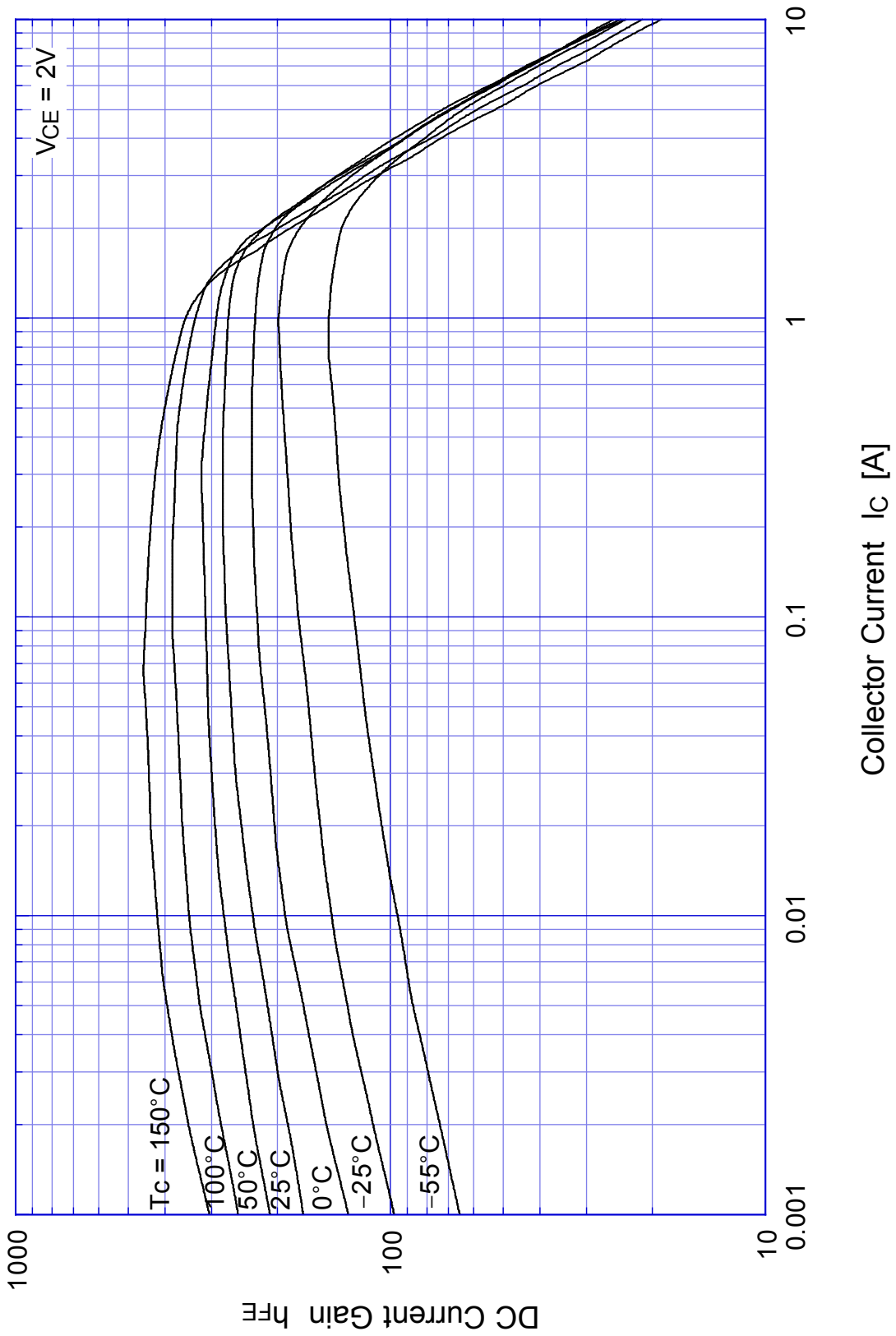

2SC4980 Saturation Voltage

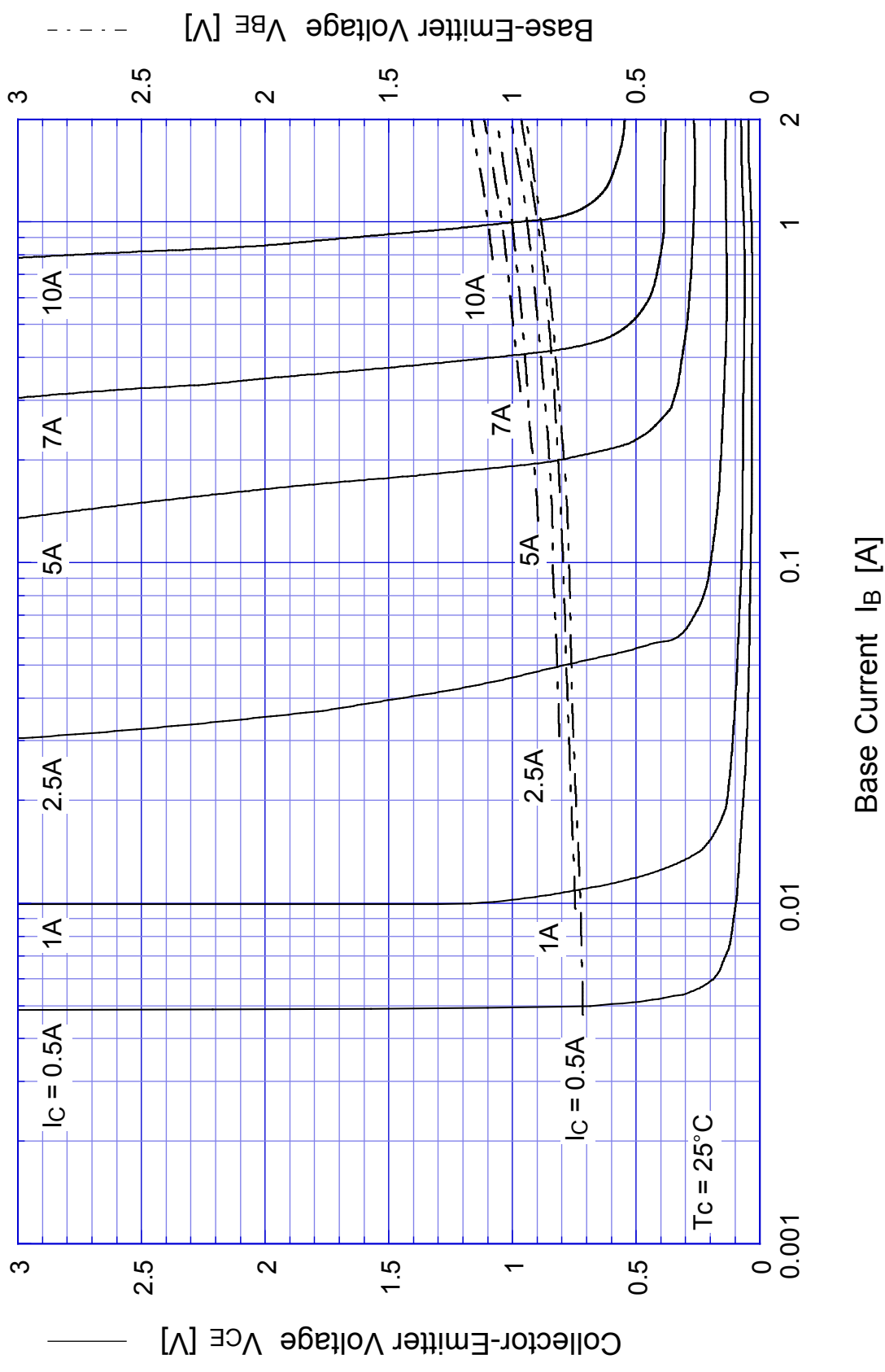

2SC4980

Switching Time - I_C

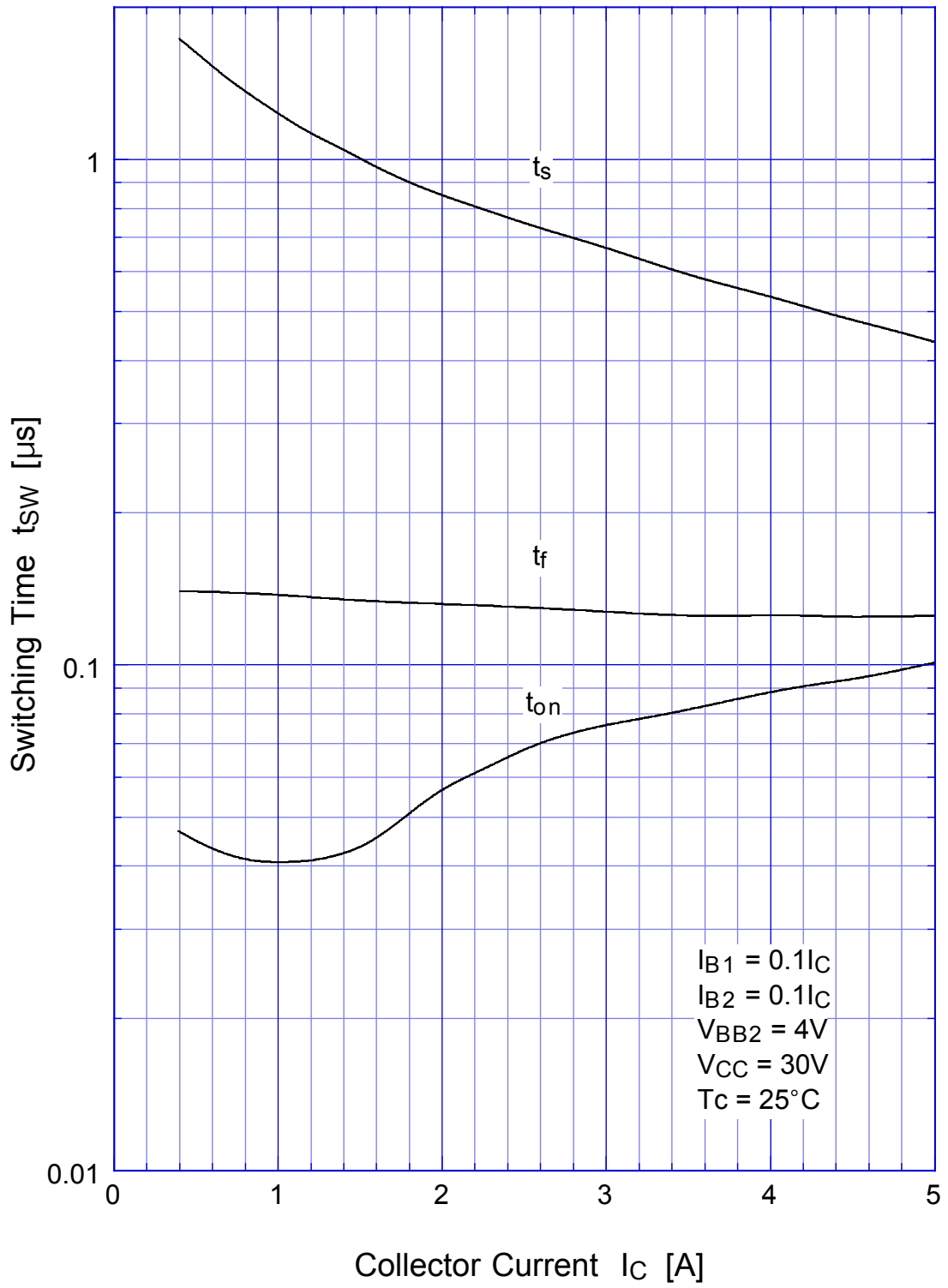

2SC4980

Switching Time - Tc

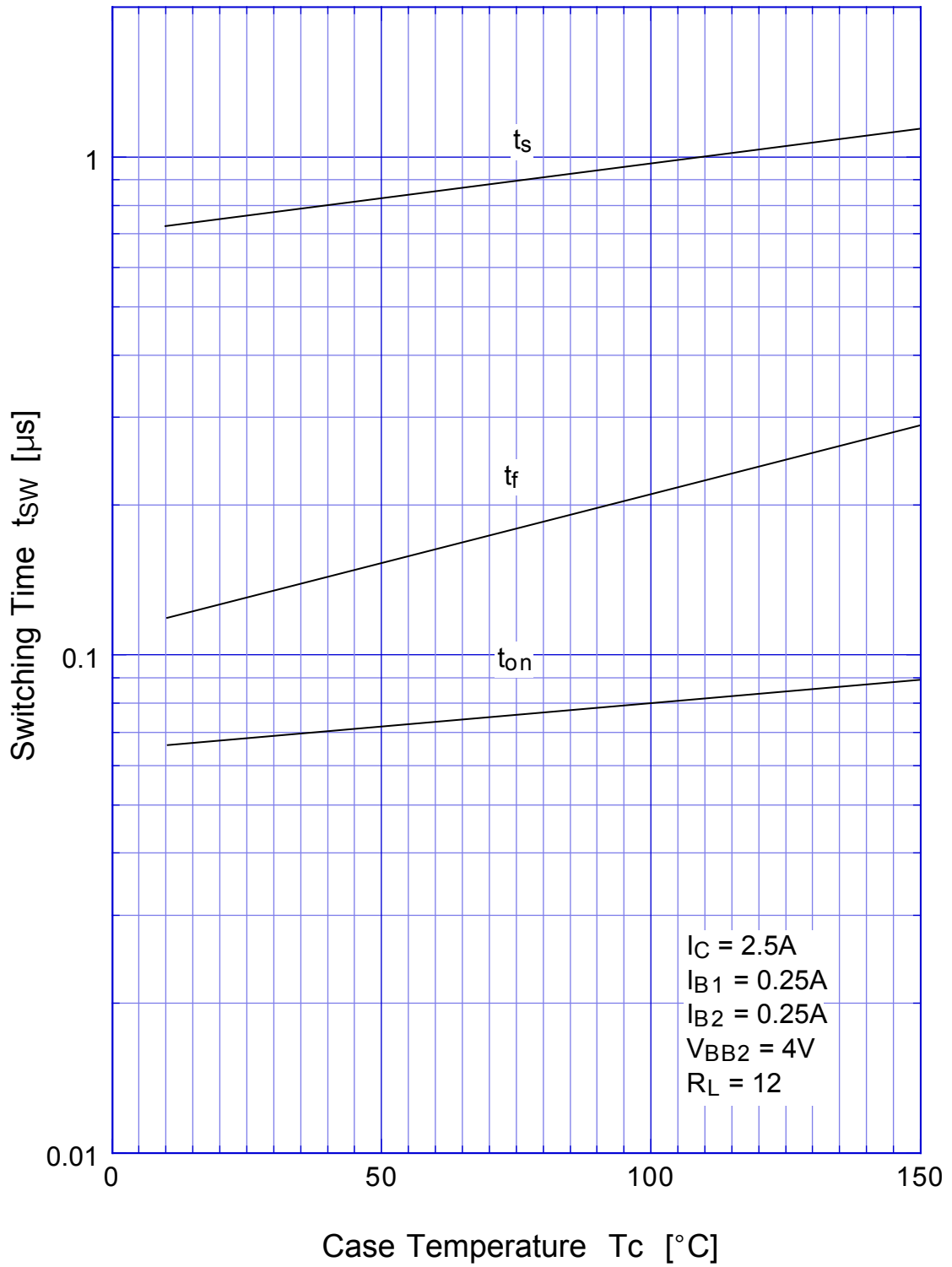

2SC4980 Transient Thermal Impedance

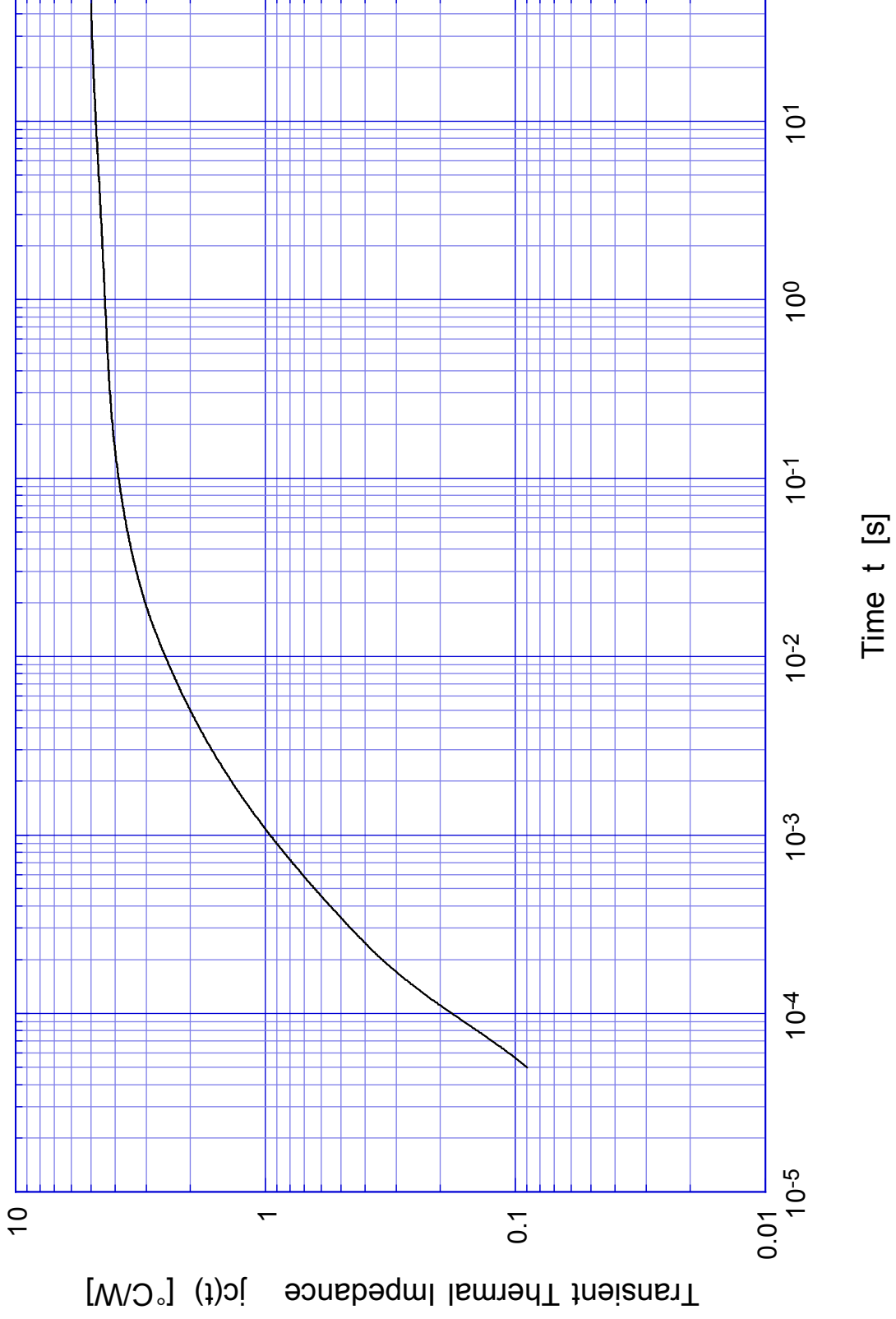

2SC4980

Forward Bias SOA

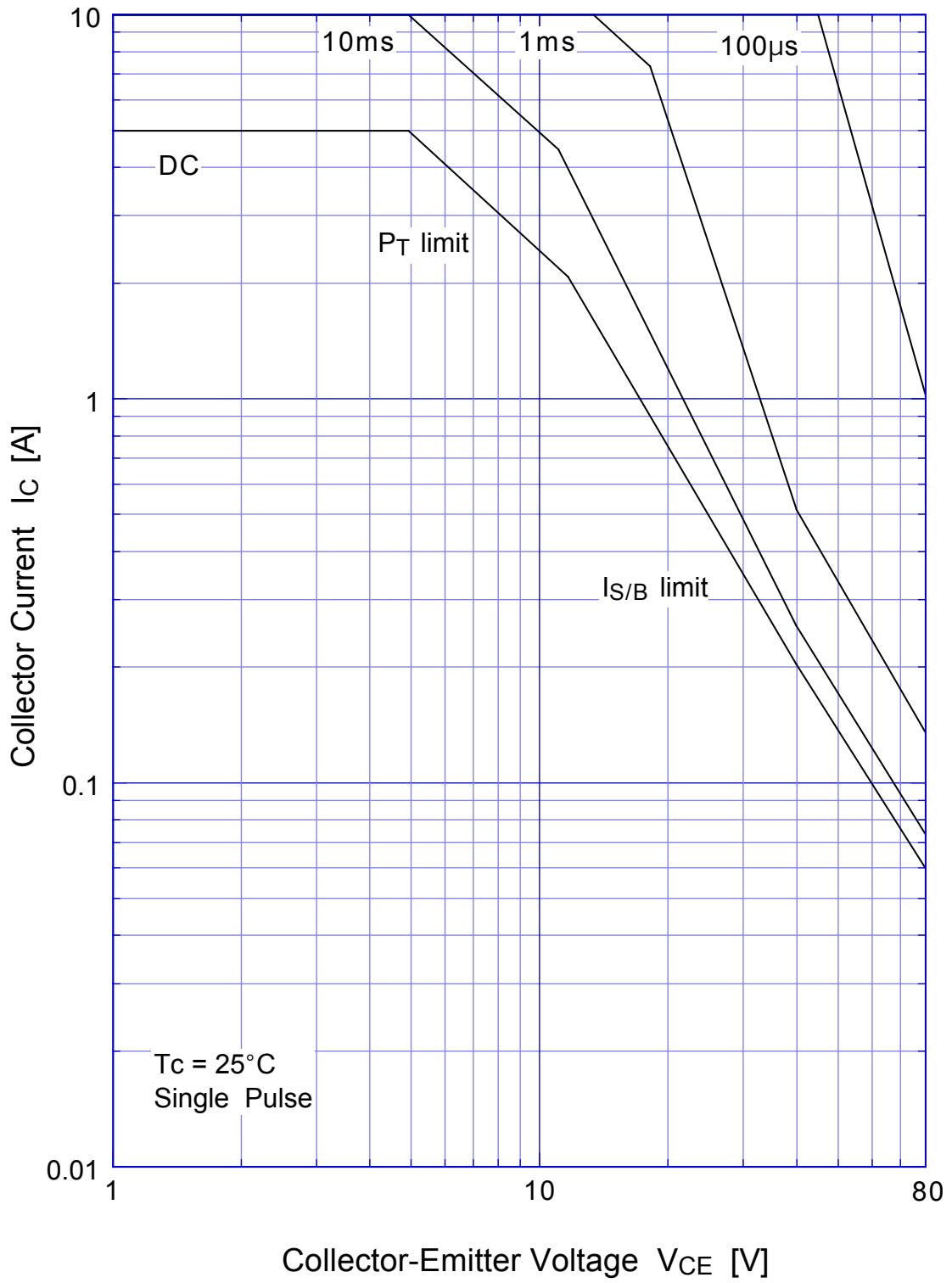

2SC4980 Collector Current Derating

