

SHINDENGEN

Darlington Transistor

2SD1790
(TP4L6Z)

± 4A NPN

OUTLINE DIMENSIONS

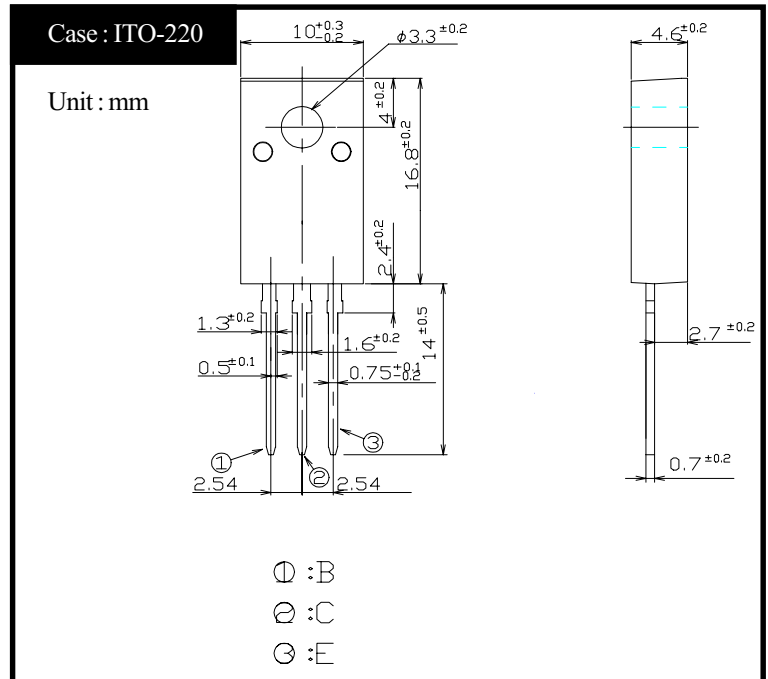

RATINGS

● Absolute Maximum Ratings

Item	Symbol	Conditions	Ratings	Unit
Storage Temperature	T_{stg}		-55~+150	°C
Junction Temperature	T_j		+150	°C
Collector to Base Voltage	V_{CBO}		60 ^{±10}	V
Collector to Emitter Voltage	V_{CEO}		60 ^{±10}	V
Emitter to Base Voltage	V_{EBO}		7	V
Collector Current DC	I_C		±4	A
Collector Current Peak	I_{CP}		±6	A
Base Current DC	I_B		0.3	A
Base Current Peak	I_{BP}		0.5	A
Total Transistor Dissipation	P_T	$T_c = 25^\circ\text{C}$	25	W
Dielectric Strength	V_{dis}	Terminals to case AC 1 minute	2	kV
Mounting Torque	TOR	(Recommended torque : 0.3N·m)	0.5	N·m

● Electrical Characteristics ($T_c=25^\circ\text{C}$)

Item	Symbol	Conditions	Ratings	Unit
Collector Cutoff Current	I_{CBO}	$V_{CB} = 40\text{V}$	Max 0.1	mA
	I_{CEO}	$V_{CE} = 40\text{V}$	Max 0.1	
Emitter Cutoff Current	I_{EBO}	$V_{EB} = 7\text{V}$	Max 5	mA
DC Current Gain	h_{FE}	$V_{CE} = 3\text{V}, I_C = 1\text{A}$	Min 1,500	
			Max 30,000	
Collector to Emitter Saturation Voltage	$V_{CE(sat)}$	$I_C = 1\text{A}$	Max 1.5	V
Base to Emitter Saturation Voltage	$V_{BE(sat)}$	$I_B = 2\text{mA}$	Max 2.0	V
Thermal Resistance	θ_{jc}	Junction to case	Max 5.0	°C/W
Transition Frequency	f_T	$V_{CE} = 10\text{V}, I_C = 0.4\text{A}$	TYP 20	MHz
Turn on Time	t_{on}		Max 2	μs
Storage Time	t_s	$I_C = 1\text{A}$ $I_{B1} = I_{B2} = 2\text{mA}$ $R_L = 25\ \Omega$	Max 12	
Fall Time	t_f	$V_{BB2} = 4\text{V}$	Max 5	

2SD1790

$h_{FE} - I_C$

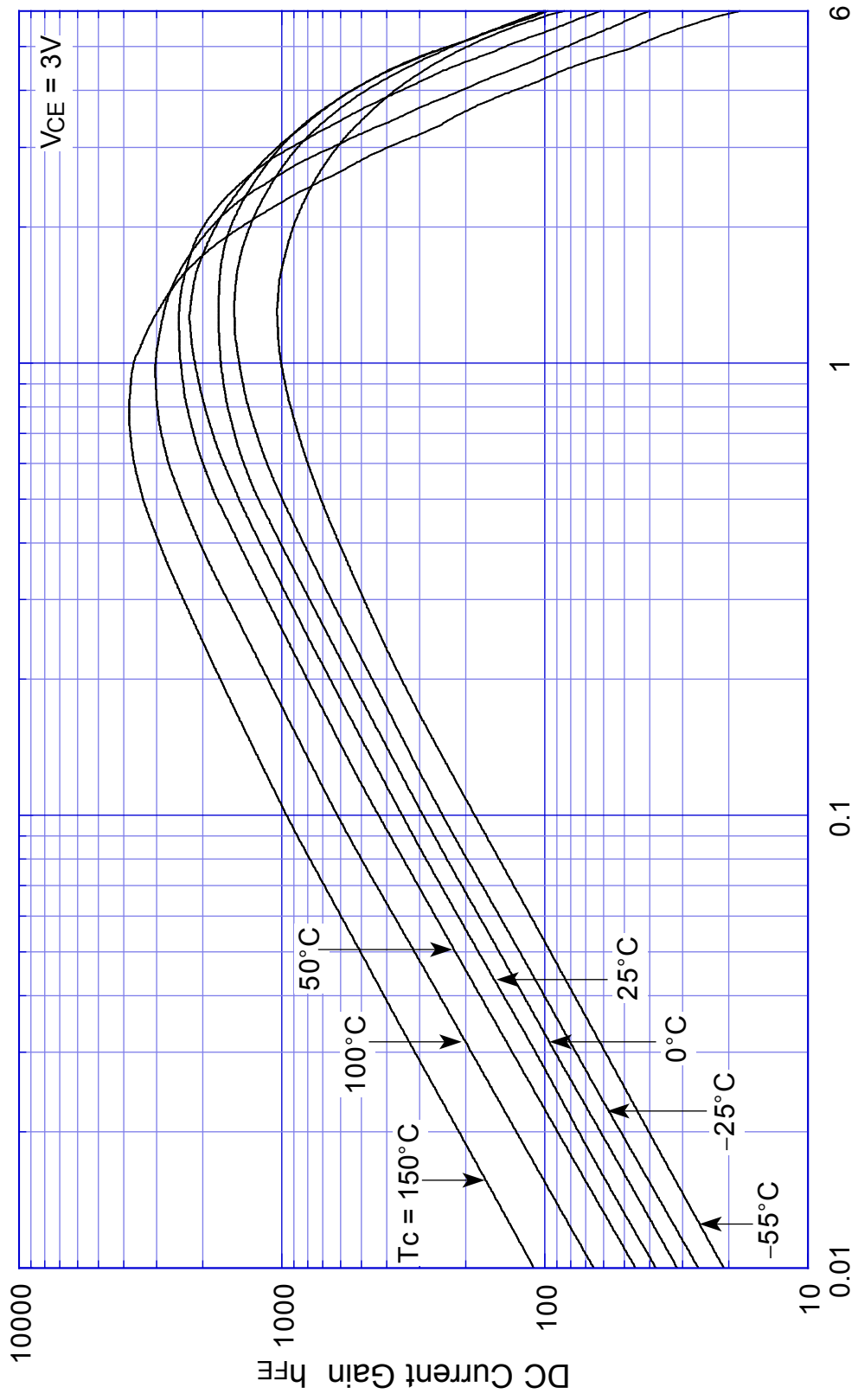

Collector Current I_C [A]

2SD1790 Saturation Voltage

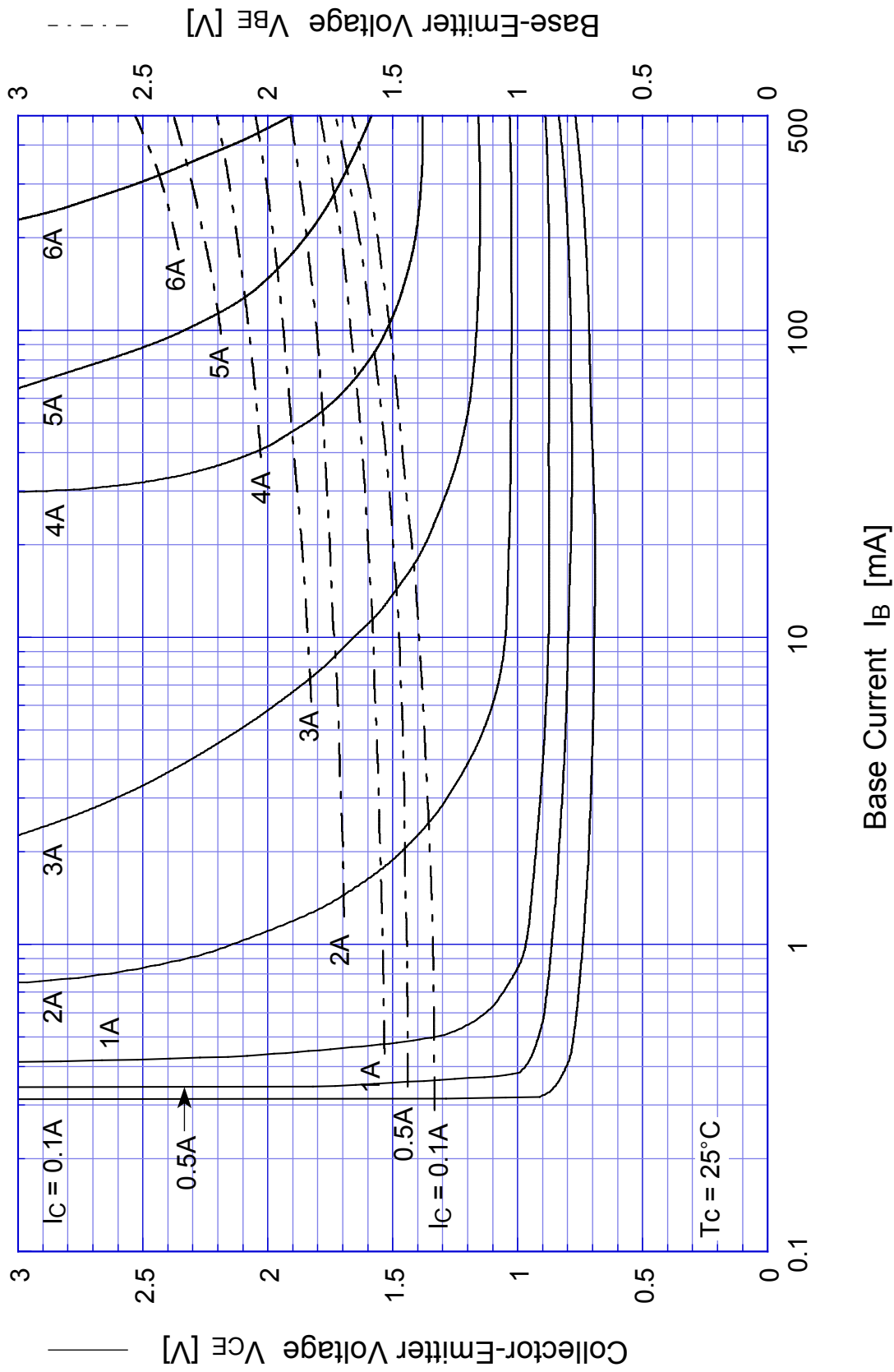

2SD1790

Switching Time - I_C

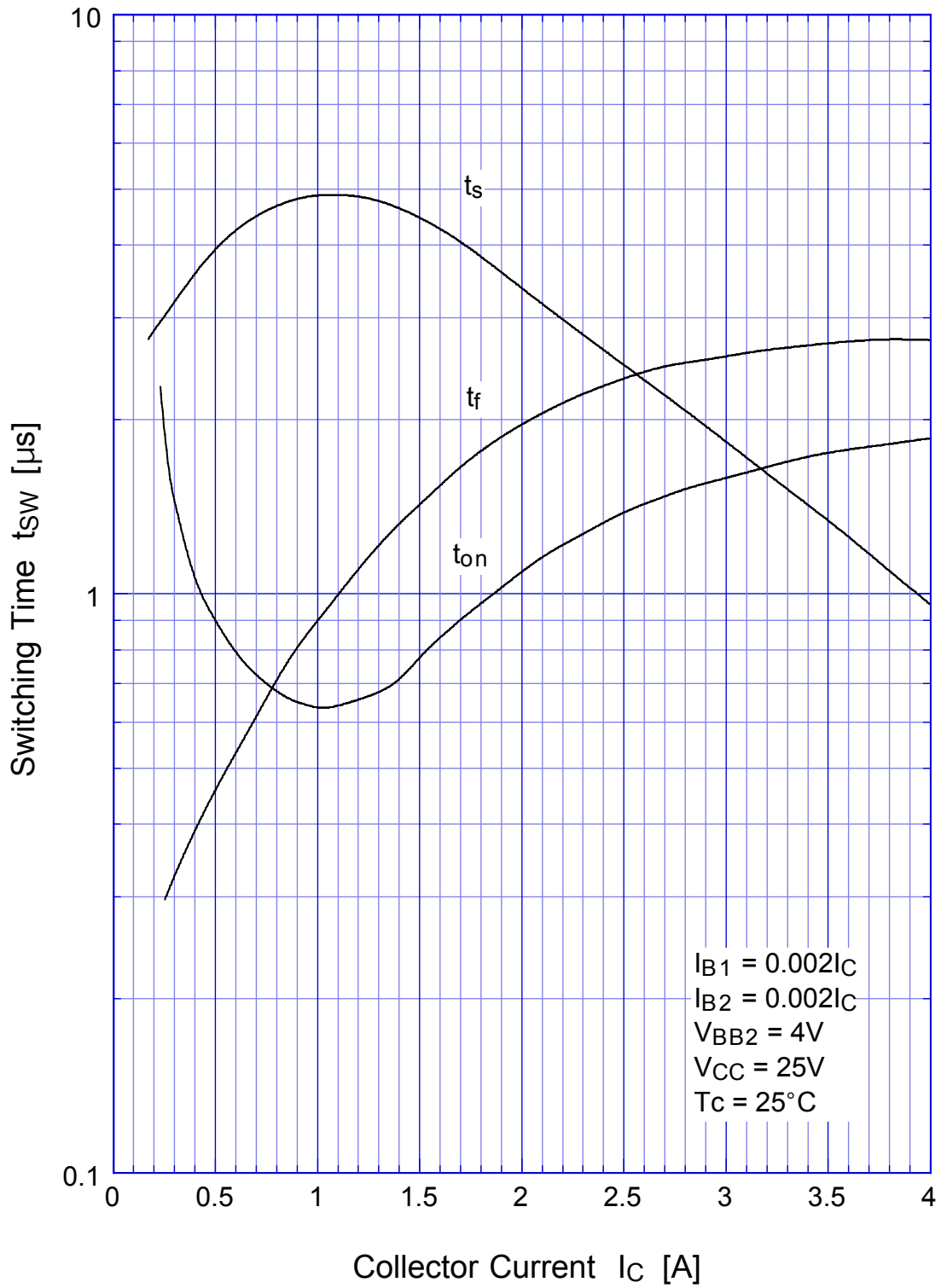

2SD1790

Switching Time - Tc

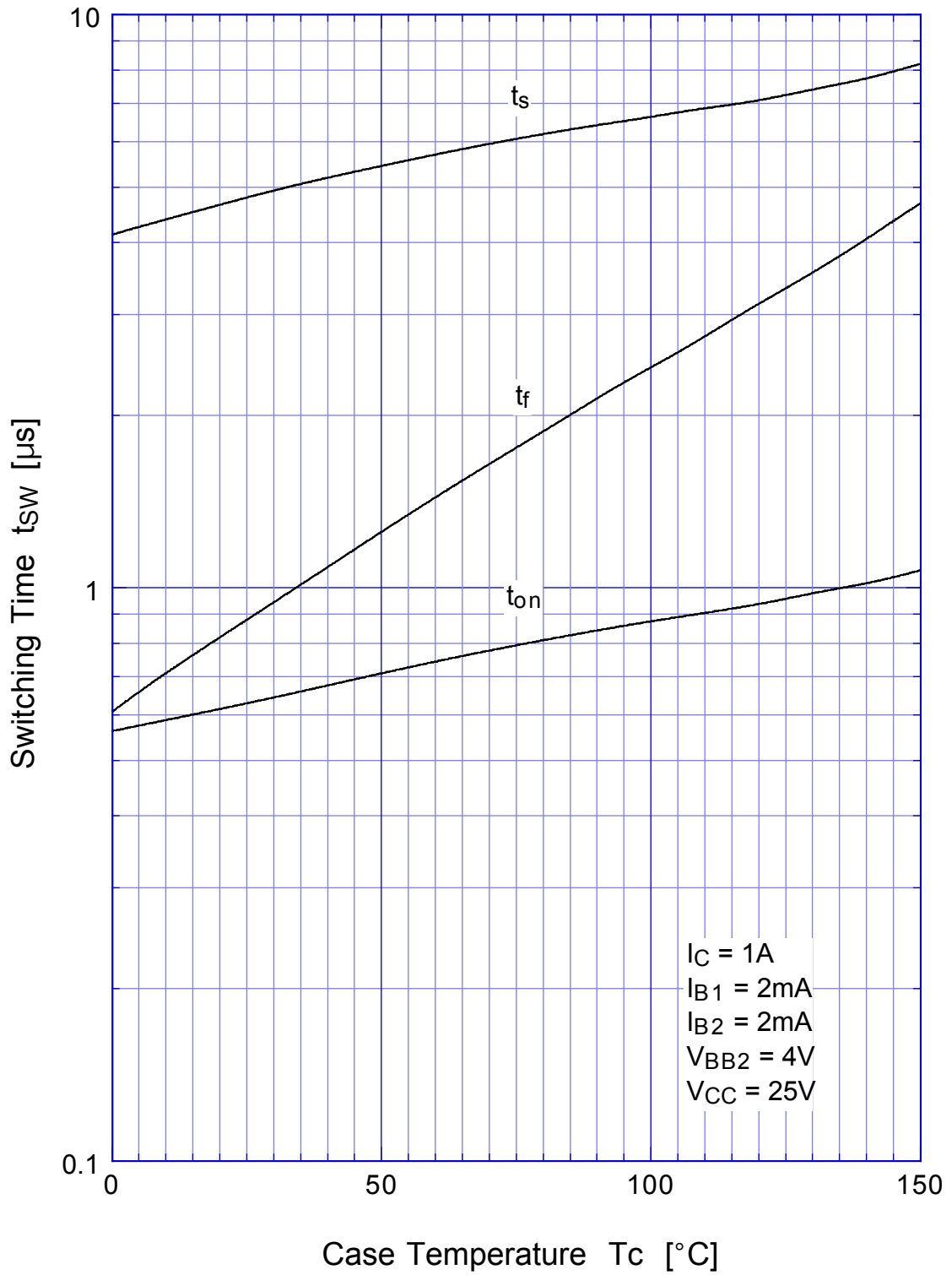

2SD1790 Transient Thermal Impedance

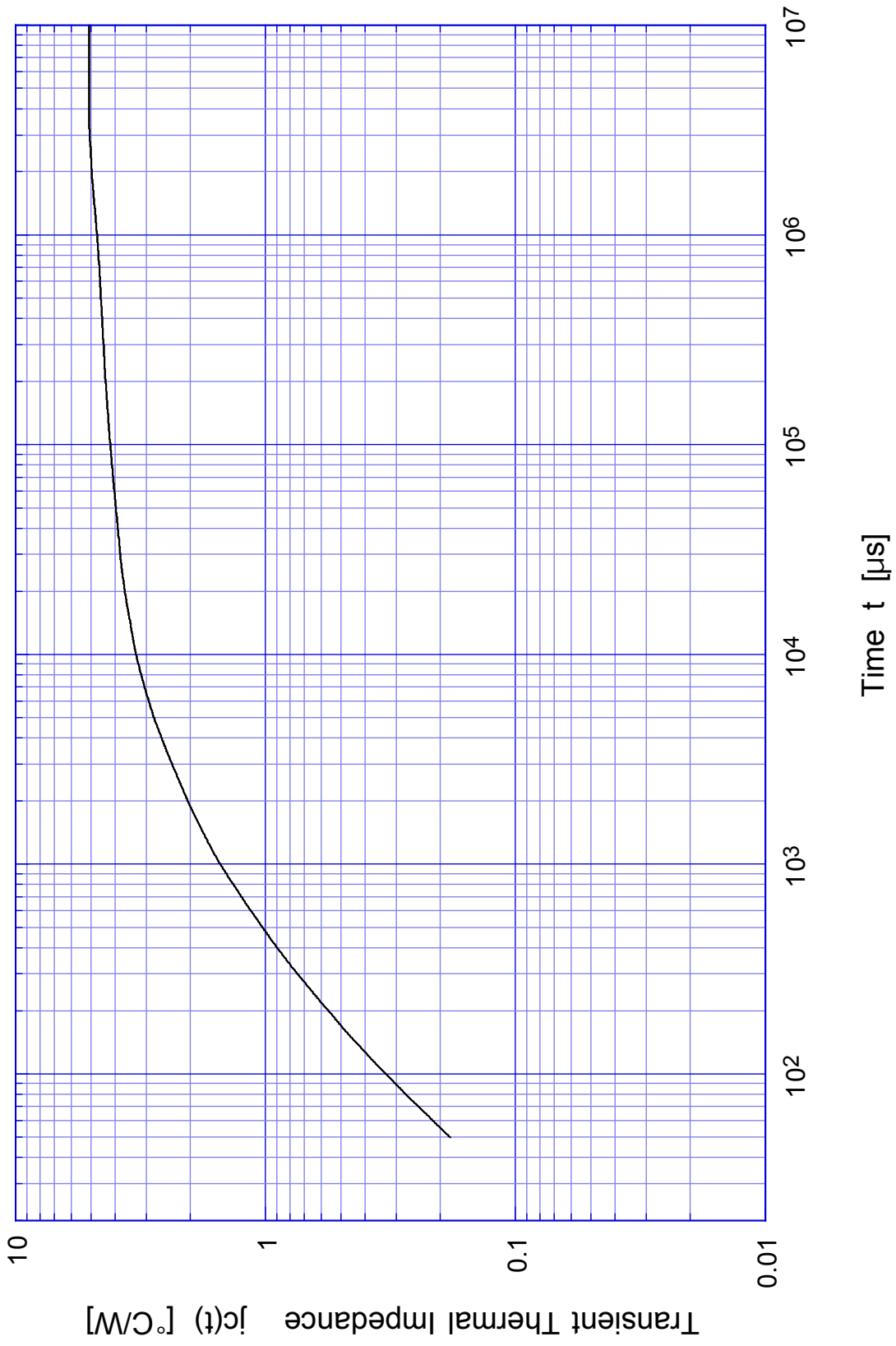

2SD1790 Collector Current Derating

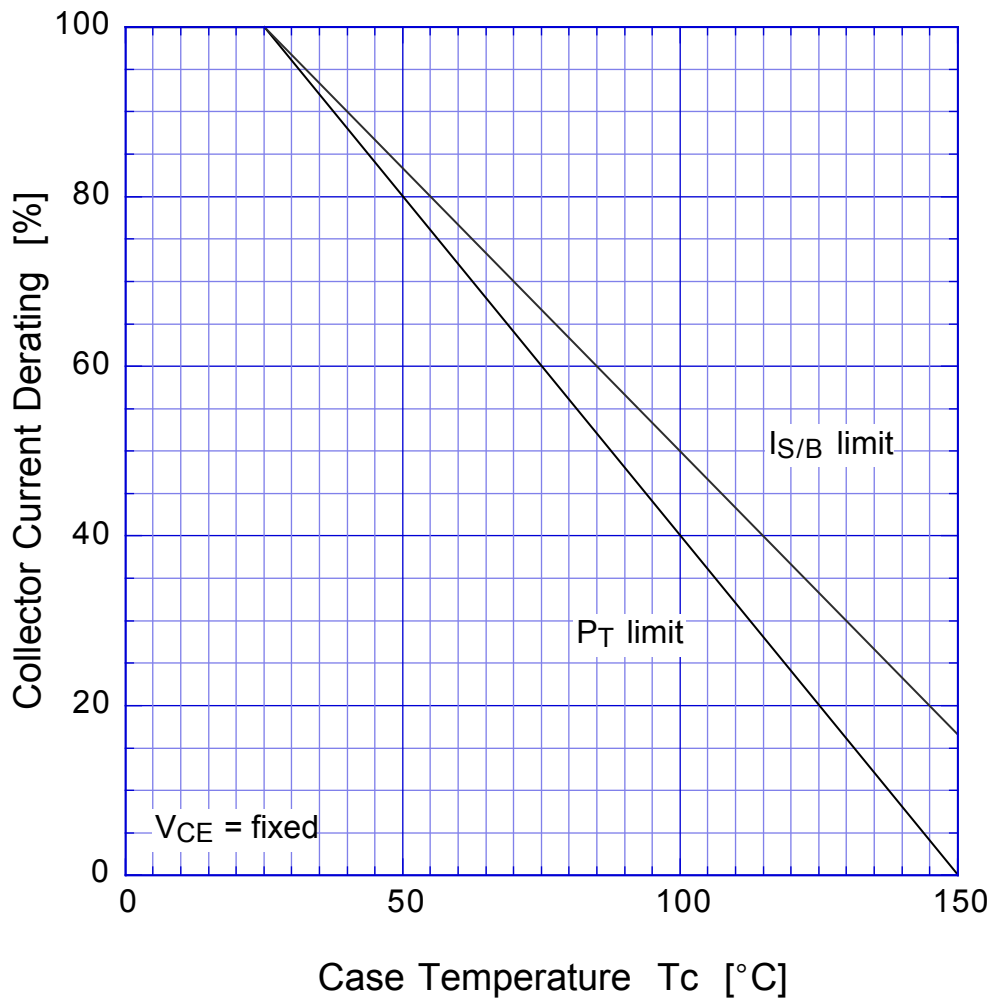

2SD1790

$V_{EC} - I_C$

