

2SJ217

SILICON P-CHANNEL MOS FET

HIGH SPEED POWER SWITCHING

FEATURES

- Low On-Resistance
- High Speed Switching
- Low Drive Current
- 4 V Gate Drive Device
 - Can be driven from 5V source
- Suitable for Motor Drive, DC-DC Converter, Power Switch and Solenoid Drive

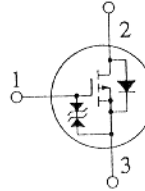

1. Gate
2. Drain (Flange)
3. Source
(Dimensions in mm)

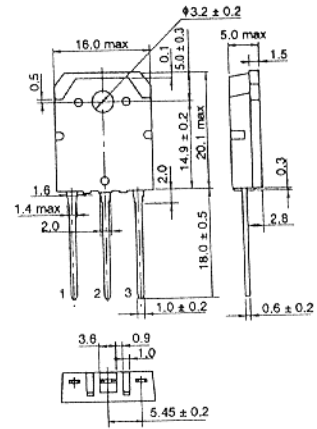

(TO-3P)

ABSOLUTE MAXIMUM RATINGS (Ta = 25°C)

Item	Symbol	Rating	Unit
Drain-Source Voltage	V_{DSS}	-60	V
Gate-Source Voltage	V_{GSS}	±20	V
Drain Current	I_D	-45	A
Drain Peak Current	$I_D(pulse)^*$	-180	A
Body-Drain Diode	I_{DR}	-45	A
Reverse Drain Current			
Channel Dissipation	P_{ch}^{**}	150	W
Channel Temperature	T_{ch}	150	°C
Storage Temperature	T_{stg}	-55 ~ +150	°C

* $PW \leq 10 \mu s$, duty cycle $\leq 1\%$

** Value at $T_c = 25^\circ C$

POWER VS. TEMPERATURE DERATING

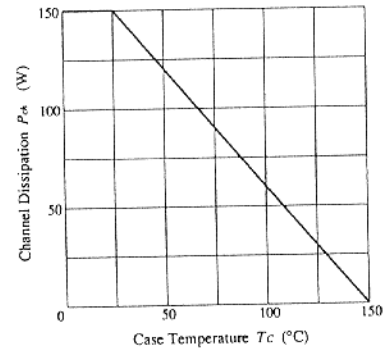

ELECTRICAL CHARACTERISTICS (Ta = 25°C)

Item	Symbol	Test Condition	min.	typ.	max.	Unit
Drain-Source Breakdown Voltage	$V_{(BR)DSS}$	$I_D = -10mA, V_{GS} = 0$	-60	—	—	V
Gate-Source Breakdown Voltage	$V_{(BR)GSS}$	$I_G = \pm 100 \mu A, V_{DS} = 0$	±20	—	—	V
Gate-Source Leak Current	I_{GSS}	$V_{GS} = \pm 16V, V_{DS} = 0$	—	—	±10	μA
Zero Gate Voltage Drain Current	I_{DSS}	$V_{DS} = -50V, V_{GS} = 0$	—	—	-250	μA
Gate-Source Cutoff Voltage	$V_{GS(off)}$	$I_D = -1mA, V_{DS} = -10V$	-1.0	—	-2.0	V
Static Drain-Source on State Resistance	$R_{DS(on)}$	$I_D = -20A, V_{GS} = -10V^*$	—	0.033	0.042	Ω
		$I_D = -20A, V_{GS} = -4V^*$	—	0.045	0.06	
Forward Transfer Admittance	$ y_{f1} $	$I_D = -20A, V_{DS} = -10V^*$	16	25	—	S
Input Capacitance	C_{iss}	$V_{DS} = -10V, V_{GS} = 0$	—	3800	—	pF
Output Capacitance	C_{oss}	$f = 1MHz$	—	2000	—	pF
Reverse Transfer Capacitance	C_{rss}		—	490	—	pF
Turn-On Delay Time	$t_{d(on)}$		—	30	—	ns
Rise Time	t_r	$I_D = -20A, V_{GS} = -10V, R_L = 1.5 \Omega$	—	235	—	ns
Turn-Off Delay Time	$t_{d(off)}$		—	670	—	ns
Fall Time	t_f		—	450	—	ns
Body-Drain Diode Forward Voltage	V_{DF}	$I_F = -45A, V_{GS} = 0$	—	-1.35	—	V
Body-Drain Diode Reverse Recovery Time	t_r	$I_F = -45A, V_{GS} = 0, di_F/dt = 50A/\mu s$	—	300	—	ns

* Pulse Test

MAXIMUM SAFE OPERATION AREA

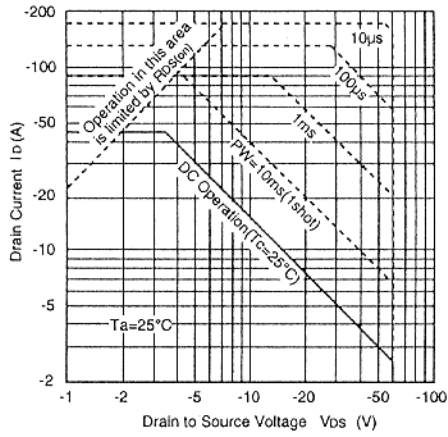

TYPICAL OUTPUT CHARACTERISTICS

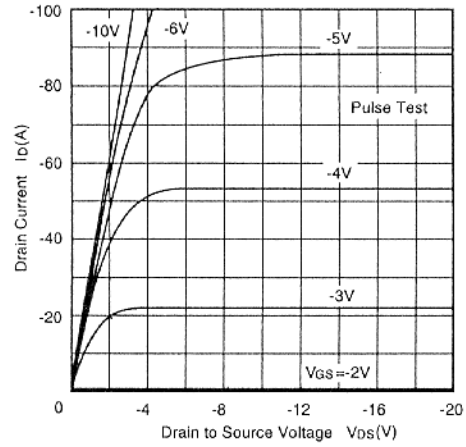

TYPICAL FORWARD TRANSFER CHARACTERISTICS

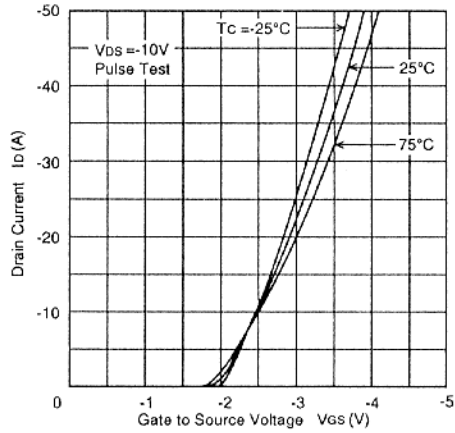

DRAIN TO SOURCE SATURATION VOLTAGE VS. GATE TO SOURCE VOLTAGE

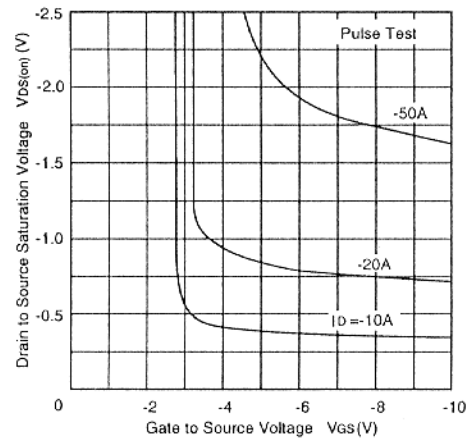

STATIC DRAIN TO SOURCE ON STATE RESISTANCE VS. DRAIN CURRENT

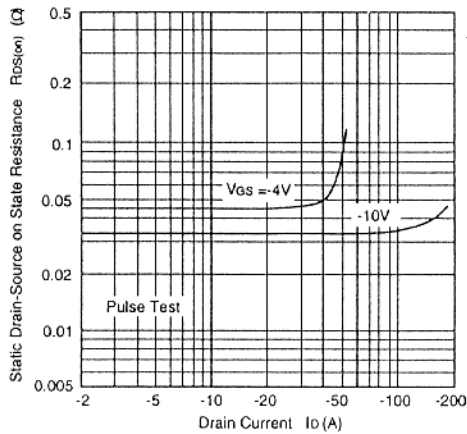

STATIC DRAIN TO SOURCE ON STATE RESISTANCE VS. TEMPERATURE

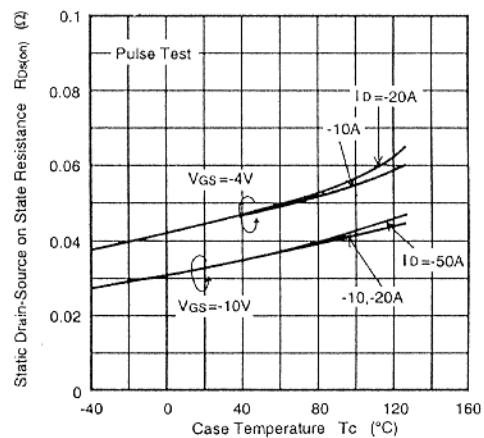

FORWARD TRANSFER ADMITTANCE VS. DRAIN CURRENT

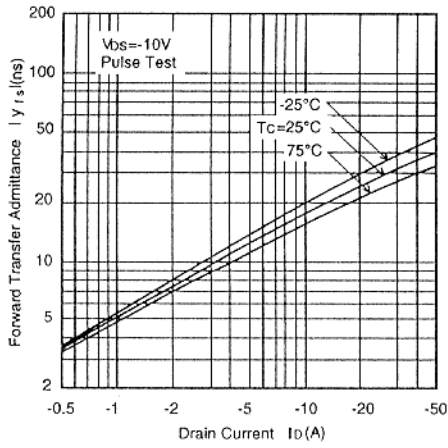

BODY - DRAIN DIODE REVERSE RECOVERY TIME

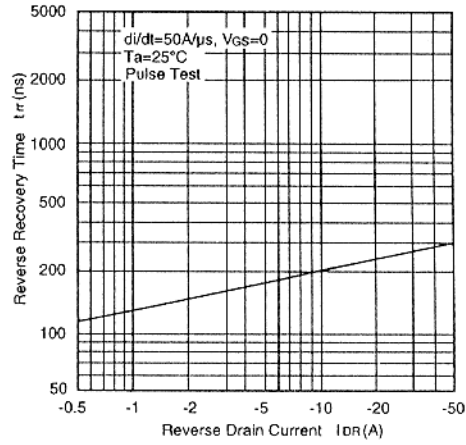

TYPICAL CAPACITANCE VS. DRAIN TO SOURCE VOLTAGE

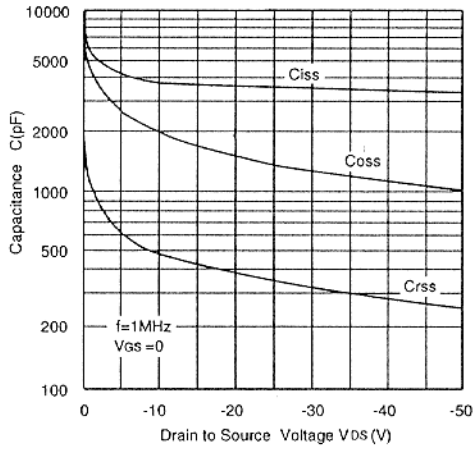

DYNAMIC INPUT CHARACTERISTICS

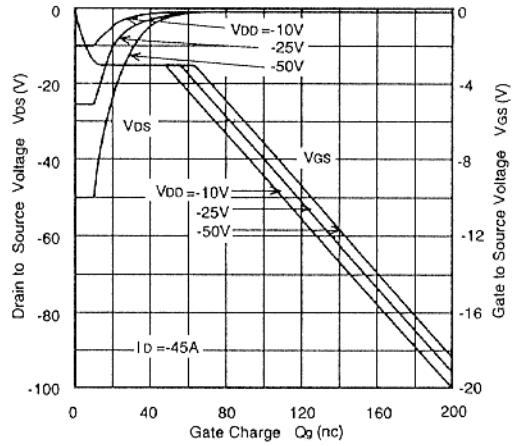

SWITCHING CHARACTERISTICS

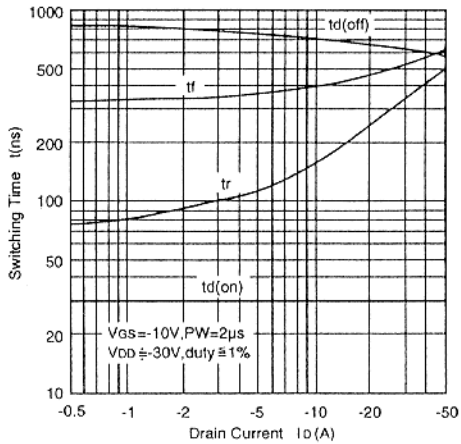

REVERSE DRAIN CURRENT VS. SOURCE TO DRAIN VOLTAGE

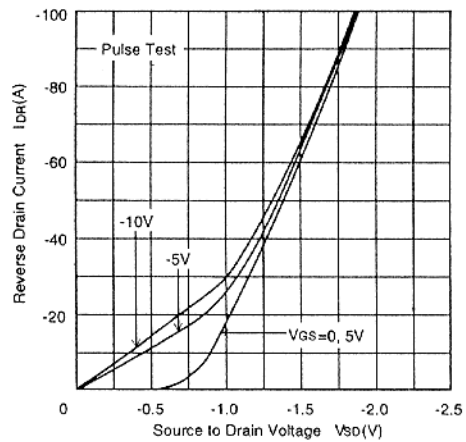

NORMALIZED TRANSIENT THERMAL IMPEDANCE VS. PULSE WIDTH

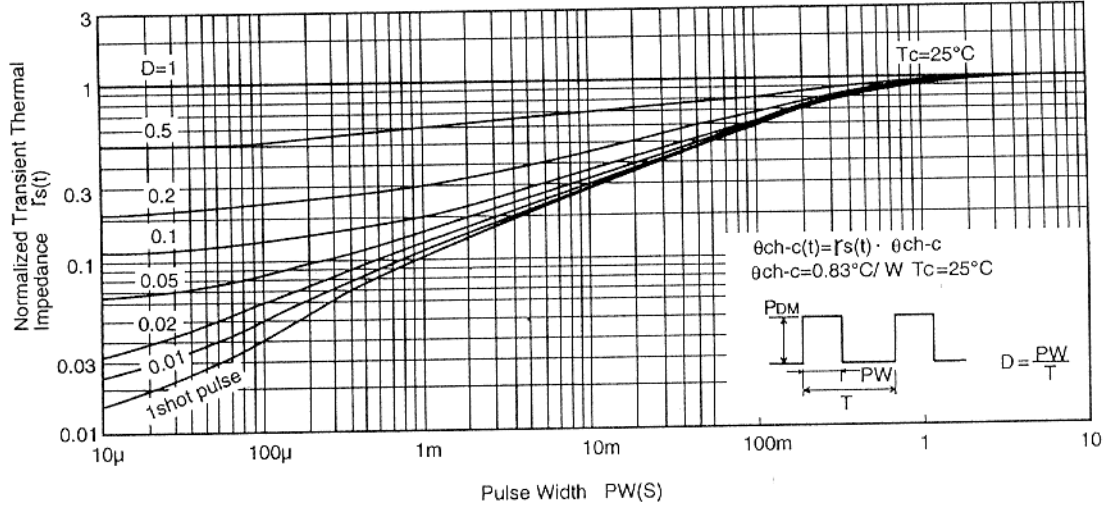

SWITCHING TIME TEST CIRCUIT

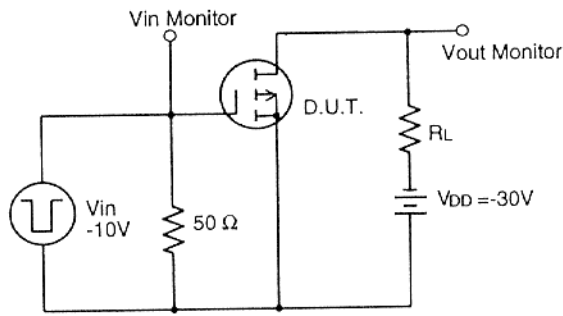

SWITCHING TIME TEST WAVEFORMS

