

## 2SK2007

### Silicon N Channel MOS FET

#### Application

High speed power switching

#### Features

- Low on-resistance
- High speed switching
- Low drive current
- No Secondary Breakdown
- Suitable for Switching regulator, DC – DC converter, Motor Control

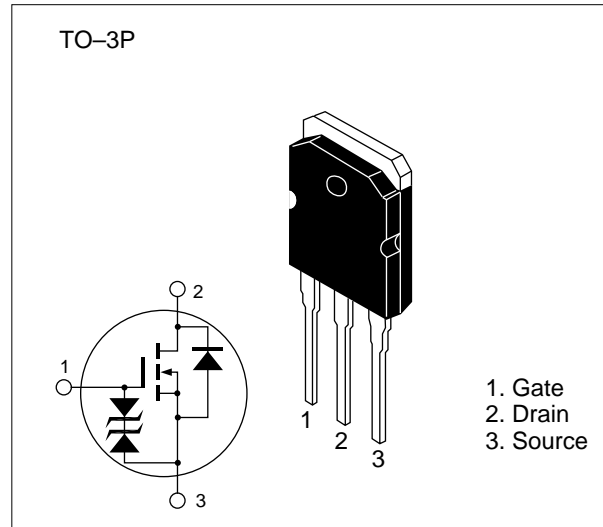

**Table 1 Absolute Maximum Ratings** ( $T_a = 25^\circ\text{C}$ )

Item	Symbol	Ratings	Unit
Drain to source voltage	$V_{DSS}$	250	V
Gate to source voltage	$V_{GSS}$	$\pm 30$	V
Drain current	$I_D$	20	A
Drain peak current	$I_{D(\text{pulse})}^*$	80	A
Body-drain diode reverse drain current	$I_{DR}$	20	A
Channel dissipation	$P_{ch}^{**}$	100	W
Channel temperature	$T_{ch}$	150	$^\circ\text{C}$
Storage temperature	$T_{stg}$	-55 to +150	$^\circ\text{C}$

\*  $PW \leq 10 \mu\text{s}$ , duty cycle  $\leq 1\%$

\*\* Value at  $T_c = 25^\circ\text{C}$

**Table 2 Electrical Characteristics** (Ta = 25°C)

Item	Symbol	Min	Typ	Max	Unit	Test conditions
Drain to source breakdown voltage	$V_{(BR)DSS}$	250	—	—	V	$I_D = 10 \text{ mA}, V_{GS} = 0$
Gate to source breakdown voltage	$V_{(BR)GSS}$	±30	—	—	V	$I_G = \pm 100 \text{ } \mu\text{A}, V_{DS} = 0$
Gate to source leak current	$I_{GSS}$	—	—	±10	μA	$V_{GS} = \pm 25 \text{ V}, V_{DS} = 0$
Zero gate voltage drain current	$I_{DSS}$	—	—	250	μA	$V_{DS} = 200 \text{ V}, V_{GS} = 0$
Gate to source cutoff voltage	$V_{GS(off)}$	2.0	—	3.0	V	$I_D = 1 \text{ mA}, V_{DS} = 10 \text{ V}$
Static drain to source on state resistance	$R_{DS(on)}$	—	0.12	0.15	Ω	$I_D = 10 \text{ A}$ $V_{GS} = 10 \text{ V}^*$
Forward transfer admittance	$ y_{fs} $	9.0	14	—	S	$I_D = 10 \text{ A}$ $V_{DS} = 10 \text{ V}^*$
Input capacitance	$C_{iss}$	—	2340	—	pF	$V_{DS} = 10 \text{ V}$
Output capacitance	$C_{oss}$	—	1000	—	pF	$V_{GS} = 0$
Reverse transfer capacitance	$C_{rss}$	—	160	—	pF	$f = 1 \text{ MHz}$
Turn-on delay time	$t_{d(on)}$	—	30	—	ns	$I_D = 10 \text{ A}$
Rise time	$t_r$	—	125	—	ns	$V_{GS} = 10 \text{ V}$
Turn-off delay time	$t_{d(off)}$	—	190	—	ns	$R_L = 3 \text{ } \Omega$
Fall time	$t_f$	—	100	—	ns	
Body-drain diode forward voltage	$V_{DF}$	—	1.2	—	V	$I_F = 20 \text{ A}, V_{GS} = 0$
Body-drain diode reverse recovery time	$t_{rr}$	—	120	—	ns	$I_F = 20 \text{ A}, V_{GS} = 0,$ $di_F / dt = 100 \text{ A} / \mu\text{s}$

\* Pulse Test

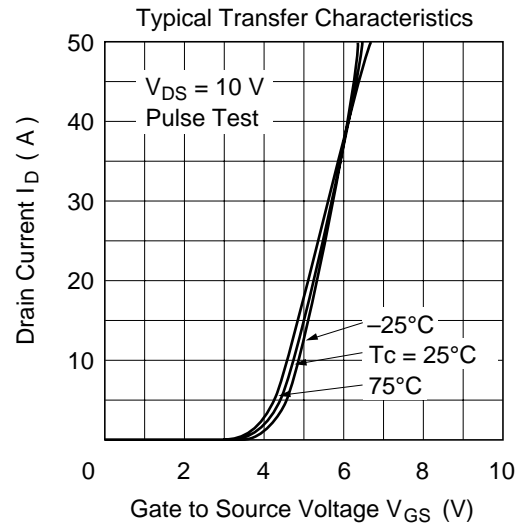
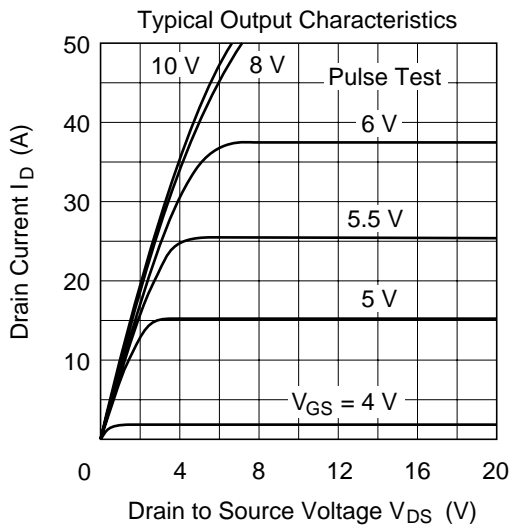
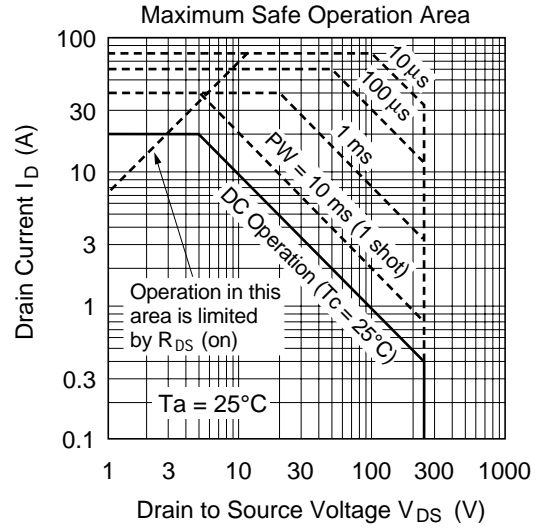
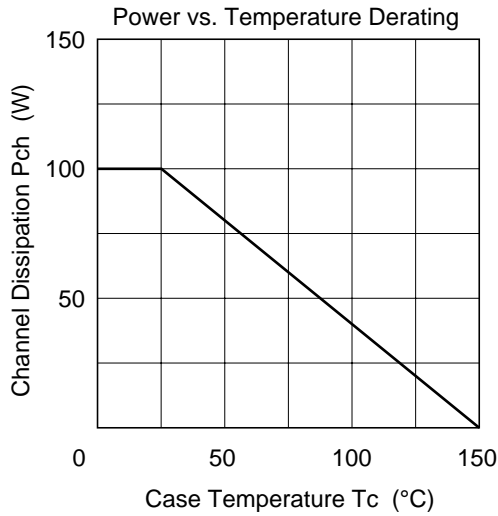

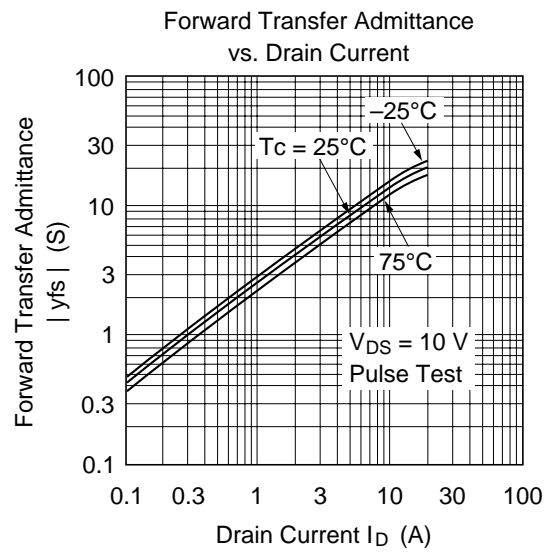
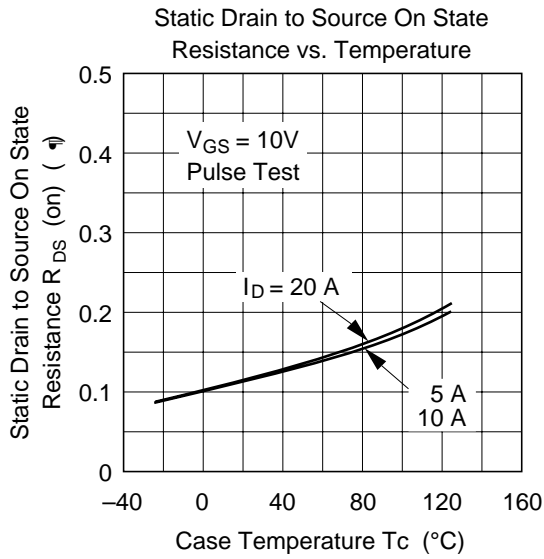
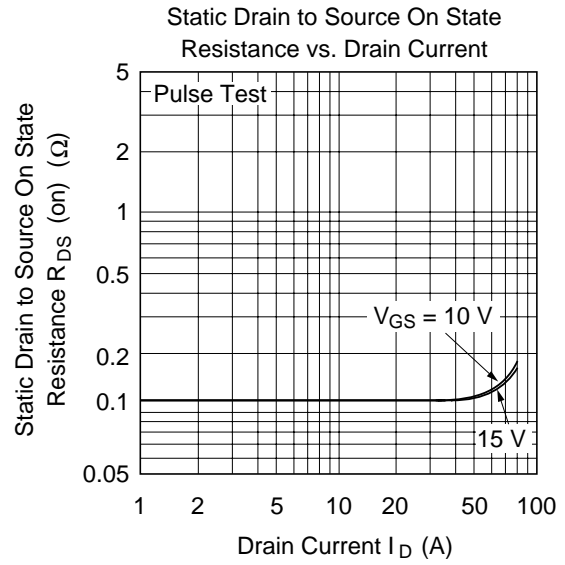
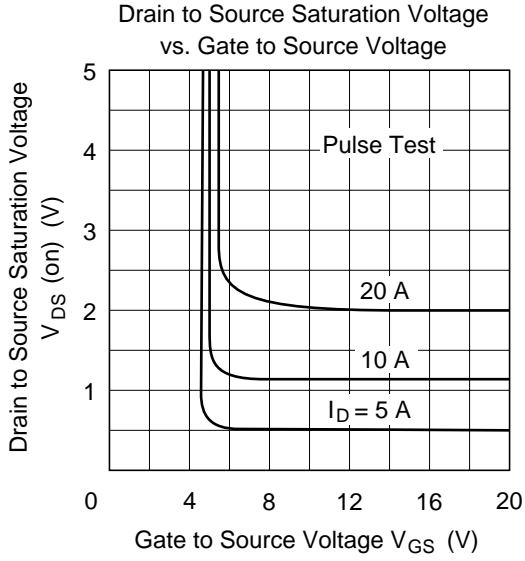

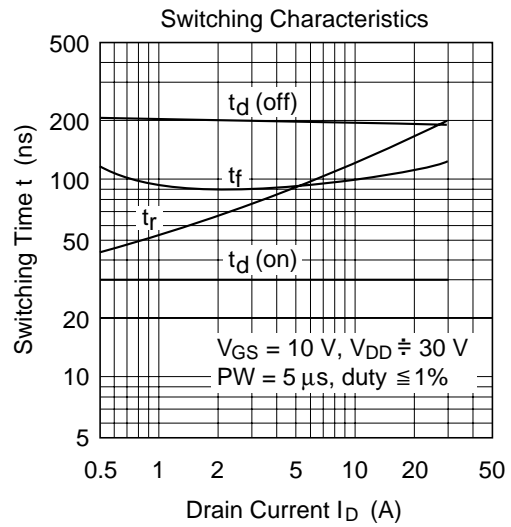
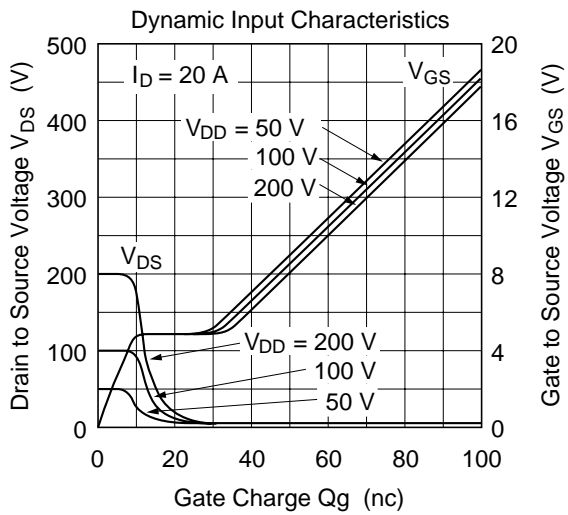
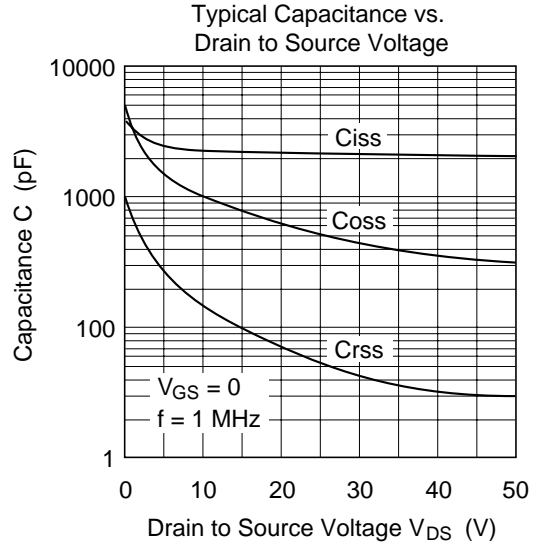
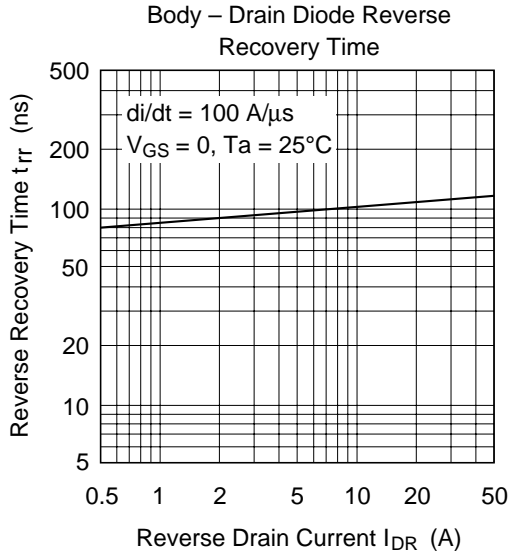

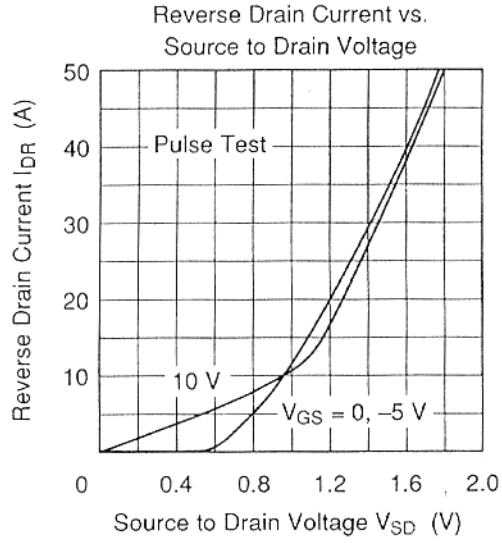

### NORMALIZED TRANSIENT THERMAL IMPEDANCE VS. PULSE WIDTH

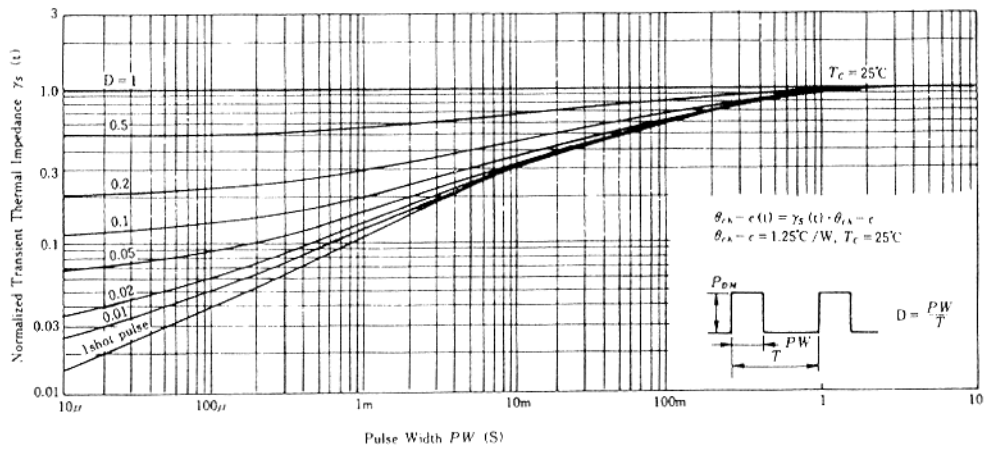

### SWITCHING TIME TEST CIRCUIT

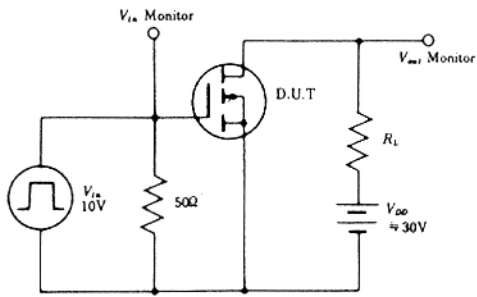

### WAVEFORMS

