

2SK2085

Silicon N Channel MOS FET

Application

High speed power switching

Features

- Low on-resistance
- High speed switching
- Low drive current
- 4 V gate drive device can be driven from 5 V source
- Suitable for Switching regulator, DC – DC converter

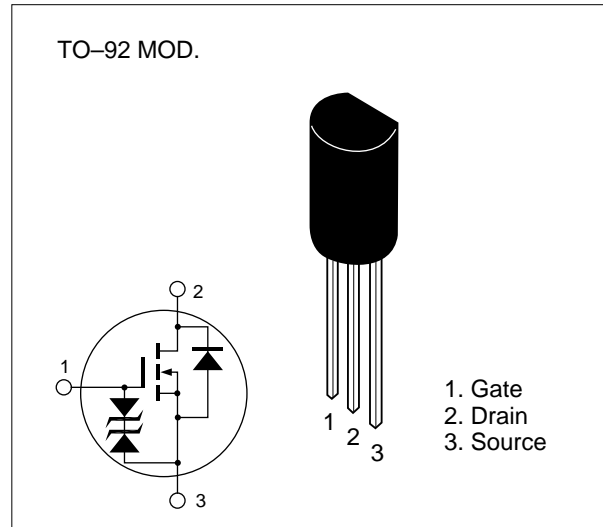

Table 1 Absolute Maximum Ratings (Ta = 25°C)

Item	Symbol	Ratings	Unit
Drain to source voltage	V _{DSS}	100	V
Gate to source voltage	V _{GSS}	±20	V
Drain current	I _D	1.0	A
Drain peak current	I _{D(pulse)} *	4.0	A
Body-drain diode reverse drain current	I _{DR}	1.0	A
Channel dissipation	P _{ch} **	0.9	W
Channel temperature	T _{ch}	150	°C
Storage temperature	T _{stg}	-55 to +150	°C

* PW ≤ 10 μs, duty cycle ≤ 1 %

** Value at T_c = 25 °C

Table 2 Electrical Characteristics (Ta = 25°C)

Item	Symbol	Min	Typ	Max	Unit	Test conditions
Drain to source breakdown voltage	$V_{(BR)DSS}$	100	—	—	V	$I_D = 10 \text{ mA}, V_{GS} = 0$
Gate to source breakdown voltage	$V_{(BR)GSS}$	±20	—	—	V	$I_G = \pm 100 \text{ } \mu\text{A}, V_{DS} = 0$
Gate to source leak current	I_{GSS}	—	—	±10	μA	$V_{GS} = \pm 16 \text{ V}, V_{DS} = 0$
Zero gate voltage drain current	I_{DSS}	—	—	100	μA	$V_{DS} = 80 \text{ V}, V_{GS} = 0$
Gate to source cutoff voltage	$V_{GS(off)}$	1.0	—	2.0	V	$I_D = 1 \text{ mA}, V_{DS} = 10 \text{ V}$
Static drain to source on state resistance	$R_{DS(on)}$	—	0.6	0.9	Ω	$I_D = 0.5 \text{ A}$ $V_{GS} = 10 \text{ V}^*$
		—	0.75	1.35	Ω	$I_D = 0.5 \text{ A}$ $V_{GS} = 4 \text{ V}^*$
Forward transfer admittance	$ y_{fs} $	0.7	1.2	—	S	$I_D = 0.5 \text{ A}$ $V_{DS} = 10 \text{ V}^*$
Input capacitance	C_{iss}	—	130	—	pF	$V_{DS} = 10 \text{ V}$
Output capacitance	C_{oss}	—	50	—	pF	$V_{GS} = 0$
Reverse transfer capacitance	C_{rss}	—	12	—	pF	$f = 1 \text{ MHz}$
Turn-on delay time	$t_{d(on)}$	—	7	—	ns	$I_D = 0.5 \text{ A}$
Rise time	t_r	—	6.5	—	ns	$V_{GS} = 10 \text{ V}$
Turn-off delay time	$t_{d(off)}$	—	55	—	ns	$R_L = 60 \text{ } \Omega$
Fall time	t_f	—	20	—	ns	
Body-drain diode forward voltage	V_{DF}	—	0.85	—	V	$I_F = 1.0 \text{ A}, V_{GS} = 0$
Body-drain diode reverse recovery time	t_{rr}	—	80	—	ns	$I_F = 1.0 \text{ A}, V_{GS} = 0,$ $di_F / dt = 50 \text{ A} / \mu\text{s}$

* Pulse Test

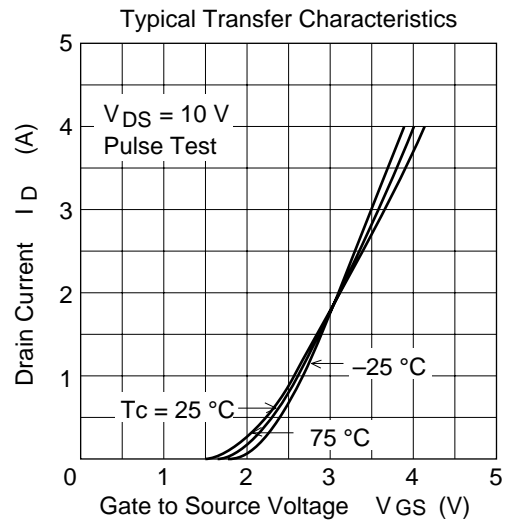
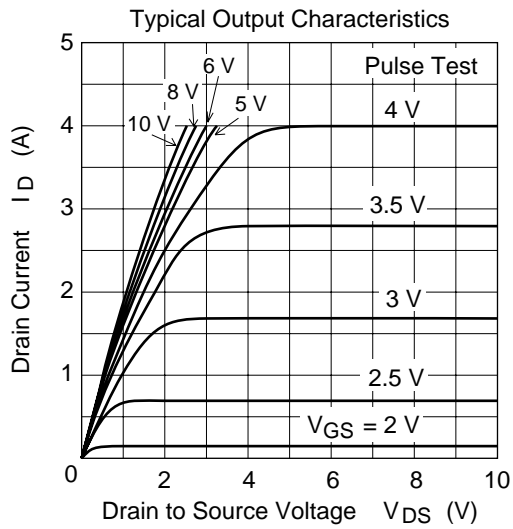
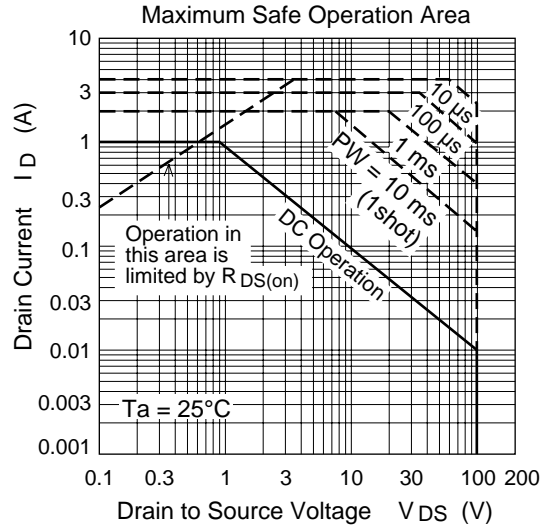
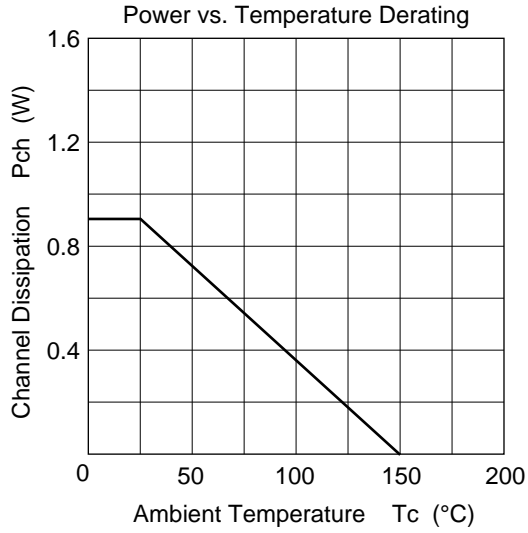

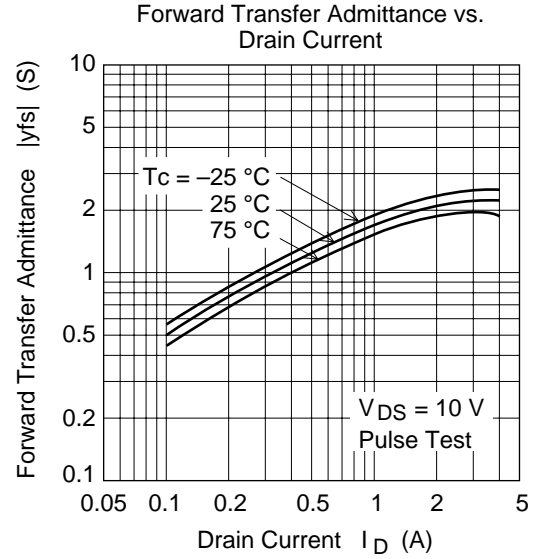
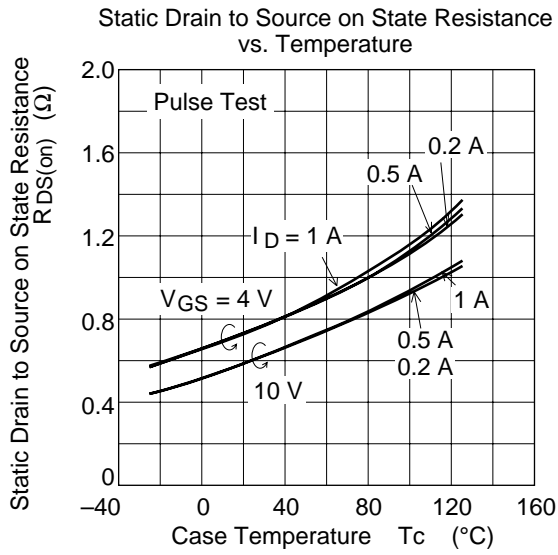
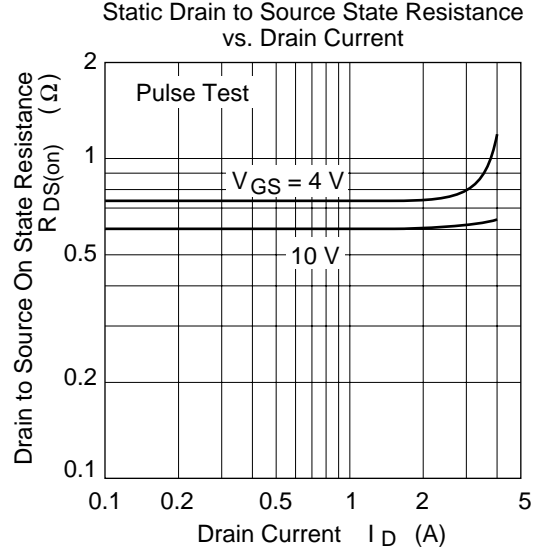
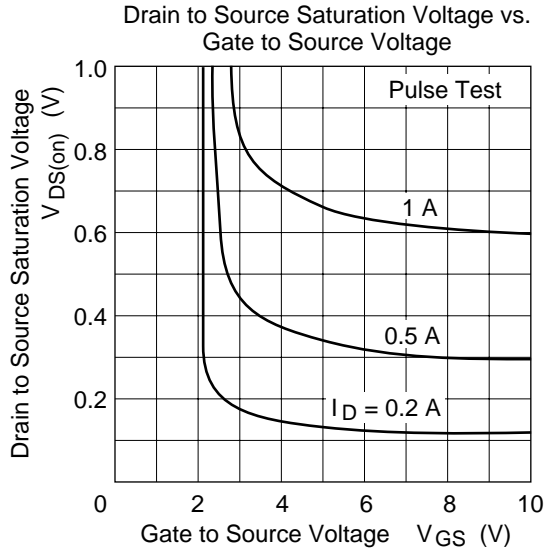

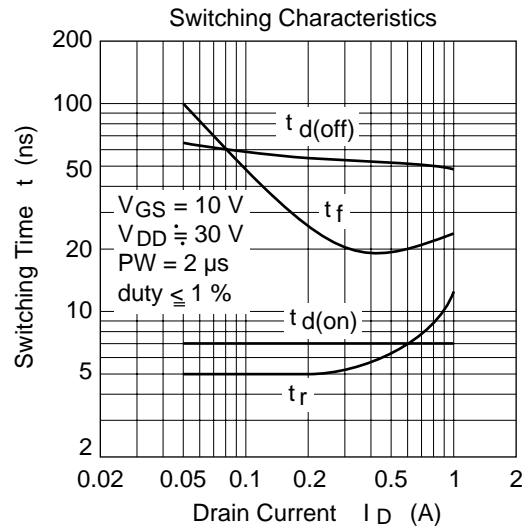
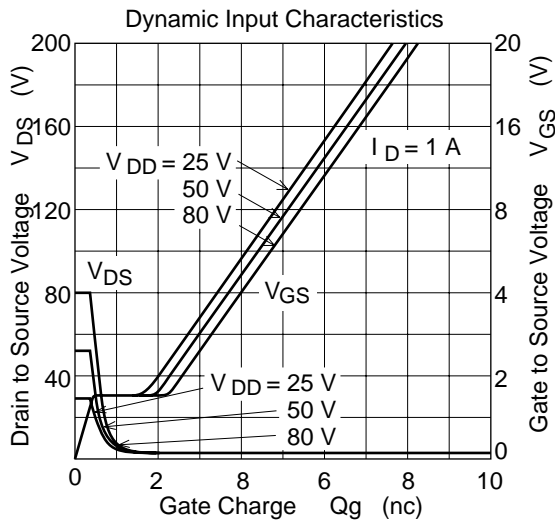
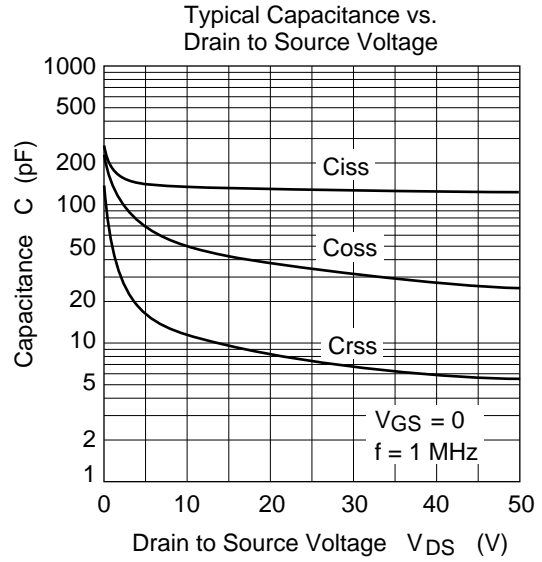
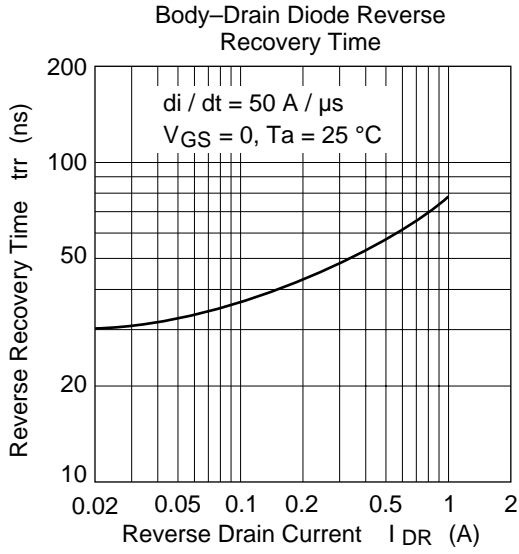

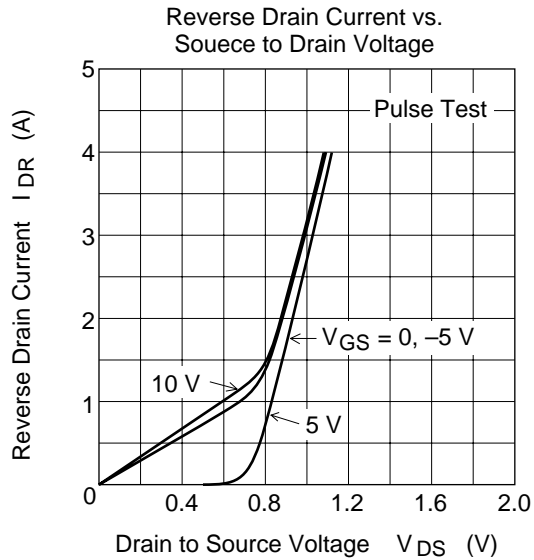

Switching Time Test Circuit

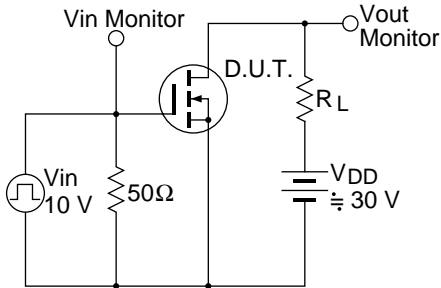

Waveform

