

# POWER MOSFET

Excellent switching capability with low on resistance, suitable for switching power supply or DC-DC converter. Taping products for use on an automatic insert machine are also available.

## Quick reference

$V_{CE0}$ [V]	60	450	500
$I_D$ [A]			
2	2SK1973 (CPT) 2SK2094 (CPT) 2SK2261 (MRT) 2SK2262 (MRT)		
5	2SK2104 (CPT)	2SK1976 (TO-220FP)	2SK2176 (TO-220FP)
10	2SK1974 (TO-220FP) 2SK2095 (TO-220FP)	2SK1975 (TO-247)	

## CPT • TO-220FP • TO-247

Application	Package				$V_{DSS}$ (V)	$I_D$ (A)	$P_D$ (W) ( $T_C=25^\circ\text{C}$ ) ( ) = MRT ( $T_a=25^\circ\text{C}$ )	$V_{GS}$ (th) (V)	$V_{DS}$ (V)	$I_D$ (mA)
	CPT	MRT	TO-220FP	TO-247						
	Part No.									
Switching	2SK1973	2SK2261	—	—	60	2	10 (1.2)	2.0~4.0	10	1
	2SK2094	2SK2262	—	—	60	2	10 (1.2)	1.0~2.5	10	1
	☆2SK2104	—	—	—	60	5	10	1.0~2.5	10	1
	—	—	2SK1974	—	60	10	30	2.0~4.0	10	1
	—	—	2SK1976	—	450	5	30	2.0~4.0	10	1
	—	—	2SK2095	—	60	10	30	1.0~2.5	10	1
	—	—	—	2SK1975	450	10	80	2.0~4.0	10	1
	—	—	2SK2176	—	500	5	30	2.0~4.0	10	1

Note : ☆Under development

## ●Product Designation

Specify part No., packaging specification code.



2 S K 1 9 7 3          T P

Part No.

Blank unless otherwise required

Packaging specification code

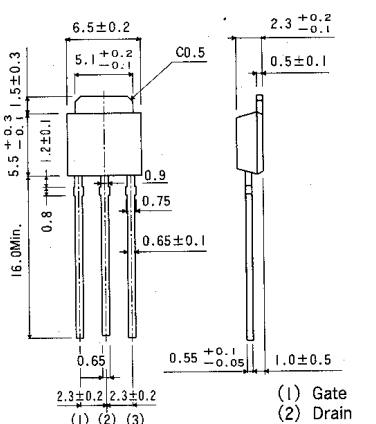
Code	Package	Packaging specifications	Quantity/Package (pcs)
—	CPT	Bulk	1,000
T105	MRT	Ammo box	2,000
—	TO-220FP	Bulk	500
C7		Tube	1,000 (50pcs × 20)
—	TO-247	Bulk	200
F31		Packed in forming tray	500

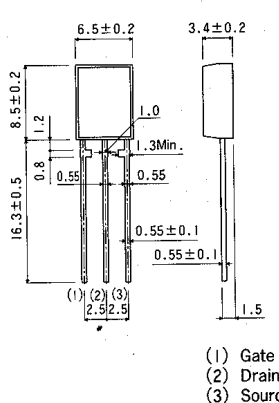
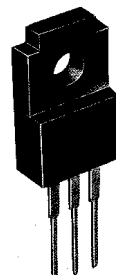
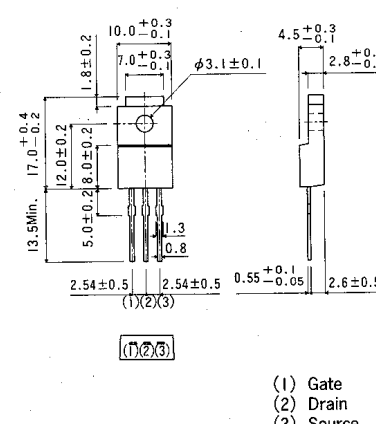
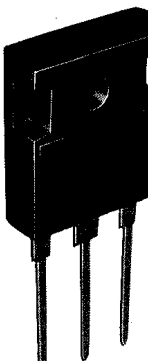
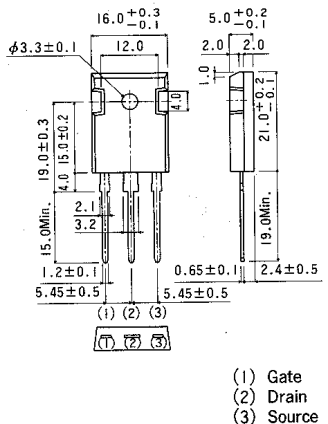
<p><b>CPT</b></p> 	 <p>(1) Gate (2) Drain (3) Source</p>	<p><b>MRT</b></p> 	 <p>(1) Gate (2) Drain (3) Source</p>
<p><b>TO-220FP</b></p> 	 <p>(1) Gate (2) Drain (3) Source</p>	<p><b>TO-247</b></p> 	 <p>(1) Gate (2) Drain (3) Source</p>

●Packaging

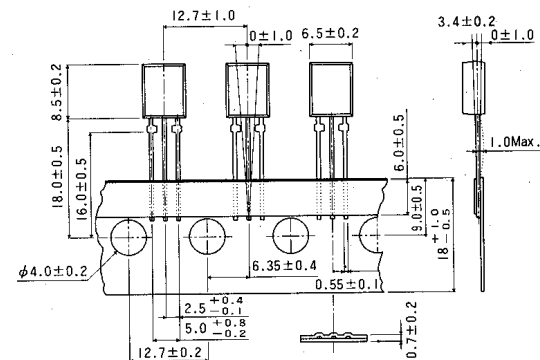
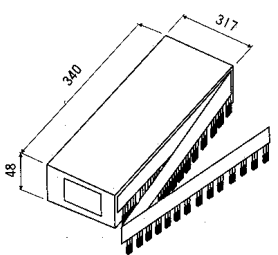
<p><b>MRT Taping</b></p> 	<p><b>MRT Ammo box</b></p> 
--	--

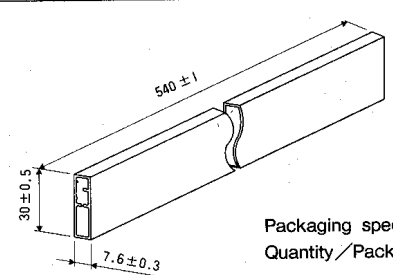
<p><b>TO-220FP Container tube</b></p>  <p>Packaging specification code : C7 Quantity / Package : 50pcs</p>
--