

SPECIFICATION

DEVICE NAME : Power MOSFET

TYPE NAME : 2SK2522-01MR

SPEC. No. : - - - -

Fuji Electric Co.,Ltd.

This Specification is subject to change without notice.

	DATE	NAME	APPROVED	Fuji Electric Co.,Ltd.		
DRAWN				DWG.NO.	1/11	
CHECKED						

1. Scope
This specifies Fuji power MOSFET 2SK2522-01MR
2. Construction N-channel enhancement mode power MOSFET
3. Application for switching
4. Outview TO-220F Outviwe See to 5/11 page
5. Absolute maximum ratings at Tc=25°C (unless otherwise specified)

Description	Symbol	Characteristics	Unit	Remarks
Drain-source voltage	V_{DS}	200	V	
Drain-gate voltage	V_{DGR}	200	V	$R_{GS} = 20\text{K}\Omega$
Continuous Drain current	I_D	± 18	A	
Pulsed drain current	I_{Dpulso}	± 72	A	
Gate-source voltage	V_{GS}	± 30	V	
Maximum power dissipation	P_D	40	W	
Operating and storage temperature range	T_{ch}	150	°C	
	T_{sto}	-55 ~ +150	°C	

6. Electrical characteristics at Tc=25°C (unless otherwise specified)
Static ratings

Description	Symbol	Conditions	Characteristics			Unit
			Min.	Typ.	Max.	
Drain-source breakdown voltage	BV_{DSS}	$I_D = 1\text{mA}$ $V_{GS} = 0\text{V}$	200			V
Gate threshold voltage	$V_{GS(th)}$	$I_D = 1\text{mA}$ $V_{DS} = V_{GS}$	2.5	3.0	3.5	V
Zero gate voltage drain current	I_{DSS}	$V_{DS} = 200\text{V}$ $V_{GS} = 0\text{V}$	$T_{ch} = 25^\circ\text{C}$	10	500	μA
	I_{DSS}		$T_{ch} = 125^\circ\text{C}$	0.2	1.0	mA
Gate-source leakage current	I_{GSS}	$V_{GS} = \pm 30\text{V}$ $V_{DS} = 0\text{V}$		10	100	nA
Drain-source on-state resistance	$R_{DS(on)}$	$I_D = 9\text{A}$ $V_{GS} = 10\text{V}$		0.15	0.18	Ω

Dynamic ratings

Description	Symbol	Conditions	Characteristics			Unit
			Min.	Typ.	Max.	
Forward transconductance	g_{fs}	$I_o = 9\text{ A}$ $V_{DS} = 25\text{ V}$	4.0	9.0		S
Input capacitance	C_{iss}	$V_{DS} = 25\text{ V}$ $V_{GS} = 0\text{ V}$ $f = 1\text{ MHz}$		1100	1650	pF
Output capacitance	C_{oss}			220	330	pF
Reverse transfer capacitance	C_{rss}			100	150	pF
Turn-on time	$t_{d(on)}$	$V_{CC} = 150\text{ V}$ $V_{GS} = 10\text{ V}$ $I_o = 18\text{ A}$ $R_{GS} = 10\ \Omega$		15	30	ns
	t_r			80	120	ns
Turn-off time	$t_{d(off)}$			60	90	ns
	t_f			40	60	ns

Reverse diode

Description	Symbol	Conditions	Characteristics			Unit
			Min.	Typ.	Max.	
Avalanche capability	I_{AV}	$L = 100\ \mu\text{H}$, $T_{ch} = 25^\circ\text{C}$ * see Fig1 and Fig2	18.0			A
Diode forward on-voltage	V_{SD}	$I_F = 2 \times I_{OR}$ $V_{GS} = 0\text{ V}$, $T_{ch} = 25^\circ\text{C}$		1.5	2.25	V
Reverse recovery time	t_{rr}	$I_F = I_{OR}$ $V_{GS} = 0\text{ V}$ $-di_F/dt = 100\text{ A}/\mu\text{s}$ $T_{ch} = 25^\circ\text{C}$		165		ns
Reverse recovery charge	Q_{rr}				1300	

7. Thermal resistance

Description	Symbol	Conditions	Characteristics			Unit
			Min.	Typ.	Max.	
Thermal resistance	$R_{th_{ch-c}}$				3.125	$^\circ\text{C}/\text{W}$
	$R_{th_{ch-a}}$				62.5	$^\circ\text{C}/\text{W}$

Fig.1 Test circuit

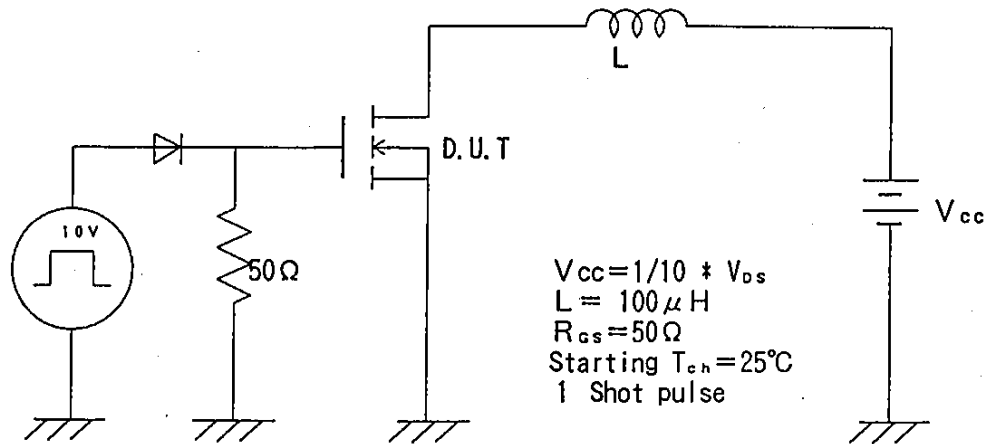
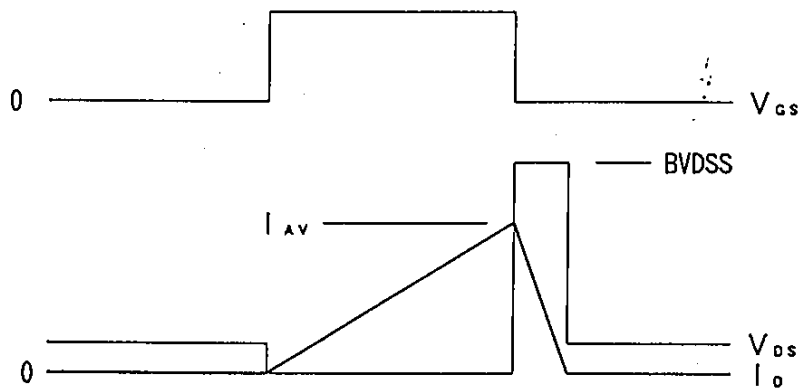
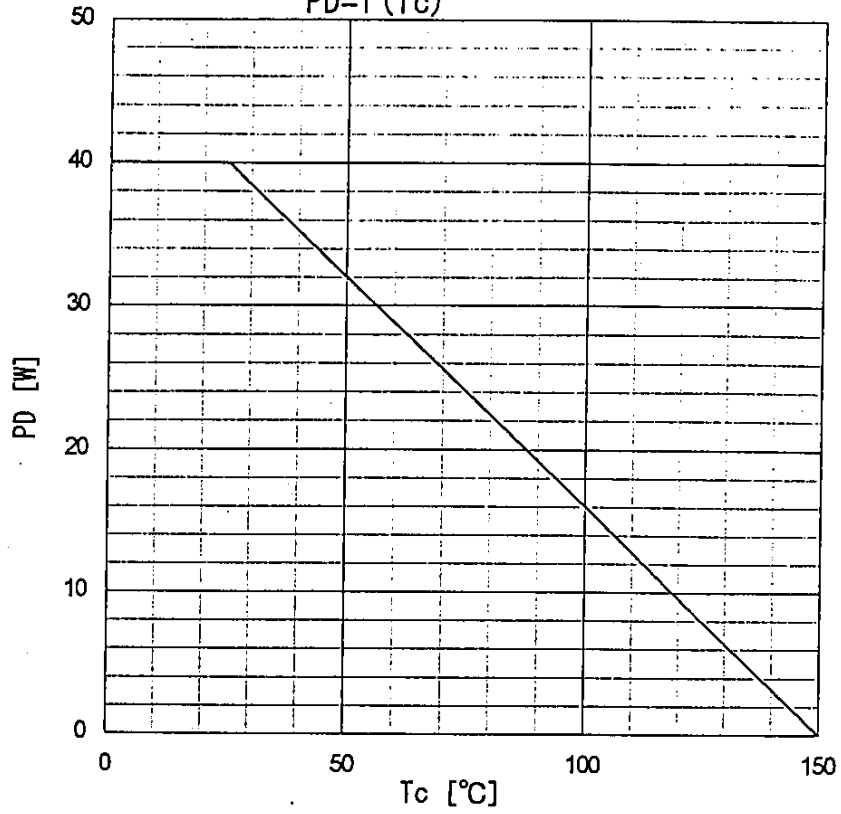

Fig.2 Operating waveforms



Power Dissipation
 $PD=f(T_c)$



Safe operating area
 $ID=f(V_{DS}) : D=0.01, T_c=25^\circ C$

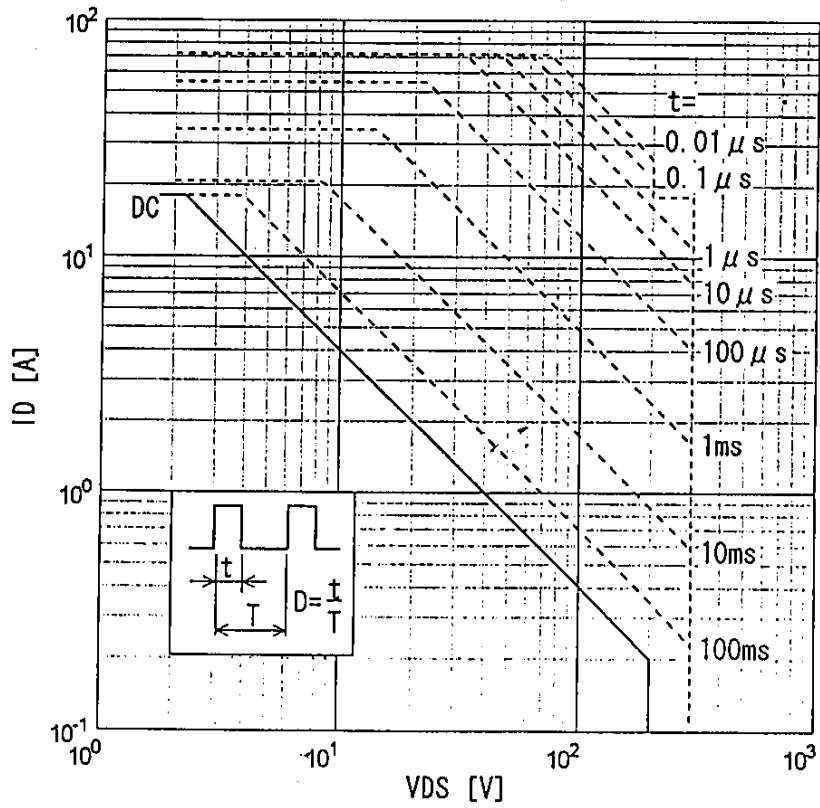

Typical output characteristics
 $I_D = f(V_{DS}) : 80 \mu s$ pulse test, $T_{ch} = 25^\circ C$

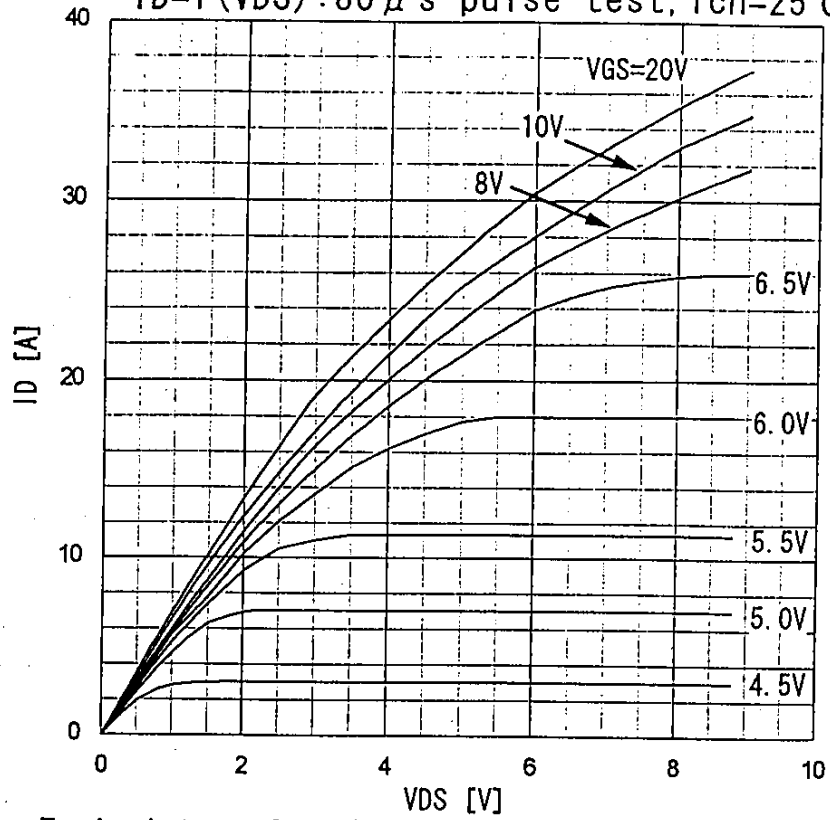

Typical transfer characteristic
 $I_D = f(V_{GS}) : 80 \mu s$ pulse test, $V_{DS} = 25V$, $T_{ch} = 25^\circ C$

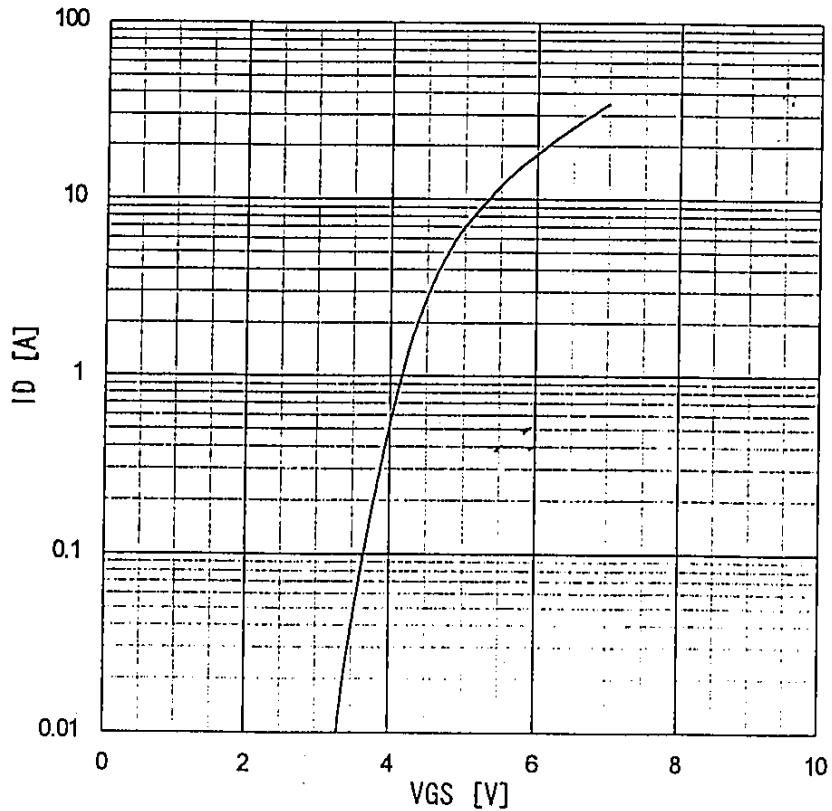

Typical transconductance

$g_{fs} = f(I_D)$: 80 μ s pulse test, $V_{DS} = 25V$, $T_{ch} = 25^\circ C$

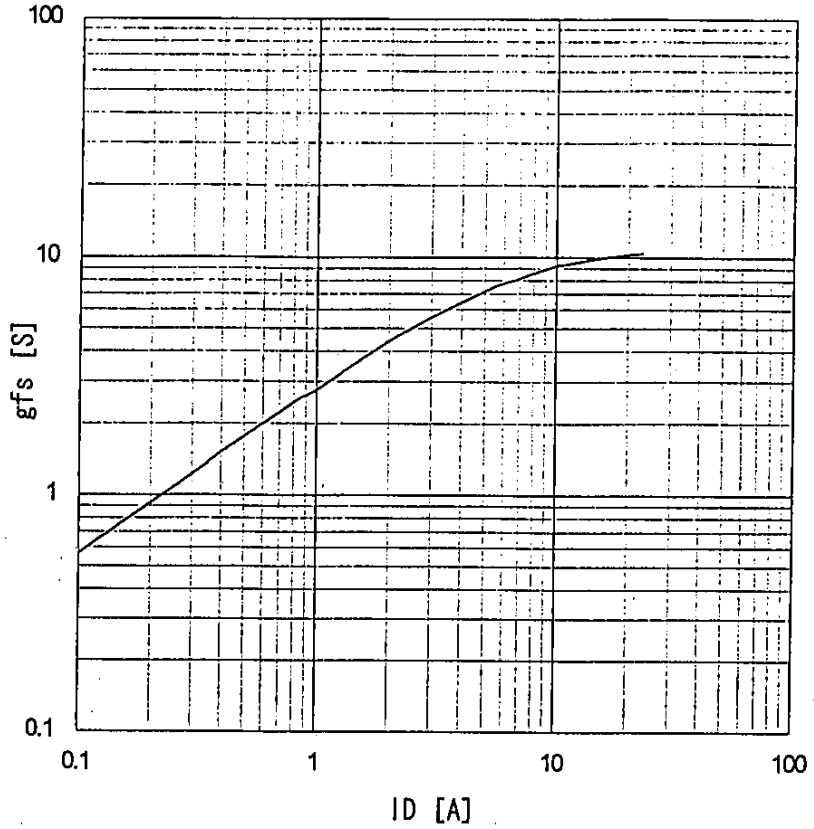

Typical drain-source on-state resistance

$R_{DS(on)} = f(I_D)$: 80 μ s pulse test, $T_{ch} = 25^\circ C$

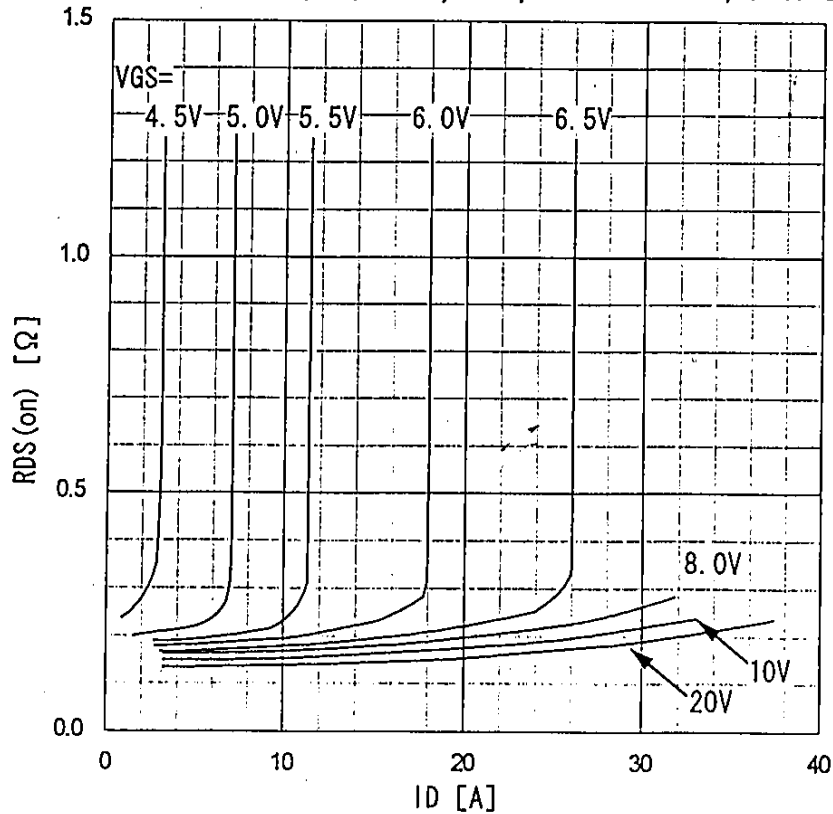

Drain-source on-state resistance
 $R_{DS(on)} = f(T_{ch}) : I_D = 9A, V_{GS} = 10V$

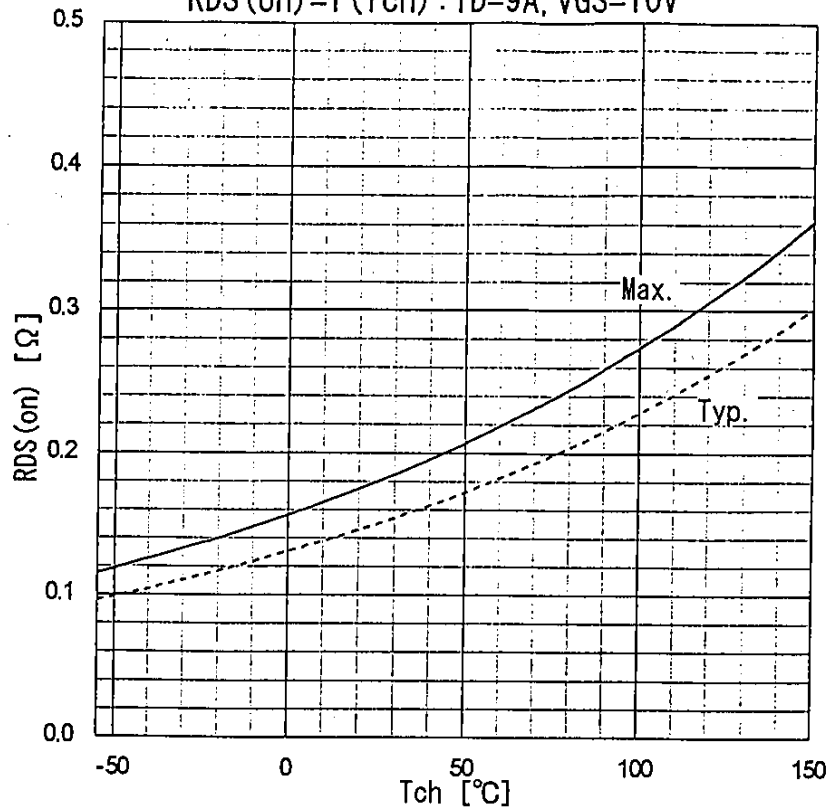

Gate threshold voltage
 $V_{GS(th)} = f(T_{ch}) : I_D = 1mA, V_{DS} = V_{GS}$

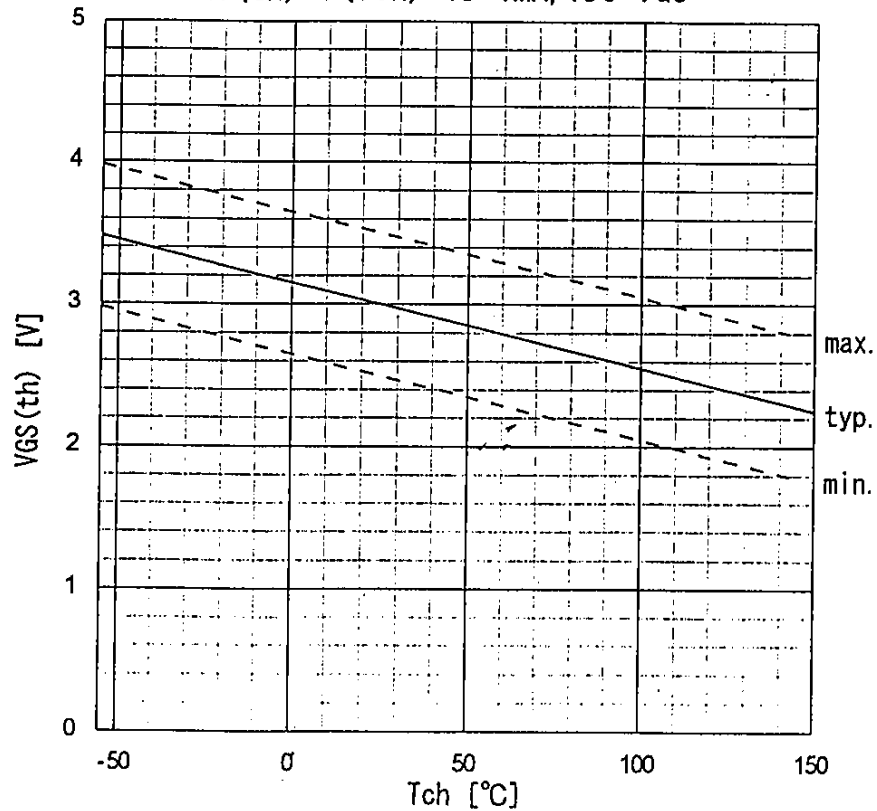

Typical Capacitances
 $C=f(V_{DS}) : V_{GS}=0V, f=1MHz$

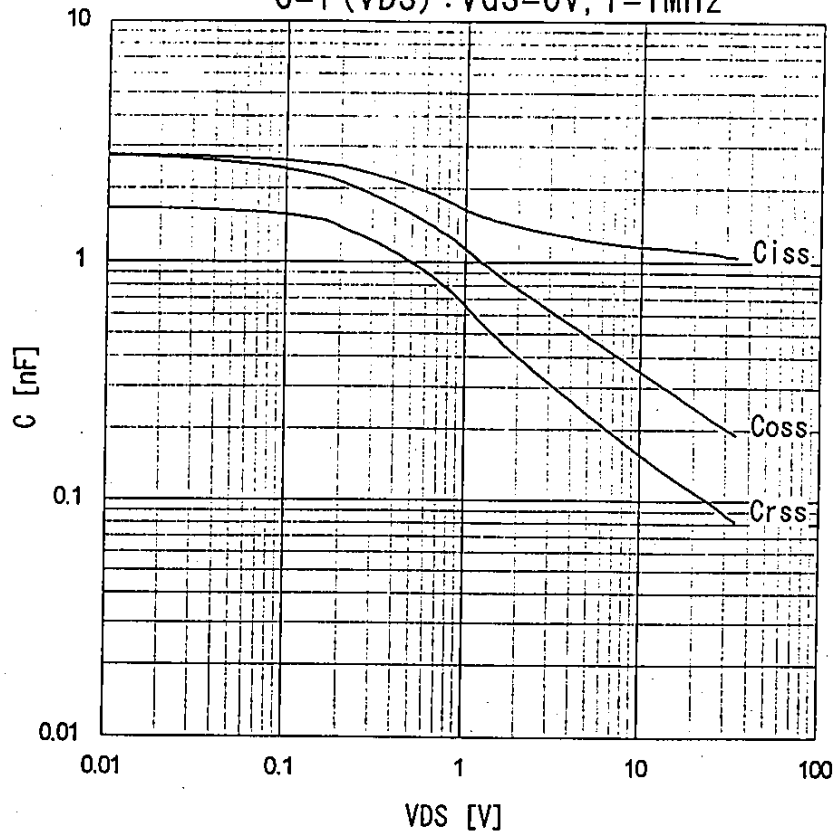

Typical gate charge characteristics
 $V_{GS}=f(Q_g) : I_D=18A$

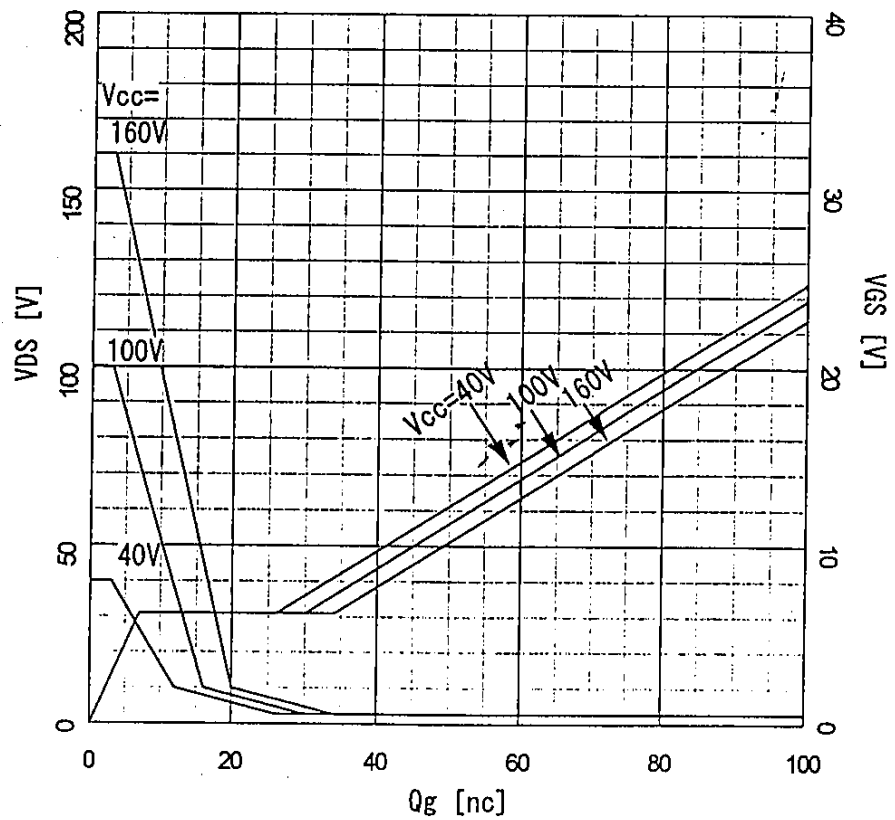

Forward characteristic of reverse diode
 $I_F = f(V_{SD}) : 80 \mu s$ pulse test $T_{ch} = 25^\circ C$ $V_{GS} = 0V$

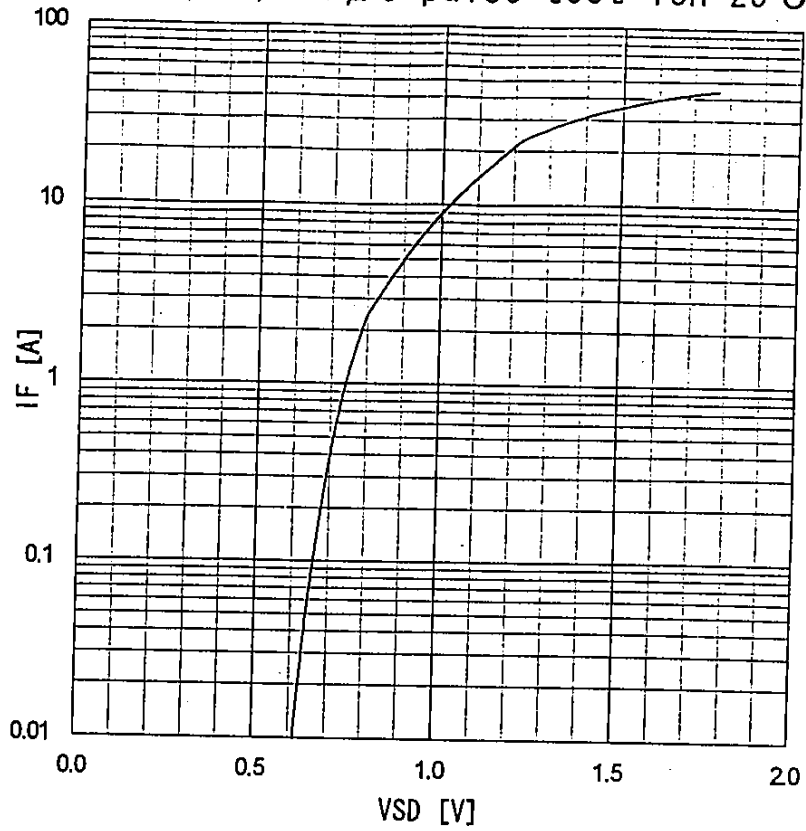

Transient thermal impedande
 $Z_{th}(ch-c) = f(t)$ parameter: $D = t/T$

