

SPECIFICATION

(TENTATIVE)

DEVICE NAME : Power MOSFET

TYPE NAME : 2SK2759-01R

SPEC. No. :

Fuji Electric Co.,Ltd.

This Specification is subject to change without notice.

	DATE	NAME	APPROVED	Fuji Electric Co.,Ltd.		
DRAWN				DWG.NO.	1/12	
CHECKED						

1. Scope
This specifies Fuji power MOSFET 2SK2759-01R
2. Construction N-channel enhancement mode power MOSFET
3. Application for switching
4. Outview TO-3PF Outview See to 5/12 page
5. Absolute maximum ratings at $T_c=25^\circ\text{C}$ (unless otherwise specified)

Description	Symbol	Characteristics	Unit	Remarks
Drain-source voltage	V_{DS}	500	V	
Continuous Drain current	I_D	± 15	A	
Pulsed drain current	I_{Dpulv}	± 60	A	
Gate-source voltage	V_{GS}	± 30	V	
Repetitive or non-repetitive	I_{AR}	15	A	$T_{ch} \leq 150^\circ\text{C}$
Avalanche energy	E_{AS}	108	mJ	See page 12/12 ※
Maximum power dissipation	P_D	80	W	
Operating and storage temperature range	T_{ch}	150	$^\circ\text{C}$	
	T_{stg}	-55 ~ +150	$^\circ\text{C}$	

※ $L=0.88\text{mH}$, $V_{cc}=50\text{V}$

6. Electrical characteristics at $T_c=25^\circ\text{C}$ (unless otherwise specified)
- Static ratings

Description	Symbol	Conditions	Characteristics			Unit
			Min.	Typ.	Max.	
Drain-source breakdown voltage	BV_{DSS}	$I_D = 1\text{mA}$ $V_{GS} = 0\text{V}$	500			V
Gate threshold voltage	$V_{GS(th)}$	$I_D = 1\text{mA}$ $V_{DS} = V_{GS}$	3.5	4.0	4.5	V
Zero gate voltage drain current	I_{DSS}	$V_{DS} = 500\text{V}$ $V_{GS} = 0\text{V}$	$T_{ch} = 25^\circ\text{C}$	10	500	μA
	I_{DSS}		$T_{ch} = 125^\circ\text{C}$	0.2	1.0	mA
Gate-source leakage current	I_{GSS}	$V_{GS} = \pm 30\text{V}$ $V_{DS} = 0\text{V}$		10	100	nA
Drain-source on-state resistance	$R_{DS(on)}$	$I_D = 7.5\text{A}$ $V_{GS} = 10\text{V}$		0.44	0.55	Ω

Fuji Electric Co., Ltd.

DWG. NO.

2/12

Y 0257-R-003a

Dynamic ratings

Description	Symbol	Conditions	Characteristics			Unit
			Min.	Typ.	Max.	
Forward transconductance	g_{fs}	$I_D = 7.5A$ $V_{DS} = 25V$	4.5	9.0		S
Input capacitance	C_{iss}	$V_{DS} = 25V$ $V_{GS} = 0V$ $f = 1MHz$		1400	2100	pF
Output capacitance	C_{oss}			250	380	pF
Reverse transfer capacitance	C_{rss}			110	170	pF
Turn-on time	$t_{d(on)}$	$V_{CC} = 300V$ $V_{GS} = 10V$ $I_D = 15A$ $R_{GS} = 10\Omega$		30	50	ns
	t_r			110	170	ns
Turn-off time	$t_{d(off)}$			90	140	ns
	t_f			55	90	ns

Reverse diode

Description	Symbol	Conditions	Characteristics			Unit
			Min.	Typ.	Max.	
Avalanche capability	I_{AV}	$L = 100\mu H$, $T_{ch} = 25^\circ C$ * See Fig1 and 2	15			A
Diode forward on-voltage	V_{SD}	$I_F = 2 \times I_{DR}$ $V_{GS} = 0V$, $T_{ch} = 25^\circ C$		1.1	1.65	V
Reverse recovery time	t_{rr}	$I_F = I_{DR}$ $V_{GS} = 0V$ $-di_F/dt = 100A/\mu s$ $T_{ch} = 25^\circ C$		500		ns
Reverse recovery charge	Q_{rr}			8.0		μC

7. Thermal resistance

Description	Symbol	Conditions	Characteristics			Unit
			Min.	Typ.	Max.	
Thermal resistance	$R_{th_{ch-c}}$				1.56	$^\circ C/W$
	$R_{th_{ch-a}}$				30.0	$^\circ C/W$

Fig.1 Test circuit

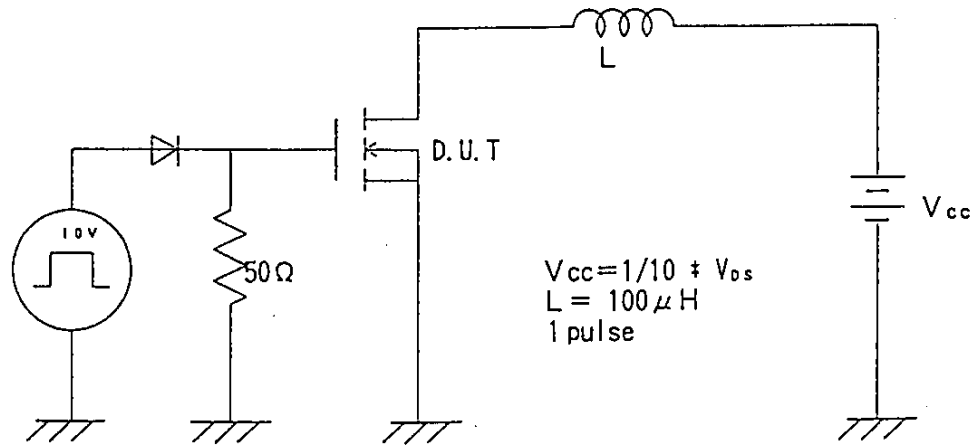
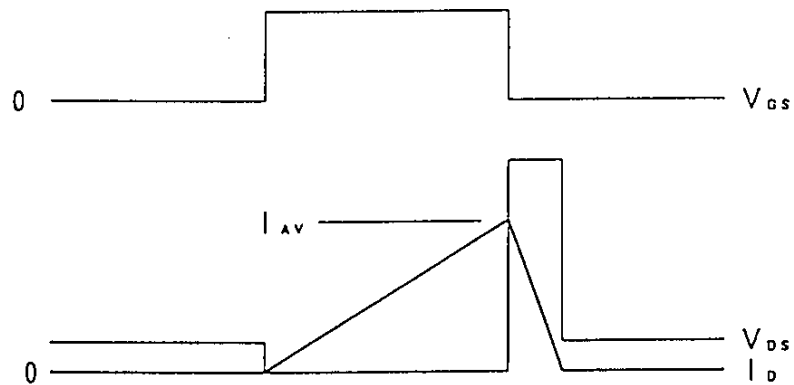
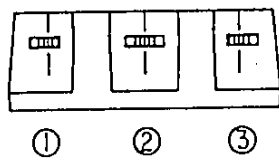
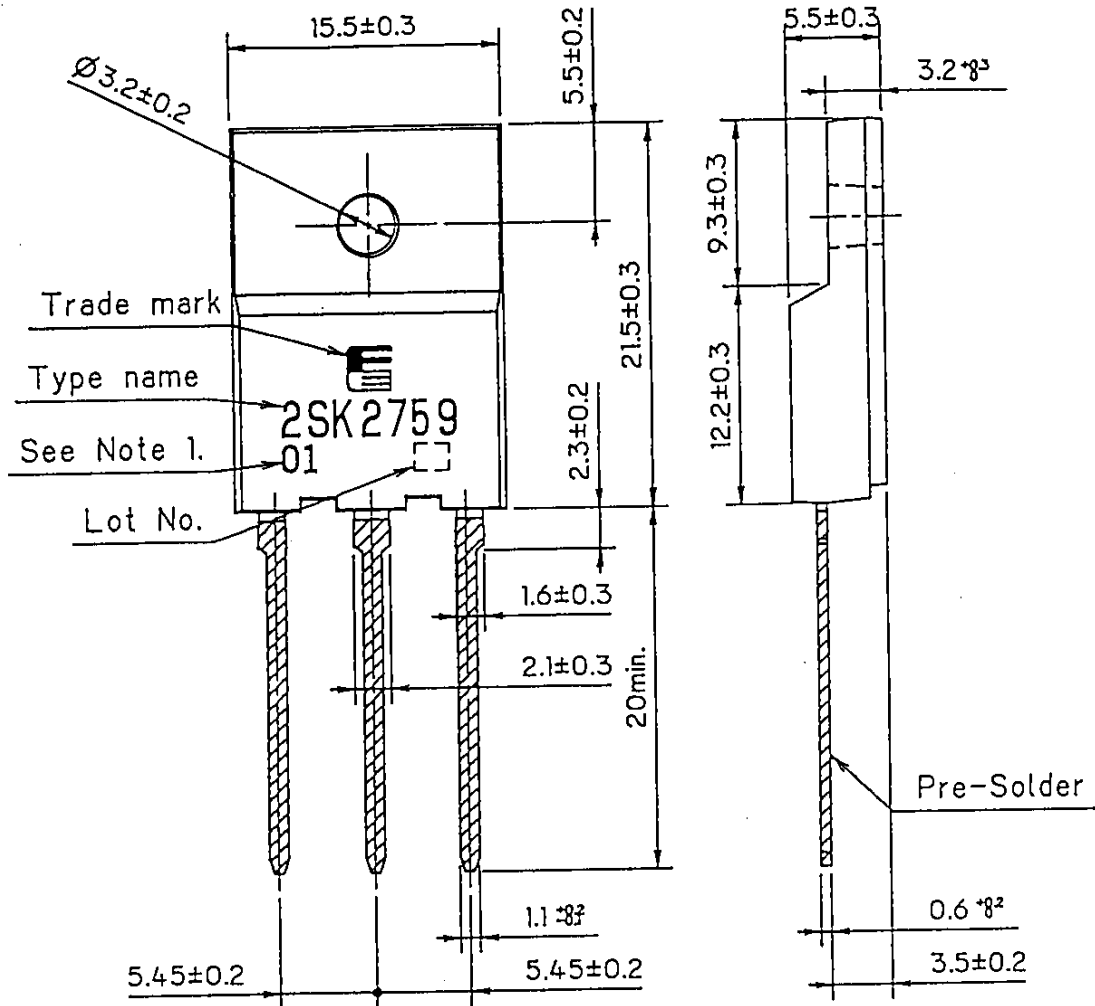

Fig.2 Operating waveforms



FUJI POWER MOSFET

TYPE : 2SK2759-01R



CONNECTION

- ① GATE
- ② DRAIN
- ③ SOURCE

Note 1. Guaranteed mark of avalanche ruggedness.

DIMENSIONS ARE IN MILLIMETERS.

Fuji Electric Co.,Ltd.

DWG. NO.

5/12

Power Dissipation
 $PD=f(T_c)$

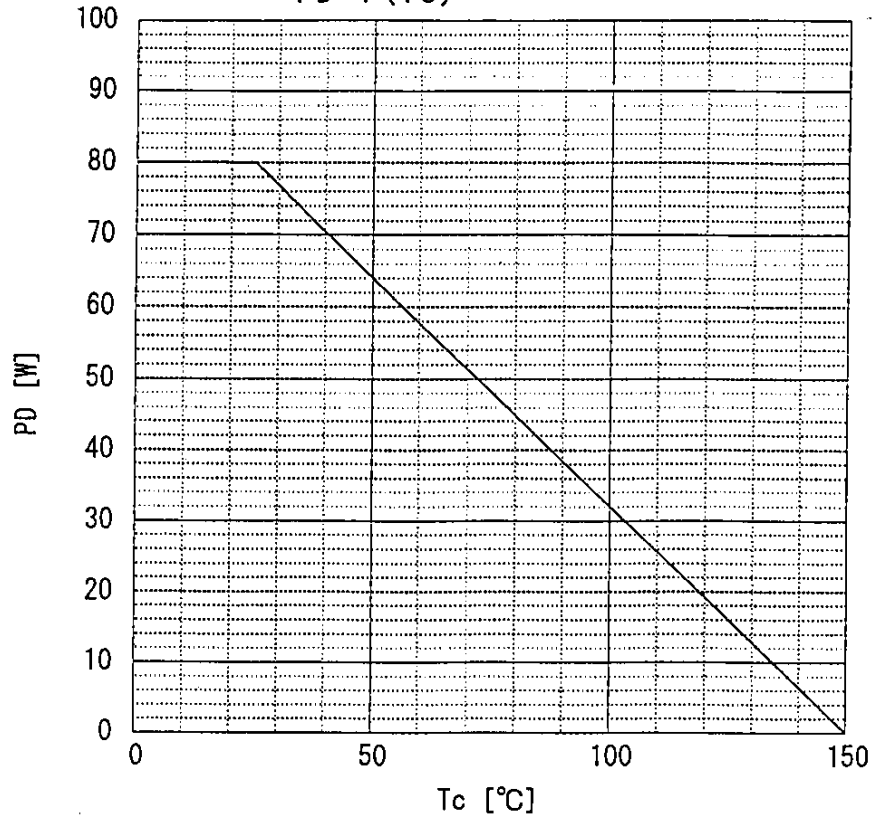

Safe operating area
 $ID=f(V_{DS}) : D=0.01, T_c=25^\circ\text{C}$

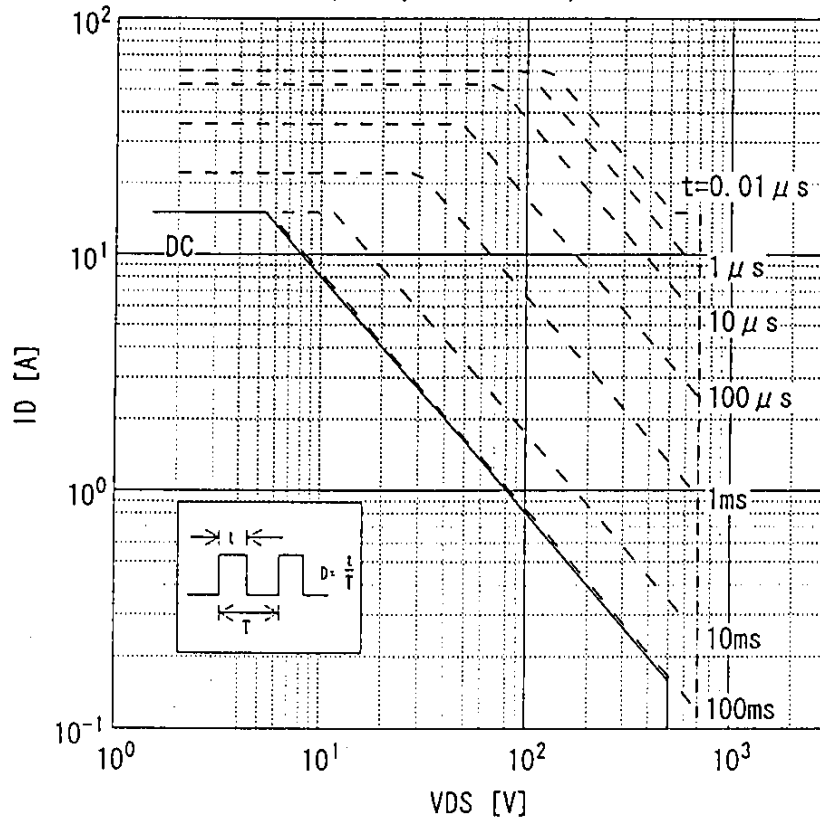

Typical output characteristics
 $I_D = f(V_{DS})$: 80 μ s pulse test, $T_c = 25^\circ\text{C}$

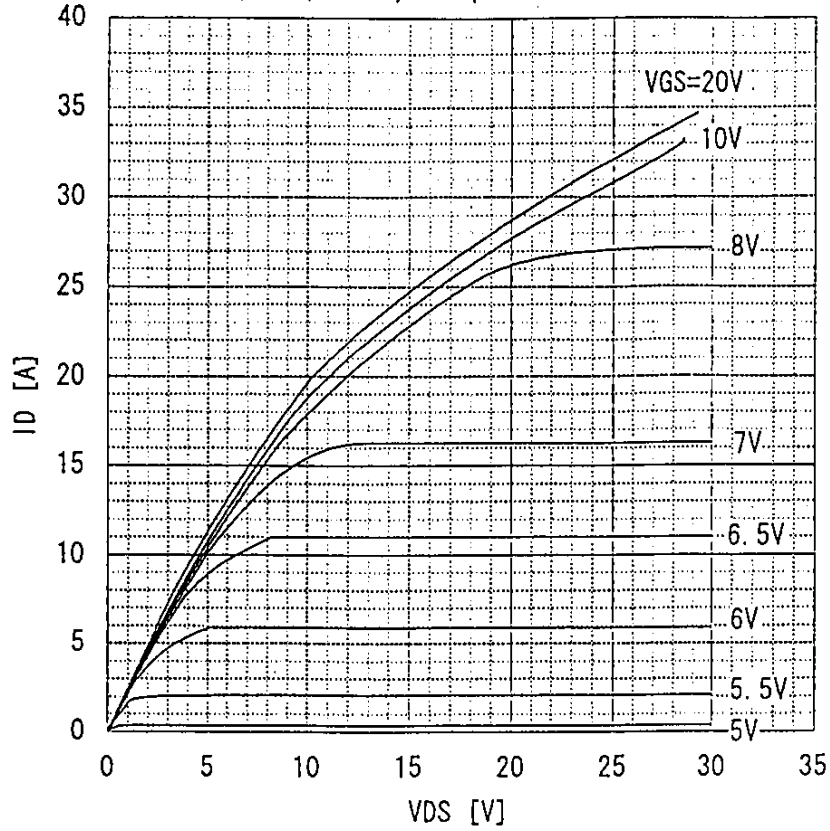

Typical transfer characteristic
 $I_D = f(V_{GS})$: 80 μ s pulse test, $V_{DS} = 25\text{V}$, $T_{ch} = 25^\circ\text{C}$

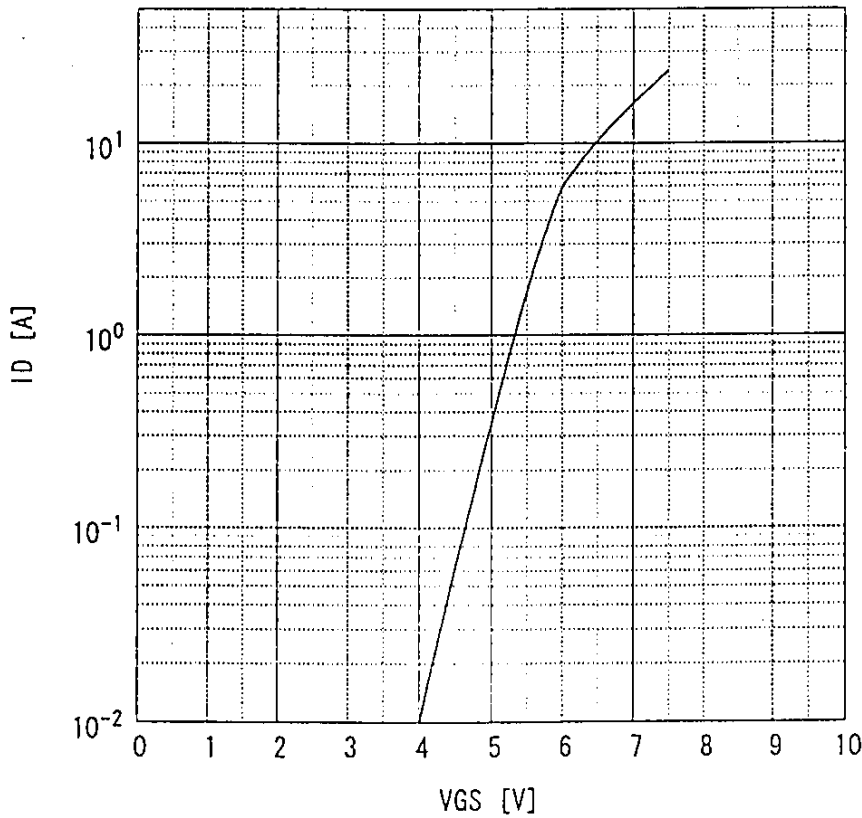

Typical forward transconductance
 $g_{fs} = f(I_D)$: 80 μ s pulse test, $V_{DS} = 25V$, $T_{ch} = 25^\circ C$

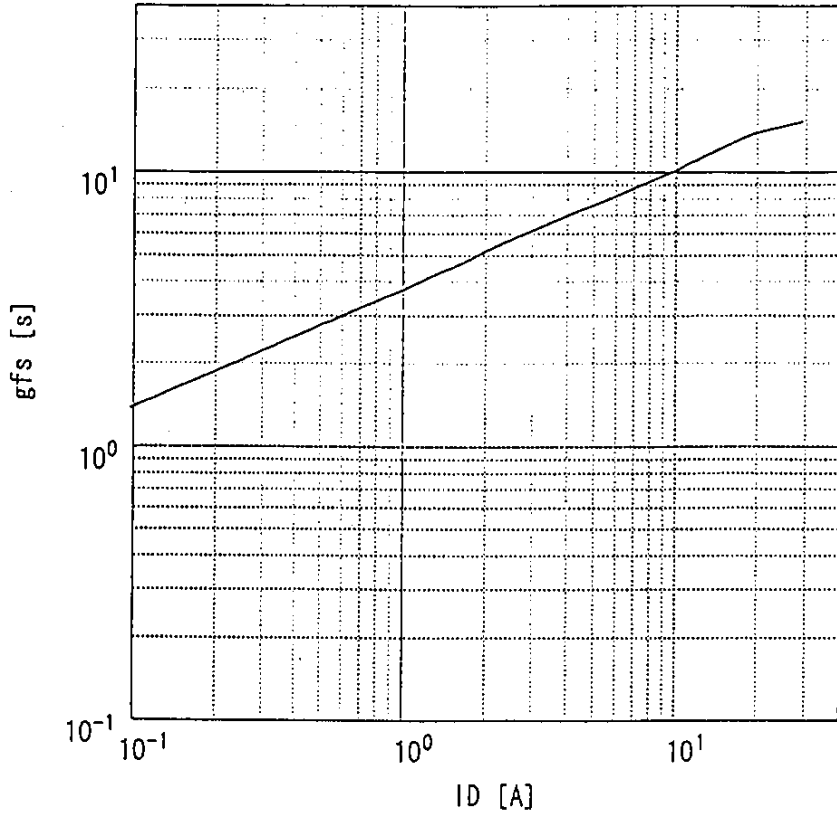

Typical drain-source on-state resistance
 $R_{DS(on)} = f(I_D)$: 80 μ s pulse test, $T_c = 25^\circ C$

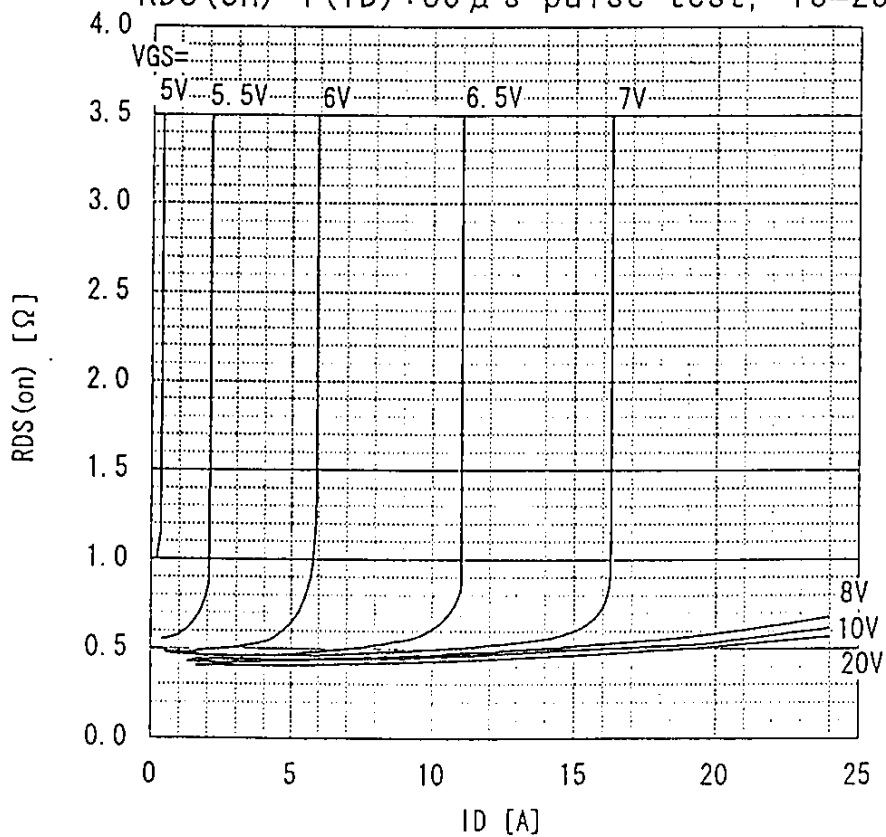

Drain-source on-state resistance
 $R_{DS(on)} = f(T_{ch}) : I_D = 7.5A, V_{GS} = 10V$

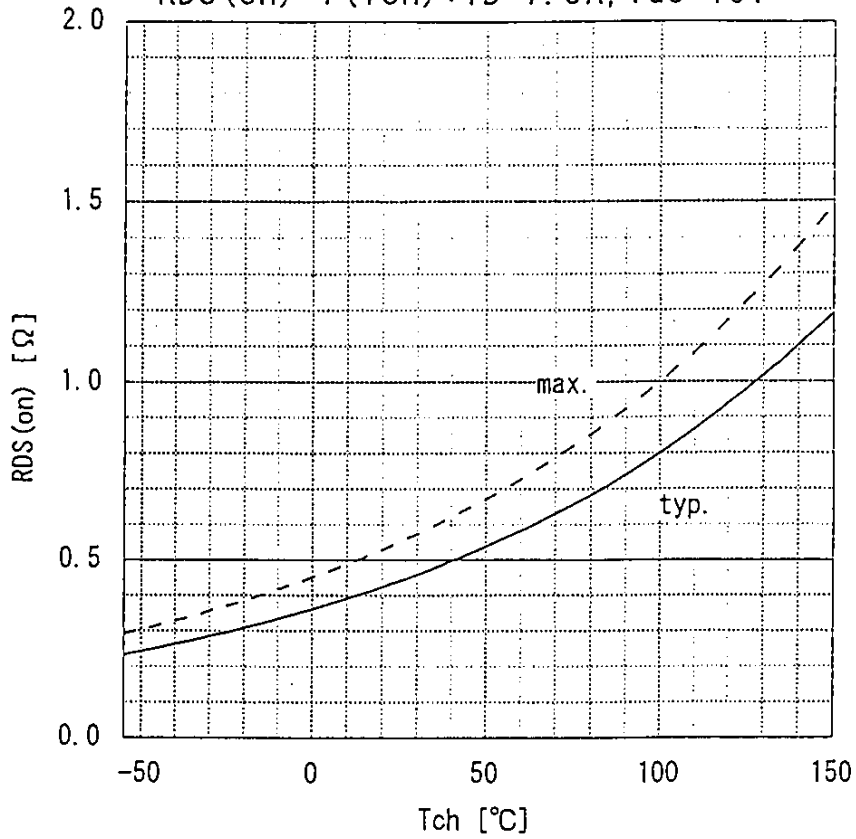

Gate threshold voltage
 $V_{GS(th)} = f(T_{ch}) : I_D = 1mA, V_{DS} = V_{GS}$

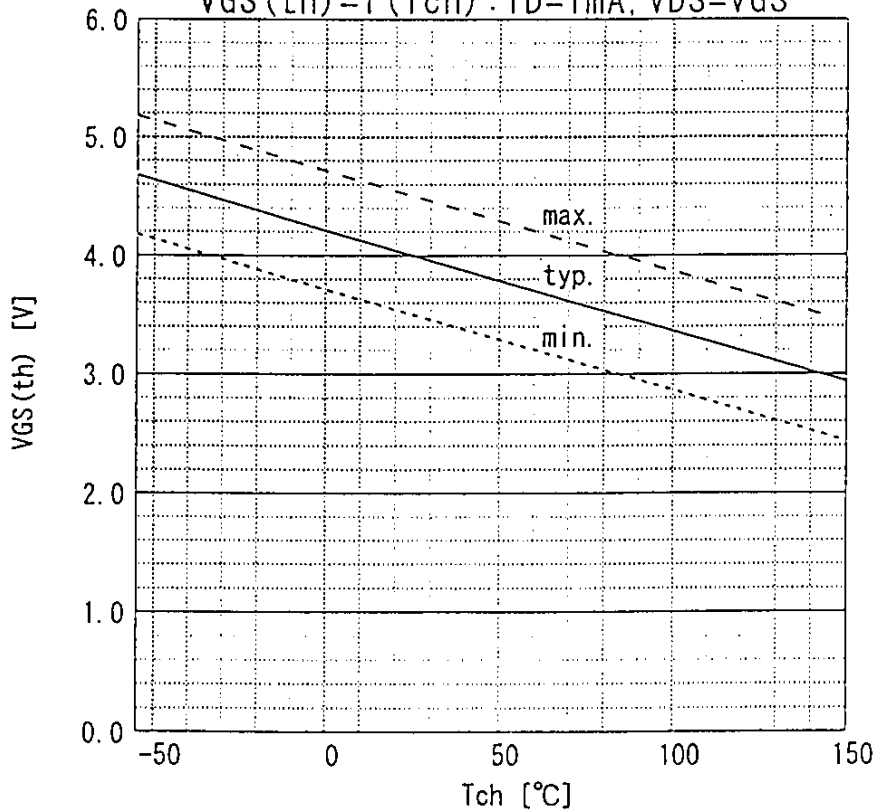

Typical gate charge characteristic
 $V_{GS} = f(Q_g) : I_D = 15A, T_c = 25^\circ C$

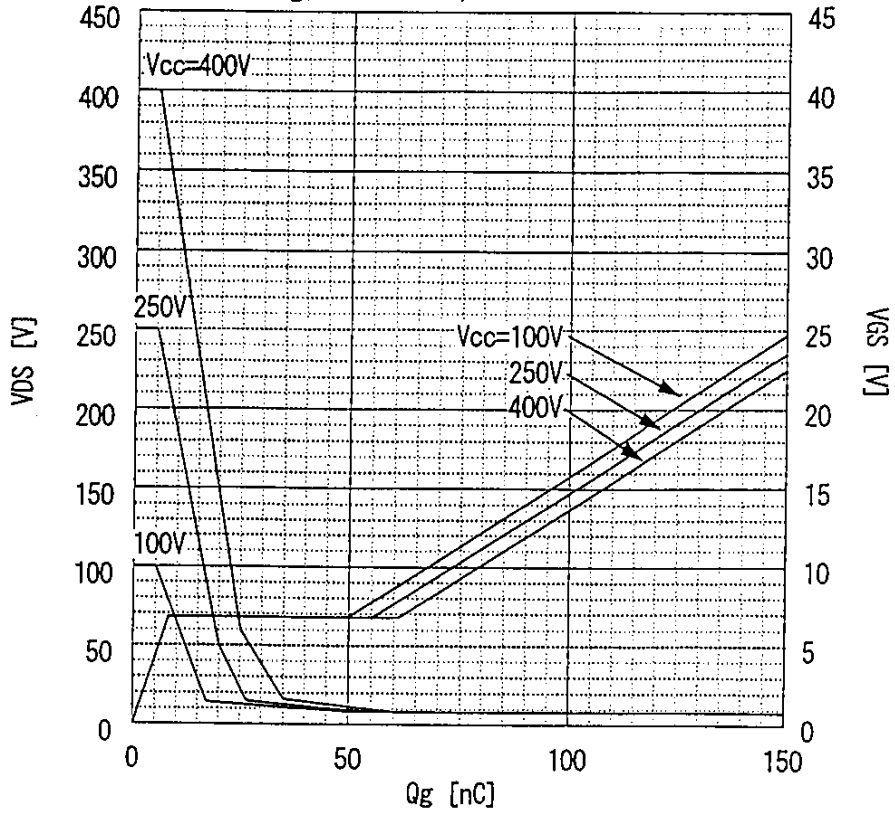

Typical capacitances
 $C = f(V_{DS}) : V_{GS} = 0V, f = 1MHz$

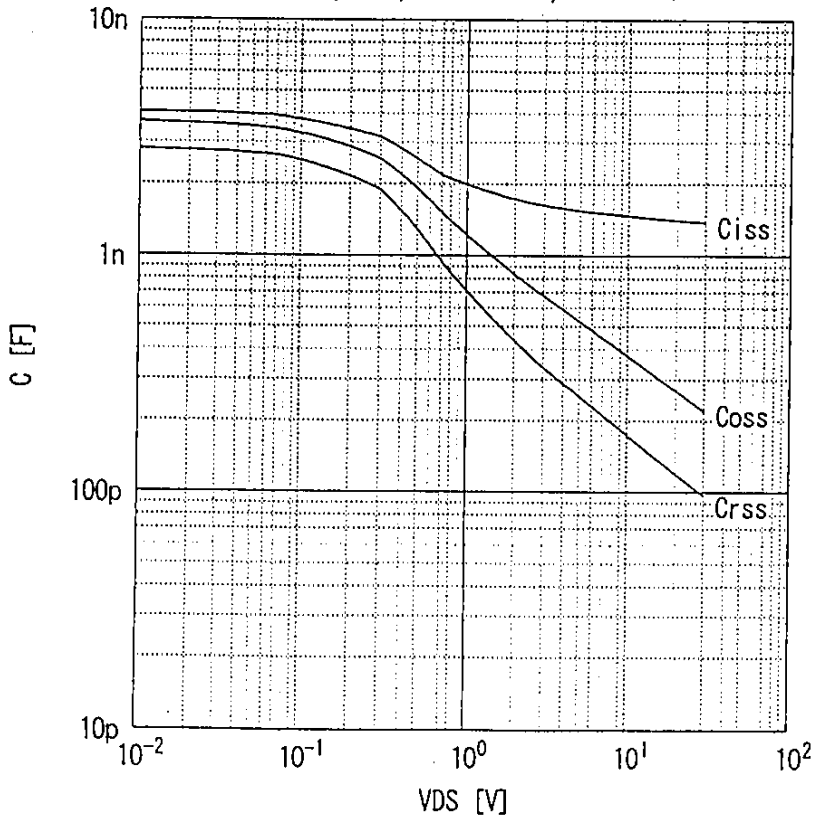

Forward characteristic of reverse of diode
 $I_F = f(V_{SD}) : 80 \mu s$ pulses test, $V_{GS} = 0V$

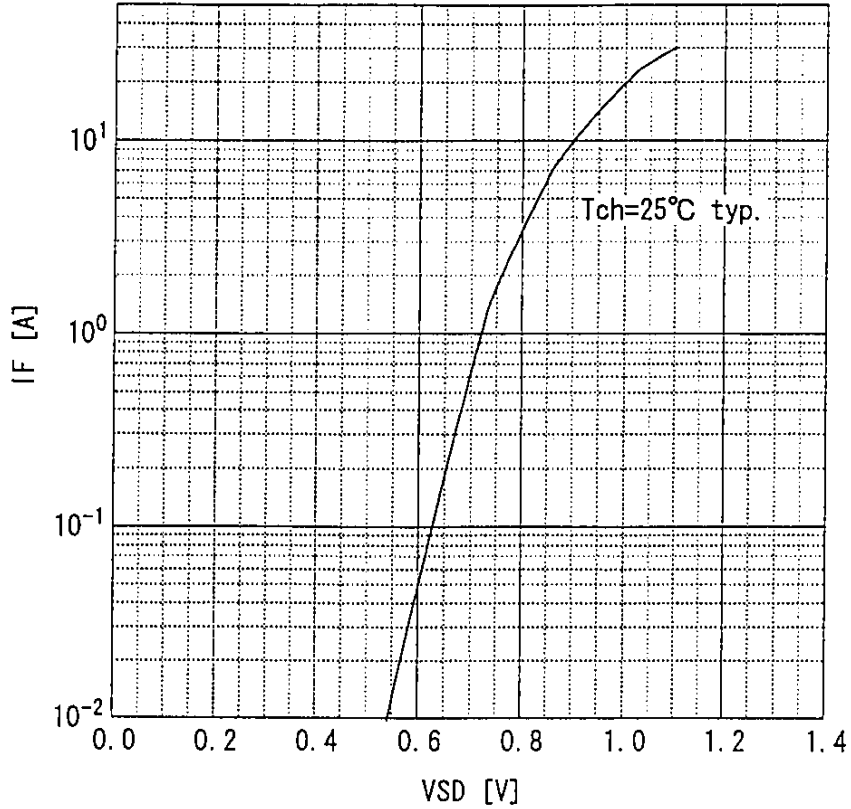

Transient thermal impedande
 $Z_{thch-c} = f(t)$ parameter: $D = t/T$

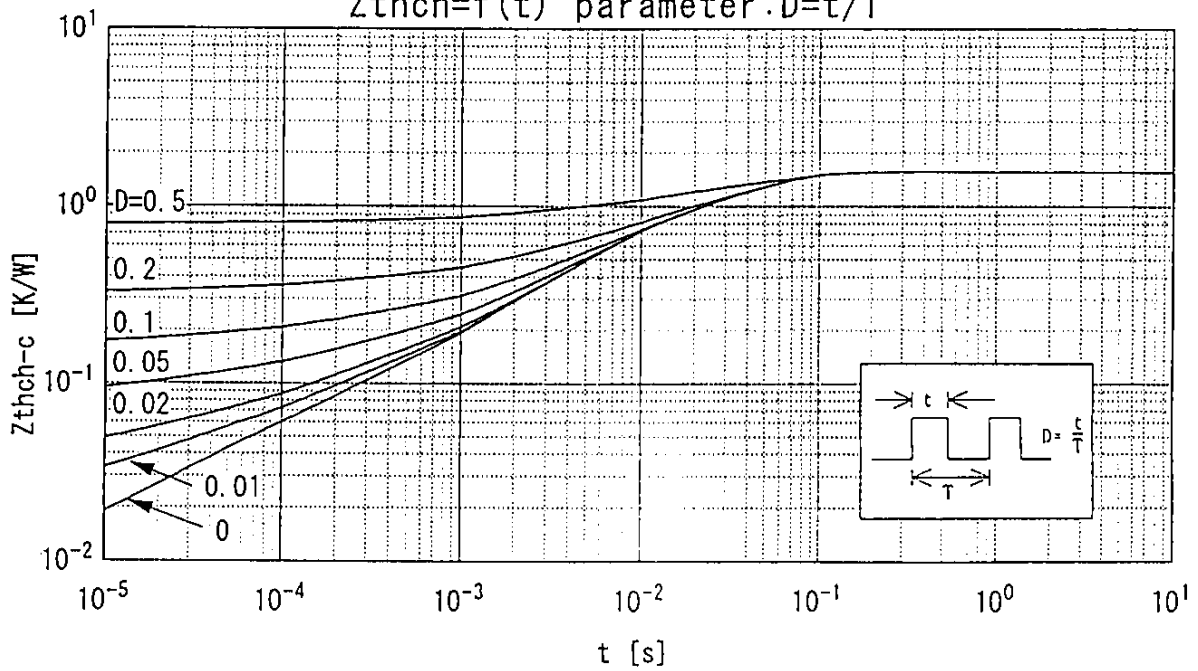

Avalanche energy derating
 $E_{as} = f(\text{starting } T_{ch}) : V_{CC} = 50V, I_{AV} = 15A$

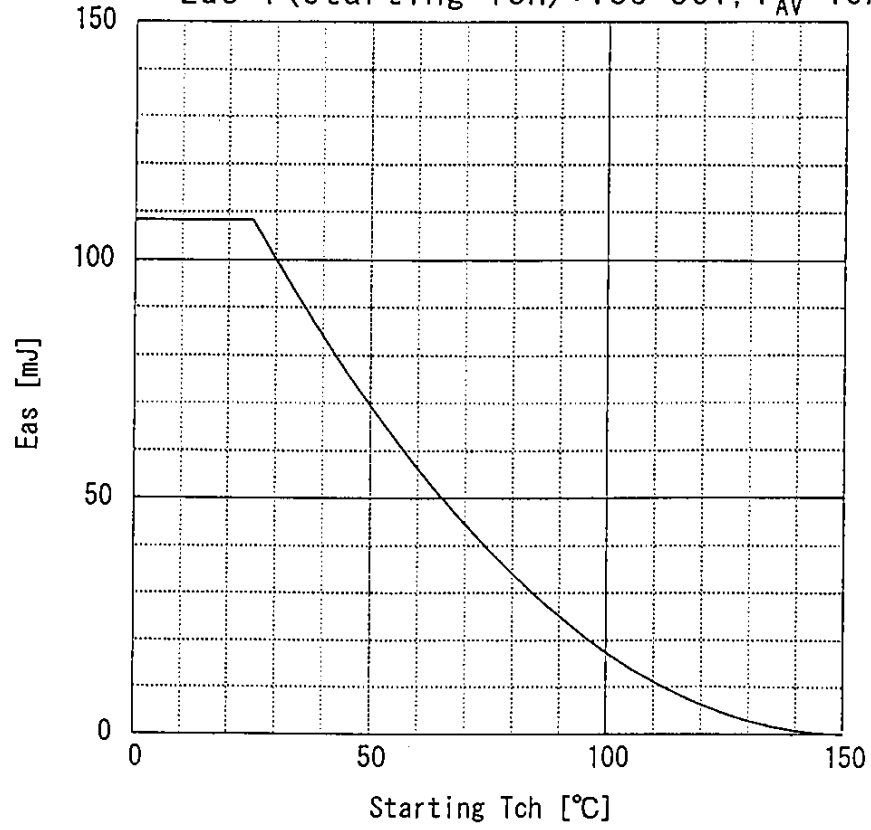

Fuji Electric Co.,Ltd.

DWG. NO.

12/12

Y 0257-R-003a