

74ACTQ16540

16-Bit Inverting Buffer/Line Driver with 3-STATE Outputs

General Description

The ACTQ16540 contains sixteen inverting buffers with 3-STATE outputs designed to be employed as a memory and address driver, clock driver, or bus-oriented transmitter/receiver. The device is byte controlled. Each byte has separate 3-STATE control inputs which can be shorted together for full 16-bit operation.

The ACTQ16540 utilizes Fairchild Quiet Series™ technology to guarantee quiet output switching and improved dynamic threshold performance. FACT Quiet Series™ features GTO™ output control for superior performance.

Features

- Utilizes Fairchild FACT Quiet Series technology
- Guaranteed simultaneous switching noise level and dynamic threshold performance
- Guaranteed pin-to-pin output skew
- Separate control logic for each byte
- Outputs source/sink 24 mA
- Additional specs for multiple output switching
- Output loading specs for both 50 pF and 250 pF loads

Ordering Code:

Order Number	Package Number	Package Description
74ACTQ16540SSC	MS48A	48-Lead Small Shrink Outline Package (SSOP), JEDEC MO-118, 0.300" Wide
74ACTQ16540MTD	MTD48	48-Lead Thin Shrink Small Outline Package (TSSOP), JEDEC MO-153, 6.1mm Wide

Device also available in Tape and Reel Specify by appending suffix letter "X" to the ordering code.

Logic Symbol

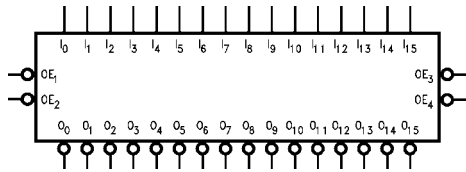

Connection Diagram

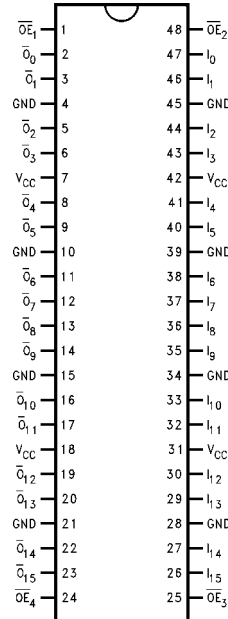

Pin Descriptions

Pin Names	Description
\overline{OE}_n	Output Enable Input (Active LOW)
I_0-I_{15}	Inputs
$\overline{O}_0-\overline{O}_{15}$	Outputs

FACT™, Quiet Series™, FACT Quiet Series™ and GTO™ are trademarks of Fairchild Semiconductor Corporation.

74ACTQ16540 16-Bit Inverting Buffer/Line Driver with 3-STATE Outputs

Functional Description

The ACTQ16540 contains sixteen inverting buffers with 3-STATE standard outputs. The device is byte controlled with each byte functioning identically, but independent of the other. The control pins may be shorted together to obtain full 16-bit operation. The 3-STATE outputs are controlled by an Output Enable (\overline{OE}_n) input for each byte. When \overline{OE}_n is LOW, the outputs are in 2-state mode. When \overline{OE}_n is HIGH, the outputs are in the high impedance mode, but this does not interfere with entering new data into the inputs.

Truth Tables

Inputs			Outputs
\overline{OE}_1	\overline{OE}_2	I_0-I_7	$\overline{O}_0-\overline{O}_7$
L	L	H	L
H	X	X	Z
X	H	X	Z
L	L	L	H

Inputs			Outputs
\overline{OE}_3	\overline{OE}_4	I_8-I_{15}	$\overline{O}_8-\overline{O}_{15}$
L	L	H	L
H	X	X	Z
X	H	X	Z
L	L	L	H

H = HIGH Voltage Level
 L = LOW Voltage Level
 X = Immaterial
 Z = High Impedance

Logic Diagram

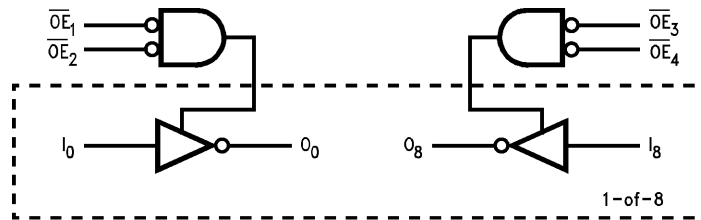

Absolute Maximum Ratings(Note 1)

Supply Voltage (V_{CC})	-0.5V to +7.0V
DC Input Diode Current (I_{IK})	
$V_I = -0.5V$	-20 mA
$V_I = V_{CC} + 0.5V$	+20 mA
DC Output Diode Current (I_{OK})	
$V_O = -0.5V$	-20 mA
$V_O = V_{CC} + 0.5V$	+20 mA
DC Output Voltage (V_O)	-0.5V to $V_{CC} + 0.5V$
DC Output Source/Sink Current (I_O)	± 50 mA
DC V_{CC} or Ground Current per Output Pin	± 50 mA
Storage Temperature	-65°C to +150°C

Recommended Operating Conditions

Supply Voltage (V_{CC})	4.5V to 5.5V
Input Voltage (V_I)	0V to V_{CC}
Output Voltage (V_O)	0V to V_{CC}
Operating Temperature (T_A)	-40°C to +85°C
Minimum Input Edge Rate ($\Delta V/\Delta t$)	125 mV/ns
V_{IN} from 0.8V to 2.0V	
V_{CC} @ 4.5V, 5.5V	

Note 1: Absolute maximum ratings are those values beyond which damage to the device may occur. The databook specifications should be met, without exception to ensure that the system design is reliable over its power supply, temperature, and output/input loading variables. Fairchild does not recommend operation of FACT™ circuits outside databook specifications.

DC Electrical Characteristics

Symbol	Parameter	V_{CC} (V)	$T_A = +25^\circ\text{C}$		$T_A = -40^\circ\text{C to } +85^\circ\text{C}$		Units	Conditions
			Typ	Guaranteed Limits				
V_{IH}	Minimum HIGH Input Voltage	4.5	1.5	2.0	2.0	V	$V_{OUT} = 0.1V$ or $V_{CC} - 0.1V$	
		5.5	1.5	2.0	2.0			
V_{IL}	Maximum LOW Input Voltage	4.5	1.5	0.8	0.8	V	$V_{OUT} = 0.1V$ or $V_{CC} - 0.1V$	
		5.5	1.5	0.8	0.8			
V_{OH}	Minimum HIGH Output Voltage	4.5	4.49	4.4	4.4	V	$I_{OUT} = -50 \mu A$	
		5.5	5.49	5.4	5.4			
		4.5		3.86	3.76	V	$V_{IN} = V_{IL}$ or V_{IH} $I_{OH} = -24$ mA $I_{OH} = -24$ mA (Note 2)	
		5.5		4.86	4.76			
V_{OL}	Maximum LOW Output Voltage	4.5	0.001	0.1	0.1	V	$I_{OUT} = 50 \mu A$	
		5.5	0.001	0.1	0.1			
		4.5		0.36	0.44	V	$V_{IN} = V_{IL}$ or V_{IH} $I_{OL} = 24$ mA $I_{OL} = 24$ mA (Note 2)	
		5.5		0.36	0.44			
I_{OZ}	Maximum 3-STATE Leakage Current	5.5		± 0.5	± 5.0	μA	$V_I = V_{IL}, V_{IH}$ $V_O = V_{CC}, GND$	
I_{IN}	Maximum Input Leakage Current	5.5		± 0.1	± 1.0	μA	$V_I = V_{CC}, GND$	
I_{CCT}	Maximum $I_{CC}/Input$	5.5	0.6		1.5	mA	$V_I = V_{CC} - 2.1V$	
I_{CC}	Max Quiescent Supply Current	5.5		8.0	80.0	μA	$V_{IN} = V_{CC}$ or GND	
I_{OLD}	Minimum Dynamic	5.5			75	mA	$V_{OLD} = 1.65V$ Max	
I_{OHD}	Output Current (Note 3)				-75	mA	$V_{OHD} = 3.85V$ Min	
V_{OLP}	Quiet Output Maximum Dynamic V_{OL}	5.0	0.5	0.8		V	Figure 1, Figure 2 (Note 5)(Note 6)	
V_{OLV}	Quiet Output Minimum Dynamic V_{OL}	5.0	-0.5	-1.0		V	Figure 1, Figure 2 (Note 5)(Note 6)	
V_{OHP}	Maximum Overshoot	5.0	$V_{OH} + 1.0$	$V_{OH} + 1.5$		V	Figure 1, Figure 2 (Note 4)(Note 6)	
V_{OHV}	Minimum V_{CC} Droop	5.0	$V_{OH} - 1.0$	$V_{OH} - 1.8$		V	Figure 1, Figure 2 (Note 4)(Note 6)	
V_{IHD}	Minimum HIGH Dynamic Input Voltage Level	5.0	1.7	2.0		V	(Note 4)(Note 7)	
V_{ILD}	Maximum LOW Dynamic Input Voltage Level	5.0	1.2	0.8		V	(Note 4)(Note 7)	

Note 2: All outputs loaded; thresholds associated with output under test.

Note 3: Maximum test duration 2.0 ms; one output loaded at a time.

Note 4: Worst case package.

Note 5: Maximum number of outputs that can switch simultaneously is n. (n - 1) outputs are switched LOW and one output held LOW.

Note 6: Maximum number of outputs that can switch simultaneously is n. (n - 1) outputs are switched HIGH and one output held HIGH.

Note 7: Maximum number of data inputs (n) switching. (n - 1) input switching 0V to 3V (ACTQ). Input under test switching 3V to threshold (V_{LD}).

AC Electrical Characteristics								
Symbol	Parameter	V _{CC} (V) (Note 8)	T _A = +25°C C _L = 50 pF			T _A = -40°C to +85°C C _L = 50 pF		Units
			Typ	Min	Max	Min	Max	
t _{PLH}	Propagation Delay	5.0	2.7	4.9	7.3	2.7	7.8	ns
t _{PHL}	Data to Output		3.0	5.1	7.3	3.0	7.8	
t _{PZH}	Output Enable	5.0	2.5	4.8	7.4	2.5	7.9	ns
t _{PZL}	Time		2.7	5.3	8.0	2.7	8.5	
t _{PHZ}	Output Disable	5.0	2.5	5.4	8.3	2.5	8.7	ns
t _{PLZ}	Time		2.3	5.0	7.4	2.3	7.9	

Note 8: Voltage Range 5.0 is 5.0V ± 0.5V.

Extended AC Electrical Characteristics								
Symbol	Parameter	V _{CC} (V) (Note 9)	T _A = -40°C to +85°C C _L = 50 pF 16 Outputs Switching (Note 10)			T _A = -40°C to +85°C C _L = 250 pF (Note 11)		Units
			Min	Typ	Max	Min	Max	
t _{PLH}	Propagation Delay,	5.0	4.0		12.6	5.6	15.5	ns
t _{PHL}	Data to Output		4.0		10.0	5.6	13.6	
t _{PZH}	Output Enable Time	5.0	3.2		10.8	(Note 12)	ns	
t _{PZL}	Time		3.4		10.8			
t _{PHZ}	Output Disable Time	5.0	3.8		9.5	(Note 13)	ns	
t _{PLZ}	Time		3.1		9.2			
t _{OSSL} (Note 14)	Pin to Pin Skew, HL Data to Output	5.0			1.2		ns	
t _{OSLH} (Note 14)	Pin to Pin Skew, LH Data to Output	5.0			2.5		ns	
t _{OST} (Note 14)	Pin to Pin Skew, LH/HL Data to Output	5.0			4.3		ns	

Note 9: Voltage Range 5.0 is 5.0V ± 0.5V.

Note 10: This specification is guaranteed but not tested. The limits apply to propagation delays for all paths described switching in phase (i.e., all LOW-to-HIGH, HIGH-to-LOW, etc.).

Note 11: This specification is guaranteed but not tested. The limits represent propagation delays with 250 pF load capacitors in place of the 50 pF load capacitors in the standard AC load. This specification pertains to single output switching only.

Note 12: 3-STATE delays are load dominated and have been excluded from the datasheet.

Note 13: The Output Disable Time is dominated by the RC network (500Ω, 250 pF) on the output and has been excluded from the datasheet.

Note 14: Skew is defined as the absolute value of the difference between the actual propagation delays for any two separate outputs of the same device. The specification applies to any outputs switching HIGH-to-LOW (t_{OSSL}), LOW-to-HIGH (t_{OSLH}), or any combination switching LOW-to-HIGH and/or HIGH-to-LOW (t_{OST}).

Capacitance

Symbol	Parameter	Typ	Units	Conditions
C _{IN}	Input Pin Capacitance	4.5	pF	V _{CC} = 5.0V
C _{PD}	Power Dissipation Capacitance	30	pF	V _{CC} = 5.0V

FACT Noise Characteristics

The setup of a noise characteristics measurement is critical to the accuracy and repeatability of the tests. The following is a brief description of the setup used to measure the noise characteristics of FACT.

Equipment:

Hewlett Packard Model 8180A Word Generator
PC-163A Test Fixture
Tektronics Model 7854 Oscilloscope

Procedure:

1. Verify Test Fixture Loading: Standard Load 50 pF, 500Ω.
2. Deskew the HFS generator so that no two channels have greater than 150 ps skew between them. This requires that the oscilloscope be deskewed first. It is important to deskew the HFS generator channels before testing. This will ensure that the outputs switch simultaneously.
3. Terminate all inputs and outputs to ensure proper loading of the outputs and that the input levels are at the correct voltage.
4. Set the HFS generator to toggle all but one output at a frequency of 1 MHz. Greater frequencies will increase DUT heating and effect the results of the measurement.
5. Set the word generator input levels at 0V LOW and 3V HIGH for ACT devices and 0V LOW and 5V HIGH for AC devices. Verify levels with an oscilloscope.

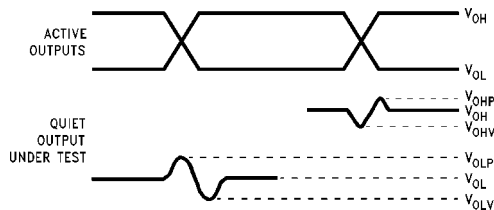

V_{OHV} and V_{OLP} are measured with respect to ground reference.

Input pulses have the following characteristics: $f = 1$ MHz, $t_r = 3$ ns, $t_f = 3$ ns, skew < 150 ps.

FIGURE 1. Quiet Output Noise Voltage Waveforms

V_{OLP}/V_{OLV} and V_{OHP}/V_{OHV} :

- Determine the quiet output pin that demonstrates the greatest noise levels. The worst case pin will usually be the furthest from the ground pin. Monitor the output voltages using a 50Ω coaxial cable plugged into a standard SMB type connector on the test fixture. Do not use an active FET probe.
- Measure V_{OLP} and V_{OLV} on the quiet output during the worst case transition for active and enable. Measure V_{OHP} and V_{OHV} on the quiet output during the worst case transition for active and enable.
- Verify that the GND reference recorded on the oscilloscope has not drifted to ensure the accuracy and repeatability of the measurements.

V_{ILD} and V_{IHD} :

- Monitor one of the switching outputs using a 50Ω coaxial cable plugged into a standard SMB type connector on the test fixture. Do not use an active FET probe.
- First increase the input LOW voltage level, V_{IL} , until the output begins to oscillate or steps out a min of 2 ns. Oscillation is defined as noise on the output LOW level that exceeds V_{IL} limits, or on output HIGH levels that exceed V_{IH} limits. The input LOW voltage level at which oscillation occurs is defined as V_{ILD} .
- Next decrease the input HIGH voltage level, V_{IH} , until the output begins to oscillate or steps out a min of 2 ns. Oscillation is defined as noise on the output LOW level that exceeds V_{IL} limits, or on output HIGH levels that exceed V_{IH} limits. The input HIGH voltage level at which oscillation occurs is defined as V_{IHD} .
- Verify that the GND reference recorded on the oscilloscope has not drifted to ensure the accuracy and repeatability of the measurements.

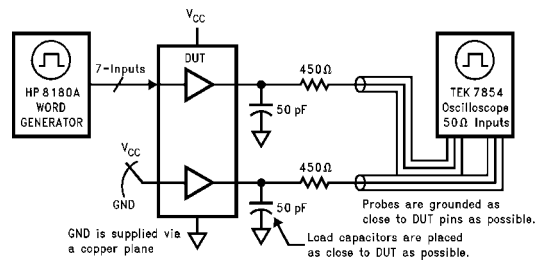
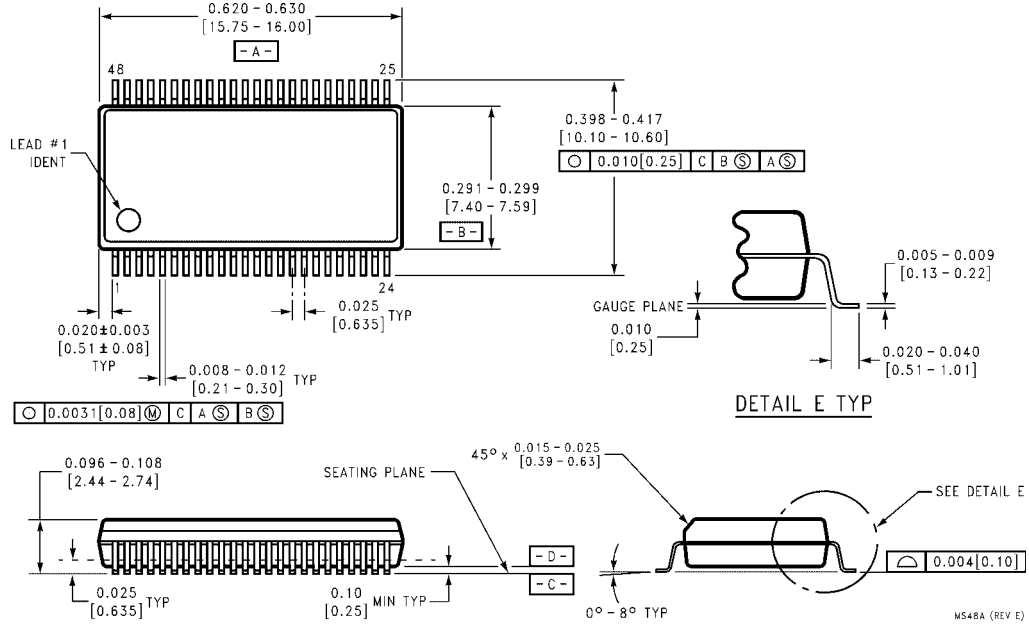

FIGURE 2. Simultaneous Switching Test Circuit

Physical Dimensions inches (millimeters) unless otherwise noted



**48-Lead Small Shrink Outline Package (SSOP), JEDEC MO-118, 0.300" Wide
Package Number MS48A**

Physical Dimensions inches (millimeters) unless otherwise noted (Continued)

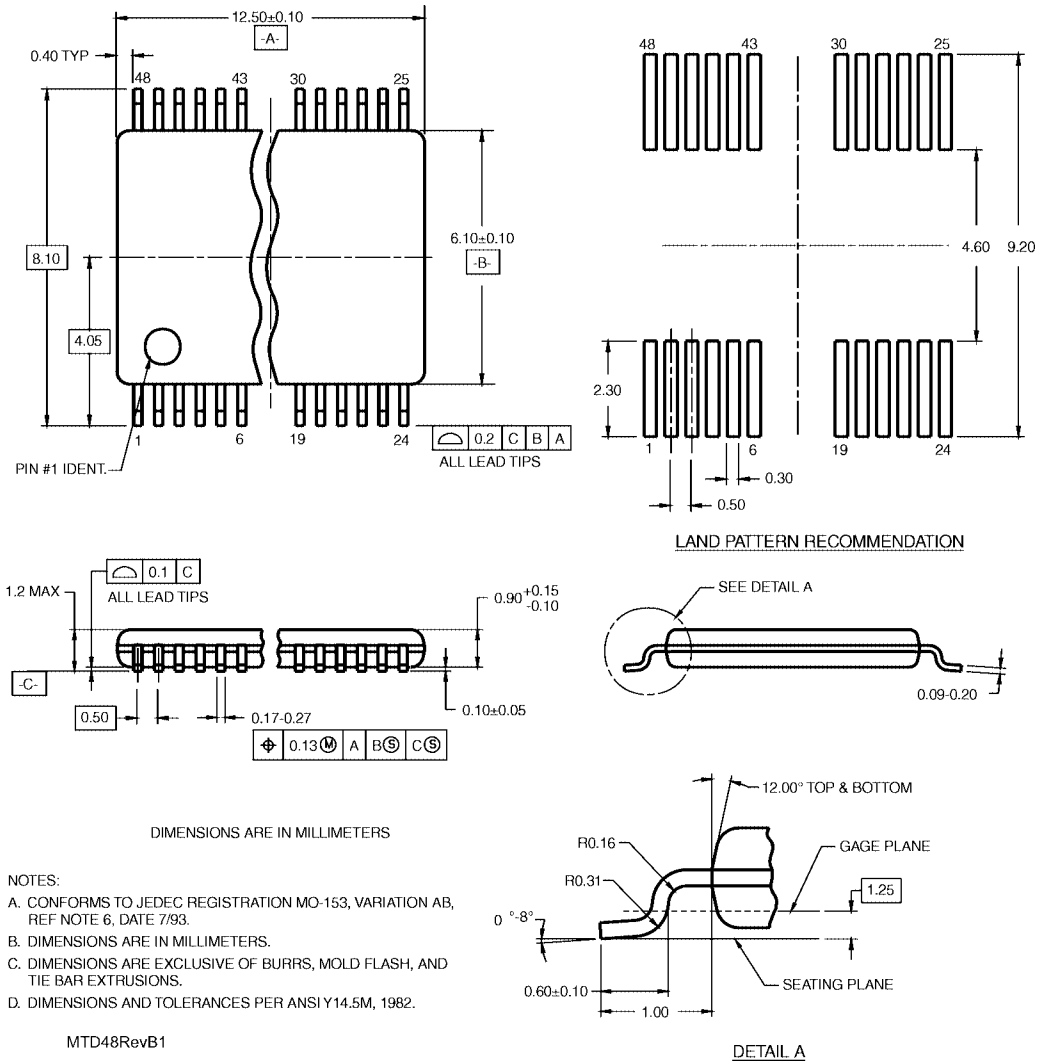

Fairchild does not assume any responsibility for use of any circuitry described, no circuit patent licenses are implied and Fairchild reserves the right at any time without notice to change said circuitry and specifications.

LIFE SUPPORT POLICY

FAIRCHILD'S PRODUCTS ARE NOT AUTHORIZED FOR USE AS CRITICAL COMPONENTS IN LIFE SUPPORT DEVICES OR SYSTEMS WITHOUT THE EXPRESS WRITTEN APPROVAL OF THE PRESIDENT OF FAIRCHILD SEMICONDUCTOR CORPORATION. As used herein:

1. Life support devices or systems are devices or systems which, (a) are intended for surgical implant into the body, or (b) support or sustain life, and (c) whose failure to perform when properly used in accordance with instructions for use provided in the labeling, can be reasonably expected to result in a significant injury to the user.
2. A critical component in any component of a life support device or system whose failure to perform can be reasonably expected to cause the failure of the life support device or system, or to affect its safety or effectiveness.

www.fairchildsemi.com