

## 74ACTQ843 Quiet Series™ 9-Bit Transparent Latch with 3-STATE Outputs

### General Description

The ACTQ843 bus interface latch is designed to eliminate the extra packages required to buffer existing latches and provide extra data width for wider address/data paths. The ACTQ843 utilizes Fairchild FACT Quiet Series™ technology to guarantee quiet output switching and improved dynamic threshold performance. FACT Quiet Series features GTO™ output control and undershoot corrector in addition to a split ground bus for superior performance.

### Features

- Guaranteed simultaneous switching noise level and dynamic threshold performance
- Guaranteed pin-to-pin skew AC performance
- Inputs and outputs on opposite sides of package for easy interface with microprocessors
- Improved latch-up immunity
- Outputs source/sink 24 mA
- ACTQ843 has TTL-compatible inputs
- Functionally and pin-compatible to AMD's AM29843
- 3-STATE outputs for bus interfacing

### Ordering Code:

Order Number	Package Number	Package Description
74ACTQ843SC	M24B	24-Lead Small Outline Integrated Circuit (SOIC), JEDEC MS-013, 0.300" Wide Body
74ACTQ843SPC	N24C	24-Lead Plastic Dual-In-Line Package (PDIP), JEDEC MS-100, 0.300" Wide

Device also available in Tape and Reel. Specify by appending suffix letter "X" to the ordering code.

### Logic Symbols

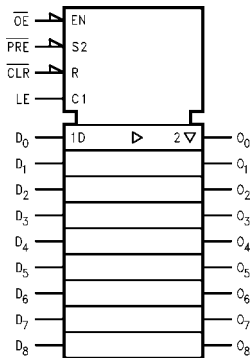
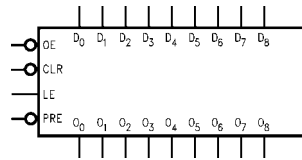

### Connection Diagram

Pin Assignment for DIP and SOIC

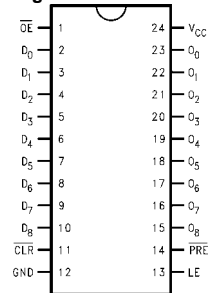

### Pin Descriptions

Pin Names	Description
D <sub>0</sub> -D <sub>8</sub>	Data Inputs
O <sub>0</sub> -O <sub>8</sub>	Data Outputs
OE	Output Enable
LE	Latch Enable
CLR	Clear
PRE	Preset

FACT™, Quiet Series™, FACT Quiet Series™ and GTO™ are trademarks of Fairchild Semiconductor Corporation.

### Functional Description

The ACTQ843 consists of nine D-type latches with 3-STATE outputs. The flip-flops appear transparent to the data when Latch Enable (LE) is HIGH. This allows asynchronous operation, as the output transition follows the data in transition. On the LE HIGH-to-LOW transition, the data that meets the setup times is latched. Data appears on the bus when the Output Enable ( $\overline{OE}$ ) is LOW. When  $\overline{OE}$  is HIGH, the bus output is in the high impedance state.

In addition to the LE and  $\overline{OE}$  pins, the ACTQ843 has a Clear ( $\overline{CLR}$ ) pin and a Preset ( $\overline{PRE}$ ) pin. These pins are ideal for parity bus interfacing in high performance systems. When  $\overline{CLR}$  is LOW, the outputs are LOW if  $\overline{OE}$  is LOW. When  $\overline{CLR}$  is HIGH, data can be entered into the latch. When  $\overline{PRE}$  is LOW, the outputs are HIGH if  $\overline{OE}$  is LOW. Preset overrides  $\overline{CLR}$ .

### Function Table

Inputs					Internal	Outputs	Function
$\overline{CLR}$	$\overline{PRE}$	$\overline{OE}$	LE	D	Q	O	
H	H	H	H	L	L	Z	High Z
H	H	H	H	H	H	Z	High Z
H	H	H	L	X	NC	Z	Latched
H	H	L	H	L	L	L	Transparent
H	H	L	H	H	H	H	Transparent
H	H	L	L	X	NC	NC	Latched
H	L	L	X	X	H	H	Preset
L	H	L	X	X	L	L	Clear
L	L	L	X	X	H	H	Preset
L	H	H	L	X	L	Z	Clear/High Z
H	L	H	L	X	H	Z	Preset/High Z

H = HIGH Voltage Level  
 L = LOW Voltage Level  
 X = Immaterial  
 Z = High Impedance  
 NC = No Change

### Logic Diagram

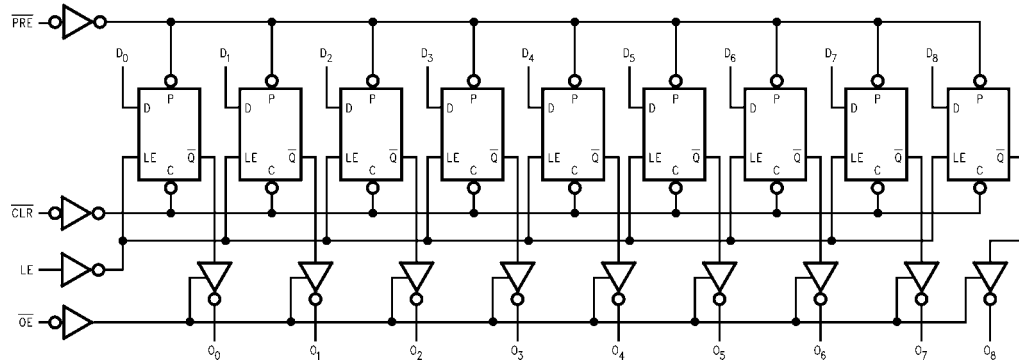

Absolute Maximum Ratings (Note 1)		Junction Temperature ( $T_J$ )	
Supply Voltage ( $V_{CC}$ )	-0.5V to +7.0V	PDIP	140°C
DC Input Diode Current ( $I_{IK}$ )		<b>Recommended Operating Conditions</b>	
$V_I = -0.5V$	-20 mA	Supply Voltage ( $V_{CC}$ )	4.5V to 5.5V
$V_I = V_{CC} + 0.5V$	+20 mA	Input Voltage ( $V_I$ )	0V to $V_{CC}$
DC Input Voltage ( $V_I$ )	-0.5V to $V_{CC} + 0.5V$	Output Voltage ( $V_O$ )	0V to $V_{CC}$
DC Output Diode Current ( $I_{OK}$ )		Operating Temperature ( $T_A$ )	-40°C to +85°C
$V_O = -0.5V$	-20 mA	Minimum Input Edge Rate $\Delta V/\Delta t$	125 mV/ns
$V_O = V_{CC} + 0.5V$	+20 mA	$V_{IN}$ from 0.8V to 2.0V	
DC Output Voltage ( $V_O$ )	-0.5V to $V_{CC} + 0.5V$	$V_{CC}$ @ 4.5V, 5.5V	
DC Output Source		<b>Note 1:</b> Absolute maximum ratings are those values beyond which damage to the device may occur. The databook specifications should be met, without exception, to ensure that the system design is reliable over its power supply, temperature, and output/input loading variables. Fairchild does not recommend operation of FACT™ circuits outside databook specifications.	
or Sink Current ( $I_O$ )	±50 mA		
DC $V_{CC}$ or Ground Current			
per Output Pin ( $I_{CC}$ or $I_{GND}$ )	±50 mA		
Storage Temperature ( $T_{STG}$ )	-65°C to +150°C		
DC Latch-Up Source			
or Sink Current	±300 mA		

## DC Electrical Characteristics

Symbol	Parameter	$V_{CC}$ (V)	$T_A = +25^\circ\text{C}$		$T_A = -40^\circ\text{C to } +85^\circ\text{C}$		Units	Conditions
			Typ	Guaranteed Limits				
$V_{IH}$	Minimum HIGH Level Input Voltage	4.5	1.5	2.0	2.0	V	$V_{OUT} = 0.1V$ or $V_{CC} - 0.1V$	
		5.5	1.5	2.0	2.0			
$V_{IL}$	Maximum LOW Level Input Voltage	4.5	1.5	0.8	0.8	V	$V_{OUT} = 0.1V$ or $V_{CC} - 0.1V$	
		5.5	1.5	0.8	0.8			
$V_{OH}$	Minimum HIGH Level Output Voltage	4.5	4.49	4.4	4.4	V	$I_{OUT} = -50 \mu A$	
		5.5	5.49	5.4	5.4			
		4.5		3.86	3.76			V
5.5		4.86	4.76					
$V_{OL}$	Maximum LOW Level Output Voltage	4.5	0.001	0.1	0.1	V	$I_{OUT} = 50 \mu A$	
		5.5	0.001	0.1	0.1			
		4.5		0.36	0.44			V
5.5		0.36	0.44					
$I_{IN}$	Maximum Input Leakage Current	5.5		±0.1	±1.0	μA	$V_I = V_{CC}, GND$	
$I_{OZ}$	Maximum 3-STATE Leakage Current	5.5		±0.5	±5.0	μA	$V_I = V_{IL}, V_{IH}$ $V_O = V_{CC}, GND$	
$I_{CCT}$	Maximum $I_{CC}$ /Input	5.5	0.6		1.5	mA	$V_I = V_{CC} - 2.1V$	
$I_{OLD}$	Minimum Dynamic	5.5			75	mA	$V_{OLD} = 1.65V$ Max	
$I_{OHD}$	Output Current (Note 3)	5.5			-75	mA	$V_{OHD} = 3.85V$ Min	
$I_{CC}$	Maximum Quiescent Supply Current	5.5		8.0	80.0	μA	$V_{IN} = V_{CC}$ or GND	
$V_{OLP}$	Quiet Output Maximum Dynamic $V_{OL}$	5.0	1.1	1.5		V	Figure 1, Figure 2 (Note 4)(Note 5)	
$V_{OLV}$	Quiet Output Minimum Dynamic $V_{OL}$	5.0	-0.6	-1.2		V	Figure 1, Figure 2 (Note 4)(Note 5)	
$V_{IHD}$	Minimum HIGH Level Dynamic Input Voltage	5.0	1.9	2.0		V	(Note 4)(Note 6)	
$V_{ILD}$	Maximum LOW Level Dynamic Input Voltage	5.0	1.2	0.8		V	(Note 4)(Note 6)	

**DC Electrical Characteristics** (Continued)

**Note 2:** All outputs loaded; thresholds on input associated with output under test.

**Note 3:** Maximum test duration 2.0 ms, one output loaded at a time.

**Note 4:** DIP package.

**Note 5:** Max number of outputs defined as (n). Data inputs are driven 0V to 3V. One output @ GND.

**Note 6:** Max number of data inputs (n) switching. (n - 1) inputs switching 0V to 3V. Input-under-test switching: 3V to threshold ( $V_{ILD}$ ), 0V to threshold ( $V_{IHD}$ ),  $f = 1$  MHz.

**AC Electrical Characteristics**

Symbol	Parameter	V <sub>CC</sub> (V) (Note 7)	T <sub>A</sub> = +25°C C <sub>L</sub> = 50 pF			T <sub>A</sub> = -40°C to +85°C C <sub>L</sub> = 50 pF		Units
			Min	Typ	Max	Min	Max	
t <sub>PLH</sub>	Propagation Delay D <sub>n</sub> to O <sub>n</sub>	5.0	2.5	6.2	9.5	2.0	10.0	ns
t <sub>PHL</sub>	Propagation Delay D <sub>n</sub> to O <sub>n</sub>	5.0	2.5	6.7	9.5	2.0	10.0	ns
t <sub>PLH</sub>	Propagation Delay LE to O <sub>n</sub>	5.0	2.5	7.1	9.0	2.0	10.0	ns
t <sub>PHL</sub>	Propagation Delay LE to O <sub>n</sub>	5.0	2.5	6.9	9.0	2.0	10.0	ns
t <sub>PLH</sub>	Propagation Delay $\overline{\text{PRE}}$ to O <sub>n</sub>	5.0	2.5	7.3	10.0	2.0	11.0	ns
t <sub>PHL</sub>	Propagation Delay $\overline{\text{CLR}}$ to O <sub>n</sub>	5.0	2.5	7.2	11.0	2.0	12.0	ns
t <sub>PZH</sub>	Output Enable Time $\overline{\text{OE}}$ to O <sub>n</sub>	5.0	2.5	7.2	9.5	2.0	10.5	ns
t <sub>PZL</sub>	Output Enable Time $\overline{\text{OE}}$ to O <sub>n</sub>	5.0	2.5	7.5	9.5	2.0	10.5	ns
t <sub>PHZ</sub>	Output Disable Time $\overline{\text{OE}}$ to O <sub>n</sub>	5.0	1.5	5.0	8.0	1.0	8.5	ns
t <sub>PLZ</sub>	Output Disable Time $\overline{\text{OE}}$ to O <sub>n</sub>	5.0	1.5	5.1	8.0	1.0	8.5	ns
t <sub>PHL</sub>	Propagation Delay $\overline{\text{PRE}}$ to O <sub>n</sub>	5.0	2.5	6.7	10.0	2.0	11.0	ns
t <sub>PLH</sub>	Propagation Delay $\overline{\text{CLR}}$ to O <sub>n</sub>	5.0	2.5	7.3	11.0	2.0	12.0	ns
t <sub>OSLH</sub> t <sub>OSHL</sub>	Output to Output Skew (Note 8) D <sub>n</sub> to O <sub>n</sub>	5.0		0.5	1.5		1.5	ns

**Note 7:** Voltage Range 5.0 is 5.0V ±0.5V.

**Note 8:** Skew is defined as the absolute value of the difference between the actual propagation delay for any two outputs within the same packaged device. The specification applies to any outputs switching in the same direction, either HIGH to LOW (t<sub>OSHL</sub>) or LOW to HIGH (t<sub>OSLH</sub>). Parameter guaranteed by design. Not tested.

## AC Operating Requirements

Symbol	Parameter	V <sub>CC</sub> (V) (Note 9)	T <sub>A</sub> = +25°C	T <sub>A</sub> = -40°C to +85°C		Units
			C <sub>L</sub> = 50 pF	C <sub>L</sub> = 50 pF		
			Typ	Guaranteed Minimum		
t <sub>S</sub>	Setup Time, HIGH or LOW D <sub>n</sub> to LE	5.0		3.0	3.0	ns
t <sub>H</sub>	Hold Time, HIGH or LOW D <sub>n</sub> to LE	5.0		1.5	1.5	ns
t <sub>W</sub>	LE Pulse Width, HIGH	5.0		4.0	4.0	ns
t <sub>W</sub>	PRE Pulse Width, LOW	5.0		4.0	4.0	ns
t <sub>W</sub>	CLR Pulse Width, LOW	5.0		4.0	4.0	ns
t <sub>rec</sub>	PRE Recovery Time	5.0		2.0	2.0	ns
t <sub>rec</sub>	CLR Recovery Time	5.0		2.0	2.0	ns

**Note 9:** Voltage Range 5.0 is 5.0V ±0.5V.

## Capacitance

Symbol	Parameter	Typ	Units	Conditions
C <sub>IN</sub>	Input Capacitance	4.5	pF	V <sub>CC</sub> = OPEN
C <sub>PD</sub>	Power Dissipation Capacitance	52	pF	V <sub>CC</sub> = 5.0V

## FACT Noise Characteristics

The setup of a noise characteristics measurement is critical to the accuracy and repeatability of the tests. The following is a brief description of the setup used to measure the noise characteristics of FACT.

### Equipment:

Hewlett Packard Model 8180A Word Generator  
PC-163A Test Fixture  
Tektronics Model 7854 Oscilloscope

### Procedure:

1. Verify Test Fixture Loading: Standard Load 50 pF, 500Ω.
2. Deskew the HFS generator so that no two channels have greater than 150 ps skew between them. This requires that the oscilloscope be deskewed first. It is important to deskew the HFS generator channels before testing. This will ensure that the outputs switch simultaneously.
3. Terminate all inputs and outputs to ensure proper loading of the outputs and that the input levels are at the correct voltage.
4. Set the HFS generator to toggle all but one output at a frequency of 1 MHz. Greater frequencies will increase DUT heating and effect the results of the measurement.
5. Set the HFS generator input levels at 0V LOW and 3V HIGH for ACT devices and 0V LOW and 5V HIGH for AC devices. Verify levels with an oscilloscope.

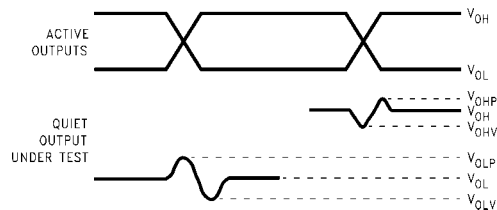

**FIGURE 1. Quiet Output Noise Voltage Waveforms**

**Note 10:**  $V_{OHV}$  and  $V_{OLP}$  are measured with respect to ground reference.

**Note 11:** Input pulses have the following characteristics:  $f = 1$  MHz,  $t_r = 3$  ns,  $t_f = 3$  ns, skew < 150 ps.

$V_{OLP}/V_{OLV}$  and  $V_{OHP}/V_{OHV}$ :

- Determine the quiet output pin that demonstrates the greatest noise levels. The worst case pin will usually be the furthest from the ground pin. Monitor the output voltages using a 50Ω coaxial cable plugged into a standard SMB type connector on the test fixture. Do not use an active FET probe.
- Measure  $V_{OLP}$  and  $V_{OLV}$  on the quiet output during the worst case transition for active and enable. Measure  $V_{OHP}$  and  $V_{OHV}$  on the quiet output during the worst case active and enable transition.
- Verify that the GND reference recorded on the oscilloscope has not drifted to ensure the accuracy and repeatability of the measurements.

$V_{ILD}$  and  $V_{IHD}$ :

- Monitor one of the switching outputs using a 50Ω coaxial cable plugged into a standard SMB type connector on the test fixture. Do not use an active FET probe.
- First increase the input LOW voltage level,  $V_{IL}$ , until the output begins to oscillate or steps out a min of 2 ns. Oscillation is defined as noise on the output LOW level that exceeds  $V_{IL}$  limits, or on output HIGH levels that exceed  $V_{IH}$  limits. The input LOW voltage level at which oscillation occurs is defined as  $V_{ILD}$ .
- Next decrease the input HIGH voltage level on the,  $V_{IH}$ , until the output begins to oscillate or steps out a min of 2 ns. Oscillation is defined as noise on the output LOW level that exceeds  $V_{IL}$  limits, or on output HIGH levels that exceed  $V_{IH}$  limits. The input HIGH voltage level at which oscillation occurs is defined as  $V_{IHD}$ .
- Verify that the GND reference recorded on the oscilloscope has not drifted to ensure the accuracy and repeatability of the measurements.

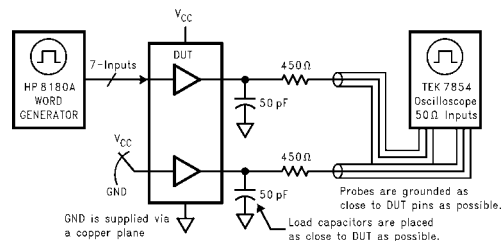

**FIGURE 2. Simultaneous Switching Test Circuit**

**Physical Dimensions** inches (millimeters) unless otherwise noted

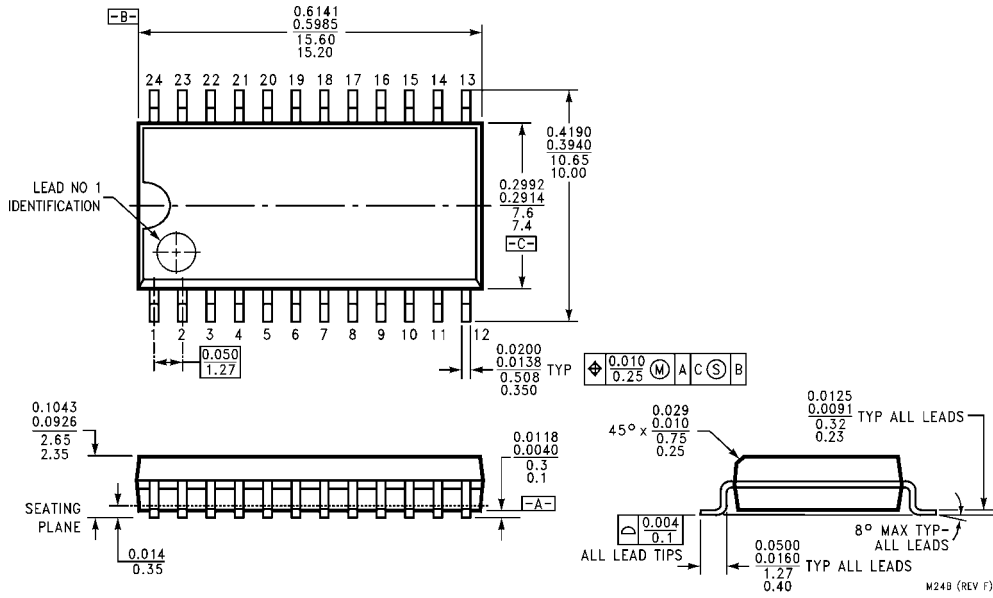

**24-Lead Small Outline Integrated Circuit (SOIC), JEDEC MS-013, 0.300" Wide Body  
Package Number M24B**

**Physical Dimensions** inches (millimeters) unless otherwise noted (Continued)

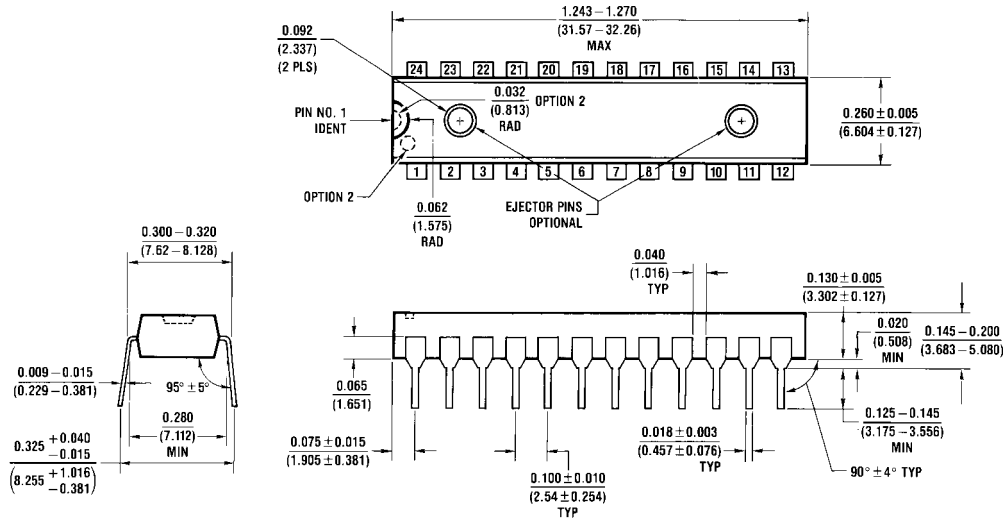

N24C (REV F)

**24-Lead Plastic Dual-In-Line Package (PDIP), JEDEC MS-100, 0.300" Wide  
 Package Number N24C**

**LIFE SUPPORT POLICY**

FAIRCHILD'S PRODUCTS ARE NOT AUTHORIZED FOR USE AS CRITICAL COMPONENTS IN LIFE SUPPORT DEVICES OR SYSTEMS WITHOUT THE EXPRESS WRITTEN APPROVAL OF THE PRESIDENT OF FAIRCHILD SEMICONDUCTOR CORPORATION. As used herein:

1. Life support devices or systems are devices or systems which, (a) are intended for surgical implant into the body, or (b) support or sustain life, and (c) whose failure to perform when properly used in accordance with instructions for use provided in the labeling, can be reasonably expected to result in a significant injury to the user.
2. A critical component in any component of a life support device or system whose failure to perform can be reasonably expected to cause the failure of the life support device or system, or to affect its safety or effectiveness.

[www.fairchildsemi.com](http://www.fairchildsemi.com)