

74LCX138

Low Voltage 1-of-8 Decoder/Demultiplexer with 5V Tolerant Inputs

General Description

The LCX138 is a high-speed 1-of-8 decoder/demultiplexer. This device is ideally suited for high-speed memory chip select address decoding. The multiple input enables allow parallel expansion to a 1-of-24 decoder using just three LCX138 devices or a 1-of-32 decoder using four LCX138 devices and one inverter.

The 74LCX138 is fabricated with advanced CMOS technology to achieve high speed operation while maintaining CMOS low power dissipation.

Features

- 5V tolerant inputs
- 2.3V–3.6V V_{CC} specifications provided
- 6.0 ns t_{PD} max ($V_{CC} = 3.3V$), 10 μA I_{CC} max
- Power down high impedance inputs and outputs
- ± 24 mA output drive ($V_{CC} = 3.0V$)
- Implements patented noise/EMI reduction circuitry
- Latch-up performance exceeds 500 mA
- ESD performance:
 - Human body model > 2000V
 - Machine model > 200V

Ordering Code:

Order Number	Package Number	Package Description
74LCX138M	M16A	16-Lead Small Outline Integrated Circuit (SOIC), JEDEC MS-012, 0.150" Narrow
74LCX138SJ	M16D	16-Lead Small Outline Package (SOP), EIAJ TYPE II, 5.3mm Wide
74LCX138MTC	MTC16	16-Lead Thin Shrink Small Outline Package (TSSOP), JEDEC MO-153, 4.4mm Wide

Devices also available in Tape and Reel. Specify by appending suffix letter "X" to the ordering code.

Connection Diagram

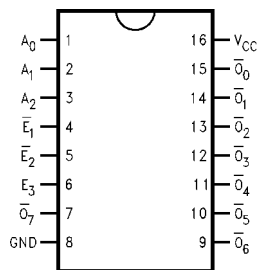

Pin Descriptions

Pin Names	Description
A_0 – A_2	Address Inputs
\bar{E}_1 – \bar{E}_2	Enable Inputs
E_3	Enable Input
\bar{O}_0 – \bar{O}_7	Outputs

Functional Description

The LCX138 high-speed 1-of-8 decoder/demultiplexer accepts three binary weighted inputs (A_0, A_1, A_2) and, when enabled, provides eight mutually exclusive active-LOW outputs ($\bar{O}_0-\bar{O}_7$). The LCX138 features three Enable inputs, two active-LOW (\bar{E}_1, \bar{E}_2) and one active-HIGH (E_3).

All outputs will be HIGH unless \bar{E}_1 and \bar{E}_2 are LOW and E_3 is HIGH. The LCX138 can be used as an 8-output demultiplexer by using one of the active LOW Enable inputs as the data input and the other Enable inputs as strobes. The Enable inputs which are not used must be permanently tied to their appropriate active-HIGH or active-LOW state.

Truth Table

Inputs						Outputs							
\bar{E}_1	\bar{E}_2	E_3	A_0	A_1	A_2	\bar{O}_0	\bar{O}_1	\bar{O}_2	\bar{O}_3	\bar{O}_4	\bar{O}_5	\bar{O}_6	\bar{O}_7
H	X	X	X	X	X	H	H	H	H	H	H	H	H
X	H	X	X	X	X	H	H	H	H	H	H	H	H
X	X	L	X	X	X	H	H	H	H	H	H	H	H
L	L	H	L	L	L	L	H	H	H	H	H	H	H
L	L	H	H	L	L	H	L	H	H	H	H	H	H
L	L	H	L	H	L	H	H	L	H	H	H	H	H
L	L	H	H	H	L	H	H	H	L	H	H	H	H
L	L	H	L	L	H	H	H	H	H	L	H	H	H
L	L	H	H	L	H	H	H	H	H	H	L	H	H
L	L	H	L	H	H	H	H	H	H	H	H	L	H
L	L	H	H	H	H	H	H	H	H	H	H	H	L

H = HIGH Voltage Level
 L = LOW Voltage Level
 X = Immaterial

Logic Diagram

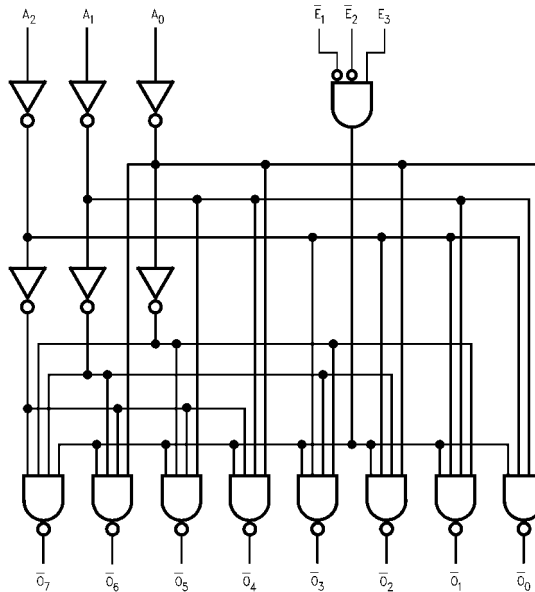

Please note that this diagram is provided only for the understanding of logic operations and should not be used to estimate propagation delays.

Absolute Maximum Ratings (Note 1)					
Symbol	Parameter	Value	Conditions	Units	
V_{CC}	Supply Voltage	-0.5 to +7.0		V	
V_I	DC Input Voltage	-0.5 to +7.0		V	
V_O	DC Output Voltage	-0.5 to $V_{CC} + 0.5$	Output in HIGH or LOW State (Note 2)	V	
I_{IK}	DC Input Diode Current	-50	$V_I < GND$	mA	
I_{OK}	DC Output Diode Current	-50	$V_O < GND$	mA	
		+50	$V_O > V_{CC}$		
I_O	DC Output Source/Sink Current	± 50		mA	
I_{CC}	DC Supply Current per Supply Pin	± 100		mA	
I_{GND}	DC Ground Current per Ground Pin	± 100		mA	
T_{STG}	Storage Temperature	-65 to +150		°C	

Recommended Operating Conditions (Note 3)					
Symbol	Parameter	Min	Max	Units	
V_{CC}	Supply Voltage	Operating	2.0	3.6	V
		Data Retention	1.5	3.6	
V_I	Input Voltage	0	5.5	V	
V_O	Output Voltage	0	V_{CC}	V	
I_{OH}/I_{OL}	Output Current	$V_{CC} = 3.0V - 3.6V$		± 24	mA
		$V_{CC} = 2.7V - 3.0V$		± 12	
		$V_{CC} = 2.3V - 2.7V$		± 8	
T_A	Free-Air Operating Temperature	-40	85	°C	
$\Delta t/\Delta V$	Input Edge Rate, $V_{IN} = 0.8V - 2.0V$, $V_{CC} = 3.0V$	0	10	ns/V	

Note 1: The Absolute Maximum Ratings are those values beyond which the safety of the device cannot be guaranteed. The device should not be operated at these limits. The parametric values defined in the Electrical Characteristics tables are not guaranteed at the Absolute Maximum Ratings. The "Recommended Operating Conditions" table will define the conditions for actual device operation.

Note 2: I_O Absolute Maximum Rating must be observed.

Note 3: Unused inputs must be held HIGH or LOW. They may not float.

DC Electrical Characteristics

Symbol	Parameter	Conditions	V_{CC} (V)	$T_A = -40^\circ C \text{ to } +85^\circ C$		Units
				Min	Max	
V_{IH}	HIGH Level Input Voltage		2.3 - 2.7	1.7		V
			2.7 - 3.6	2.0		
V_{IL}	LOW Level Input Voltage		2.3 - 2.7		0.7	V
			2.7 - 3.6		0.8	
V_{OH}	HIGH Level Output Voltage	$I_{OH} = -100 \mu A$	2.3 - 3.6	$V_{CC} - 0.2$		V
		$I_{OH} = -8 \text{ mA}$	2.3	1.8		
		$I_{OH} = -12 \text{ mA}$	2.7	2.2		
		$I_{OH} = -18 \text{ mA}$	3.0	2.4		
		$I_{OH} = -24 \text{ mA}$	3.0	2.2		
V_{OL}	LOW Level Output Voltage	$I_{OL} = 100 \mu A$	2.3 - 3.6		0.2	V
		$I_{OL} = 8 \text{ mA}$	2.3		0.6	
		$I_{OL} = 12 \text{ mA}$	2.7		0.4	
		$I_{OL} = 16 \text{ mA}$	3.0		0.4	
		$I_{OL} = 24 \text{ mA}$	3.0		0.55	
I_I	Input Leakage Current	$0 \leq V_I \leq 5.5V$	2.3 - 3.6		± 5.0	μA
I_{OFF}	Power-Off Leakage Current	$V_I \text{ or } V_O = 5.5V$	0		10	μA
I_{CC}	Quiescent Supply Current	$V_I = V_{CC} \text{ or } GND$	2.3 - 3.6		10	μA
		$3.6V \leq V_I \leq 5.5V$	2.3 - 3.6		± 10	
ΔI_{CC}	Increase in I_{CC} per Input	$V_{IH} = V_{CC} - 0.6V$	2.3 - 3.6		500	μA

AC Electrical Characteristics

Symbol	Parameter	$T_A = -40^\circ\text{C to } +85^\circ\text{C}, R_L = 500\Omega$						Units
		$V_{CC} = 3.3V \pm 0.3V$		$V_{CC} = 2.7V$		$V_{CC} = 2.5V \pm 0.2V$		
		$C_L = 50\text{pF}$		$C_L = 50\text{pF}$		$C_L = 30\text{pF}$		
		Min	Max	Min	Max	Min	Max	
$t_{PHL}t_{PLH}$	Propagation Delay	1.5	6.0	1.5	7.0	1.5	7.2	ns
	A_n to $\overline{Q_n}$	1.5	6.0	1.5	7.0	1.5	7.2	
t_{PHL} t_{PLH}	Propagation Delay	1.5	6.5	1.5	7.5	1.5	8.4	ns
	E3 to $\overline{Q_n}$	1.5	6.5	1.5	7.5	1.5	8.4	
t_{PHL} t_{PLH}	Propagation Delay	1.5	6.0	1.5	7.0	1.5	7.2	ns
	$\overline{E1}$ or $\overline{E2}$ to $\overline{Q_n}$	1.5	6.0	1.5	7.0	1.5	7.2	
t_{OSHL} t_{OSLH}	Output to Output Skew (Note 4)		1.0					ns

Note 4: Skew is defined as the absolute value of the difference between the actual propagation delay for any two separate outputs of the same device. The specification applies to any outputs switching in the same direction, either HIGH-to-LOW (t_{OSHL}) or LOW-to-HIGH (t_{OSLH}).

Dynamic Switching Characteristics

Symbol	Parameter	Conditions	V_{CC} (V)	$T_A = 25^\circ\text{C}$	Units
				Typical	
V_{OLP}	Quiet Output Dynamic Peak V_{OL}	$C_L = 50\text{ pF}, V_{IH} = 3.3V, V_{IL} = 0V$ $C_L = 30\text{ pF}, V_{IH} = 2.5V, V_{IL} = 0V$	3.3 2.5	0.8 0.6	V
V_{OLV}	Quiet Output Dynamic Valley V_{OL}	$C_L = 50\text{ pF}, V_{IH} = 3.3V, V_{IL} = 0V$ $C_L = 30\text{ pF}, V_{IH} = 2.5V, V_{IL} = 0V$	3.3 2.5	-0.8 -0.6	V

Capacitance

Symbol	Parameter	Conditions	Typical	Units
C_{IN}	Input Capacitance	$V_{CC} = \text{Open}, V_I = 0V \text{ or } V_{CC}$	7	pF
C_{OUT}	Output Capacitance	$V_{CC} = 3.3V, V_I = 0V \text{ or } V_{CC}$	8	pF
C_{PD}	Power Dissipation Capacitance	$V_{CC} = 3.3V, V_I = 0V \text{ or } V_{CC}, f = 10\text{ MHz}$	25	pF

AC Loading and Waveforms Generic for LCX Family

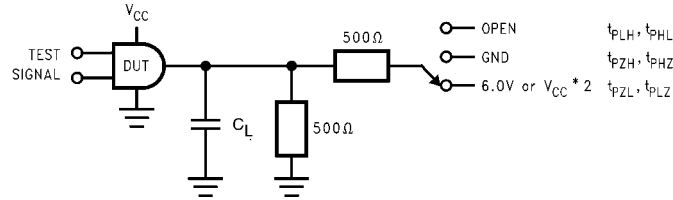
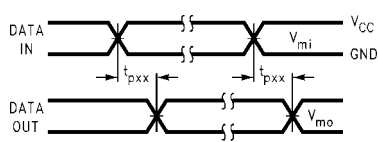
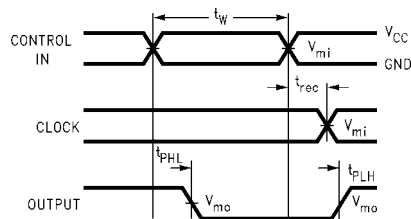

FIGURE 1. AC Test Circuit
(C_L includes probe and jig capacitance)

Test	Switch
t_{PLH}, t_{PHL}	Open
t_{PZL}, t_{PLZ}	6V at $V_{CC} = 3.3 \pm 0.3V$ $V_{CC} \times 2$ at $V_{CC} = 2.5 \pm 0.2V$
t_{PZH}, t_{PHZ}	GND



Waveform for Inverting and Non-Inverting Functions



Propagation Delay, Pulse Width and t_{rec} Waveforms

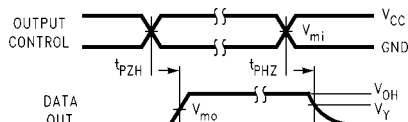

3-STATE Output High Enable and Disable Times for Logic

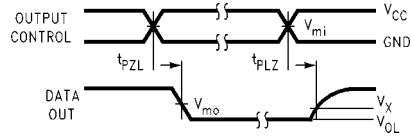

3-STATE Output Low Enable and Disable Times for Logic

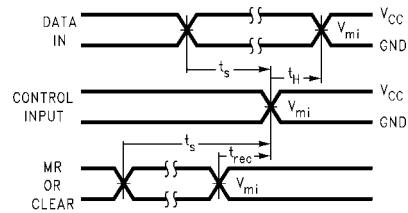

Setup Time, Hold Time and Recovery Time for Logic

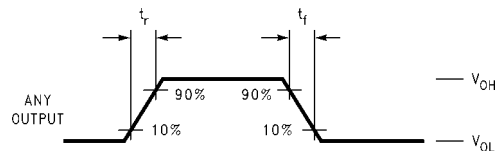

t_{rise} and t_{fall}

Symbol	V_{CC}		
	$3.3V \pm 0.3V$	2.7V	$2.5V \pm 0.2V$
V_{mi}	1.5V	1.5V	$V_{CC}/2$
V_{mo}	1.5V	1.5V	$V_{CC}/2$
V_x	$V_{OL} + 0.3V$	$V_{OL} + 0.3V$	$V_{OL} + 0.15V$
V_y	$V_{OH} - 0.3V$	$V_{OH} - 0.3V$	$V_{OH} - 0.15V$

FIGURE 2. Waveforms
(Input Pulse Characteristics; $f=1MHz, t_r=t_f=3ns$)

Schematic Diagram Generic for LCX Family

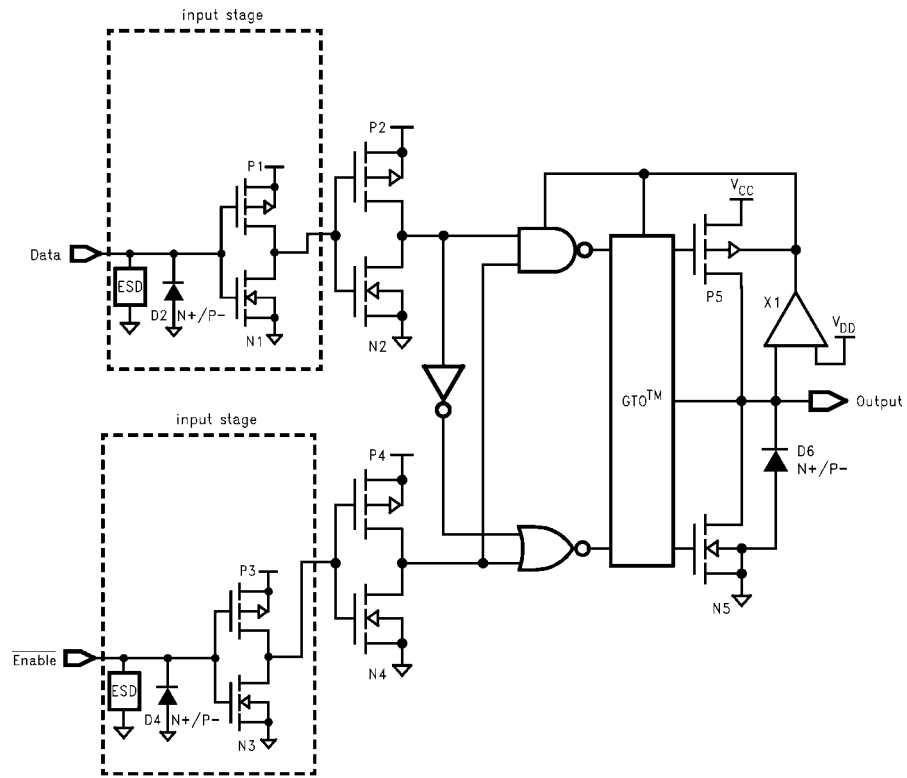

Physical Dimensions inches (millimeters) unless otherwise noted

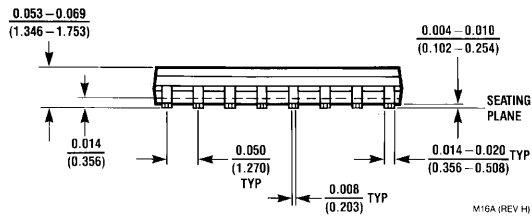
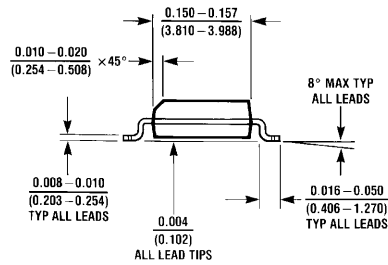
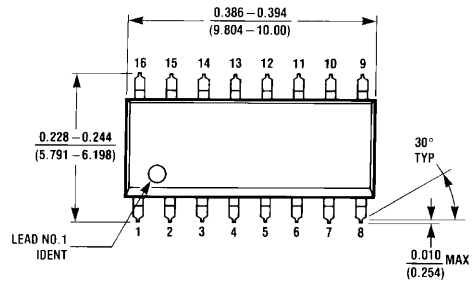

**16-Lead Small Outline Integrated Circuit (SOIC), JEDEC MS-012, 0.150" Narrow
Package Number M16A**

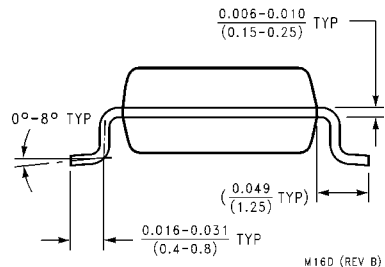
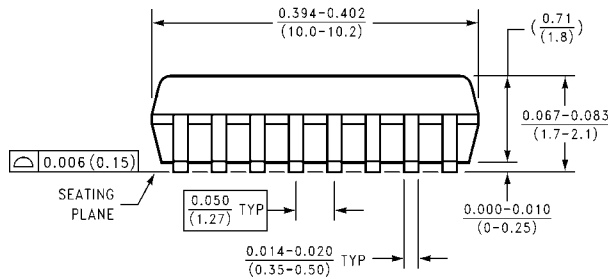
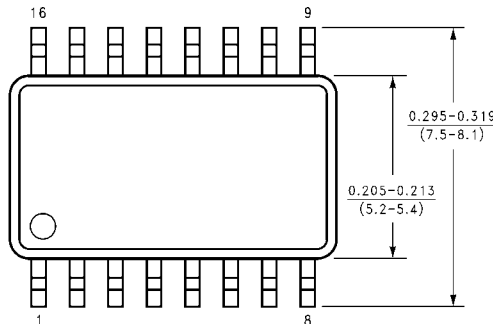

**16-Lead Small Outline Package (SOP), EIAJ TYPE II, 5.3mm Wide
Package Number M16D**

Physical Dimensions inches (millimeters) unless otherwise noted (Continued)

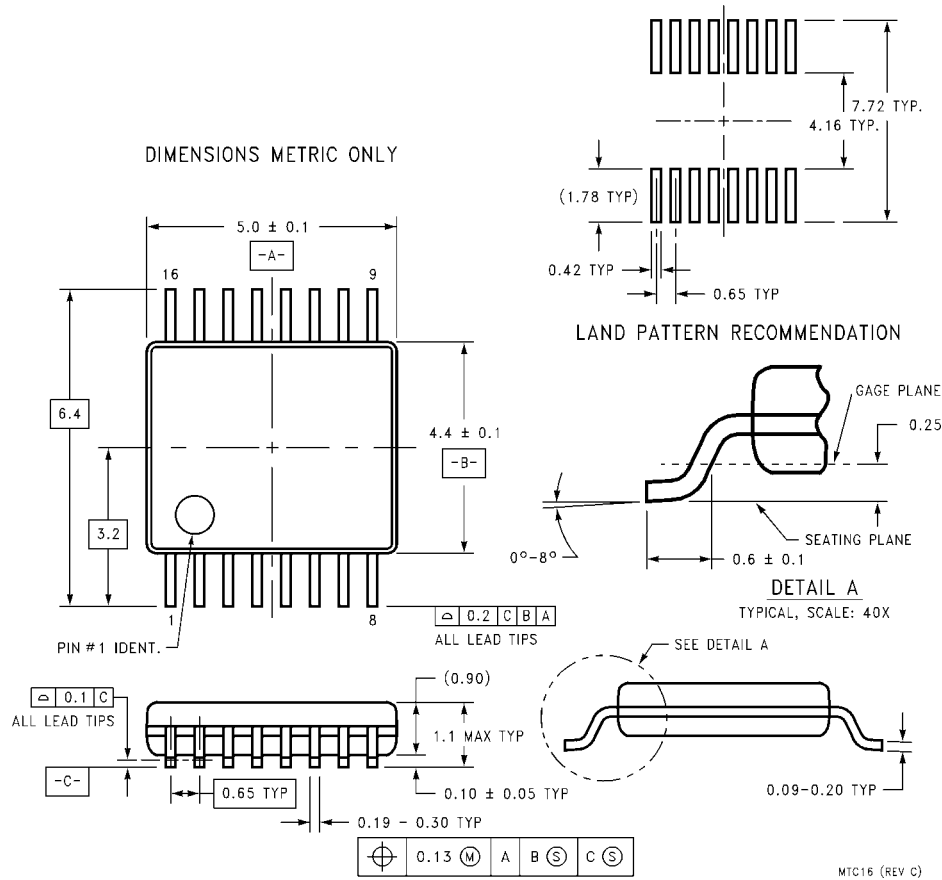

**16-Lead Thin Shrink Small Outline Package (TSSOP), JEDEC MO-153, 4.4mm Wide
Package Number MTC16**

LIFE SUPPORT POLICY

FAIRCHILD'S PRODUCTS ARE NOT AUTHORIZED FOR USE AS CRITICAL COMPONENTS IN LIFE SUPPORT DEVICES OR SYSTEMS WITHOUT THE EXPRESS WRITTEN APPROVAL OF THE PRESIDENT OF FAIRCHILD SEMICONDUCTOR CORPORATION. As used herein:

1. Life support devices or systems are devices or systems which, (a) are intended for surgical implant into the body, or (b) support or sustain life, and (c) whose failure to perform when properly used in accordance with instructions for use provided in the labeling, can be reasonably expected to result in a significant injury to the user.
2. A critical component in any component of a life support device or system whose failure to perform can be reasonably expected to cause the failure of the life support device or system, or to affect its safety or effectiveness.

www.fairchildsemi.com