

## 74LVQ174 Low Voltage Hex D-Type Flip-Flop with Master Reset

### General Description

The LVQ174 is a high-speed hex D-type flip-flop. The device is used primarily as a 6-bit edge-triggered storage register. The information on the D inputs is transferred to storage during the LOW-to-HIGH clock transition. The device has a Master Reset to simultaneously clear all flip-flops.

### Features

- Ideal for low power/low noise 3.3V applications
- Guaranteed simultaneous switching noise level and dynamic threshold performance
- Guaranteed pin-to-pin skew AC performance
- Guaranteed incident wave switching into 75Ω

### Ordering Code:

Order Number	Package Number	Package Description
74LVQ174SC	M16A	16-Lead (0.150" Wide) Small Outline Integrated Circuit, SOIC JEDEC
74LVQ174SJ	M16D	16-Lead Molded Small Outline Package, SOIC EIAJ

Devices also available in Tape and Reel. Specify by appending suffix letter "X" to the ordering code.

### Logic Symbols

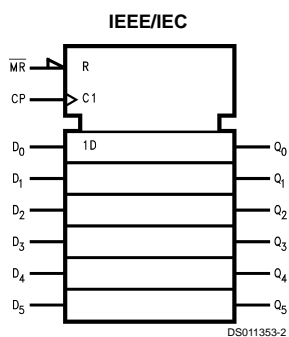
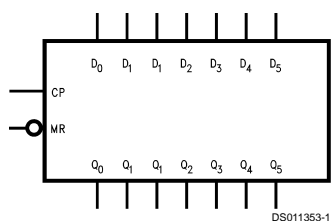

### Connection Diagram

Pin Assignment for SOIC JEDEC and EIAJ

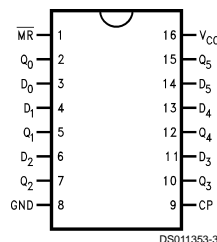

### Pin Descriptions

Pin Names	Description
D <sub>0</sub> -D <sub>5</sub>	Data Inputs
CP	Clock Pulse Input
$\overline{\text{MR}}$	Master Reset Input
Q <sub>0</sub> -Q <sub>5</sub>	Outputs

## Functional Description

The LVQ174 consists of six edge-triggered D flip-flops with individual D inputs and Q outputs. The Clock (CP) and Master Reset ( $\overline{MR}$ ) are common to all flip-flops. Each D input's state is transferred to the corresponding flip-flop's output following the LOW-to-HIGH Clock (CP) transition. A LOW input to the Master Reset ( $\overline{MR}$ ) will force all outputs LOW independent of Clock or Data inputs. The LVQ174 is useful for applications where the true output only is required and the Clock and Master Reset are common to all storage elements.

## Truth Table

Inputs			Output
$\overline{MR}$	CP	D	Q
L	X	X	L
H	↗	H	H
H	↗	L	L
H	L	X	Q

H = HIGH Voltage Level  
 L = LOW Voltage Level  
 X = Immaterial  
 ↗ = LOW-to-HIGH Transition

## Logic Diagram

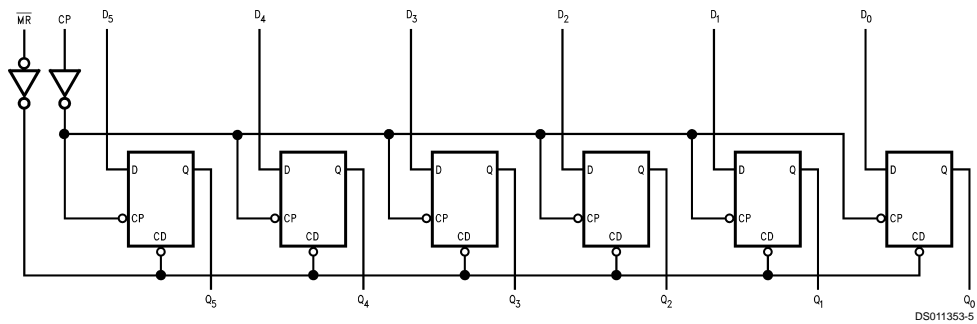

Please note that this diagram is provided only for the understanding of logic operations and should not be used to estimate propagation delays.

## Absolute Maximum Ratings (Note 1)

Supply Voltage ( $V_{CC}$ )	-0.5V to +7.0V
DC Input Diode Current ( $I_{IK}$ )	
$V_I = -0.5V$	-20 mA
$V_I = V_{CC} + 0.5V$	+20 mA
DC Input Voltage ( $V_I$ )	-0.5V to $V_{CC} + 0.5V$
DC Output Diode Current ( $I_{OK}$ )	
$V_O = -0.5V$	-20 mA
$V_O = V_{CC} + 0.5V$	+20 mA
DC Output Voltage ( $V_O$ )	-0.5V to $V_{CC} + 0.5V$
DC Output Source or Sink Current ( $I_O$ )	$\pm 50$ mA
DC $V_{CC}$ or Ground Current ( $I_{CC}$ or $I_{GND}$ )	$\pm 200$ mA
Storage Temperature ( $T_{STG}$ )	-65°C to +150°C
DC Latch-Up Source or Sink Current	$\pm 100$ mA

## Recommended Operating Conditions (Note 2)

Supply Voltage ( $V_{CC}$ )	2.0V to 3.6V
Input Voltage ( $V_I$ )	0V to $V_{CC}$
Output Voltage ( $V_O$ )	0V to $V_{CC}$
Operating Temperature ( $T_A$ )	-40°C to +85°C
Minimum Input Edge Rate ( $\Delta V/\Delta t$ )	
$V_{IN}$ from 0.8V to 2.0V	
$V_{CC}$ @ 3.0V	125 mV/ns

**Note 1:** The "Absolute Maximum Ratings" are those values beyond which the safety of the device cannot be guaranteed. The device should not be operated at these limits. The parametric values defined in the Electrical Characteristics tables are not guaranteed at the absolute maximum ratings. The "Recommended Operating Conditions" table will define the conditions for actual device operation.

**Note 2:** Unused inputs must be held HIGH or LOW. They may not float.

## DC Electrical Characteristics

Symbol	Parameter	$V_{CC}$ (V)	$T_A = +25^\circ C$		$T_A = -40^\circ C$ to $+85^\circ C$	Units	Conditions
			Typ	Guaranteed Limits			
$V_{IH}$	Minimum High Level Input Voltage	3.0	1.5	2.0	2.0	V	$V_{OUT} = 0.1V$ or $V_{CC} - 0.1V$
$V_{IL}$	Maximum Low Level Input Voltage	3.0	1.5	0.8	0.8	V	$V_{OUT} = 0.1V$ or $V_{CC} - 0.1V$
$V_{OH}$	Minimum High Level Output Voltage	3.0	2.99	2.9	2.9	V	$I_{OUT} = -50 \mu A$
		3.0		2.58	2.48	V	$V_{IN} = V_{IL}$ or $V_{IH}$ (Note 3) $I_{OH} = -12$ mA
$V_{OL}$	Maximum Low Level Output Voltage	3.0	0.002	0.1	0.1	V	$I_{OUT} = 50 \mu A$
		3.0		0.36	0.44	V	$V_{IN} = V_{IL}$ or $V_{IH}$ (Note 3) $I_{OL} = 12$ mA
$I_{IN}$	Maximum Input Leakage Current	3.6		$\pm 0.1$	$\pm 1.0$	$\mu A$	$V_I = V_{CC}, GND$
$I_{OLD}$	Minimum Dynamic (Note 4)	3.6			36	mA	$V_{OLD} = 0.8V$ Max (Note 5)
$I_{OHD}$	Output Current	3.6			-25	mA	$V_{OHD} = 2.0V$ Min (Note 5)
$I_{CC}$	Maximum Quiescent Supply Current	3.6		4.0	40.0	$\mu A$	$V_{IN} = V_{CC}$ or GND
$V_{OLP}$	Quiet Output Maximum Dynamic $V_{OL}$	3.3	0.7	0.8		V	(Notes 6, 7)
$V_{OLV}$	Quiet Output Minimum Dynamic $V_{OL}$	3.3	-0.6	-0.8		V	(Notes 6, 7)
$V_{IHD}$	Maximum High Level Dynamic Input Voltage	3.3	1.8	2.0		V	(Notes 6, 8)
$V_{ILD}$	Maximum Low Level Dynamic Input Voltage	3.3	1.6	0.8		V	(Notes 6, 8)

**Note 3:** All outputs loaded; thresholds on input associated with output under test.

**Note 4:** Maximum test duration 2.0 ms, one output loaded at a time.

**Note 5:** Incident wave switching on transmission lines with impedances as low as 75 $\Omega$  for commercial temperature range is guaranteed.

**Note 6:** Worst case package.

**Note 7:** Max number of outputs defined as (n). Data inputs are driven 0V to 3.3V; one output at GND.

**Note 8:** Max number of Data Inputs (n) switching. (n - 1) inputs switching 0V to 3.3V. Input-under-test switching: 3.3V to threshold ( $V_{ILD}$ ), 0V to threshold ( $V_{IHD}$ ), f = 1 MHz.

## AC Electrical Characteristics

Symbol	Parameter	V <sub>CC</sub> (V)	T <sub>A</sub> = +25°C C <sub>L</sub> = 50 pF			T <sub>A</sub> = -40°C to +85°C C <sub>L</sub> = 50 pF		Units
			Min	Typ	Max	Min	Max	
f <sub>max</sub>	Maximum Clock Frequency	2.7 3.3 ±0.3	60 90	90 100		50 70		MHz
t <sub>PLH</sub>	Propagation Delay CP to Q <sub>n</sub>	2.7 3.3 ±0.3	2.0 2.0	10.8 9.0	16.2 11.5	1.5 1.5	18.0 12.5	ns
t <sub>PHL</sub>	Propagation Delay CP to Q <sub>n</sub>	2.7 3.3 ±0.3	2.0 2.0	10.2 8.5	15.5 11.0	1.5 1.5	17.0 12.0	ns
t <sub>PHL</sub>	Propagation Delay $\overline{MR}$ to Q <sub>n</sub>	2.7 3.3 ±0.3	2.5 2.5	10.8 9.0	16.2 11.5	2.0 2.0	18.0 12.5	ns
t <sub>OSHL</sub>	Output to	2.7		1.0	1.5		1.5	ns
t <sub>OSLH</sub>	Output Skew (Note 9)	3.3 ±0.3		1.0	1.5		1.5	ns

**Note 9:** Skew is defined as the absolute value of the difference between the actual propagation delay for any two separate outputs of the same device. The specification applies to any outputs switching in the same direction, either HIGH to LOW (t<sub>OSHL</sub>) or LOW to HIGH (t<sub>OSLH</sub>). Parameter guaranteed by design.

## AC Operating Requirements

Symbol	Parameter	V <sub>CC</sub> (V)	T <sub>A</sub> = +25°C C <sub>L</sub> = 50 pF		T <sub>A</sub> = -40°C to +85°C C <sub>L</sub> = 50 pF	Units
			Typ	Guaranteed Minimum		
t <sub>s</sub>	Setup Time, HIGH or LOW D <sub>n</sub> to CP	2.7 3.3 ±0.3	3.0 2.5	8.0 6.5	10.0 7.0	ns
t <sub>H</sub>	Hold Time, HIGH or LOW D <sub>n</sub> to CP	2.7 3.3 ±0.3	1.2 1.0	4.0 3.0	4.5 3.0	ns
t <sub>w</sub>	$\overline{MR}$ Pulse Width, LOW	2.7 3.3 ±0.3	1.2 1.0	7.0 5.5	10.0 7.0	ns
t <sub>w</sub>	CP Pulse Width	2.7 3.3 ±0.3	1.2 1.0	7.0 5.5	10.0 7.0	ns
t <sub>rec</sub>	Recovery Time $\overline{MR}$ to CP	2.7 3.3 ±0.3	0 0	3.5 2.5	3.5 2.5	ns

## Capacitance

Symbol	Parameter	Typ	Units	Conditions
C <sub>IN</sub>	Input Capacitance	4.5	pF	V <sub>CC</sub> = Open
C <sub>PD</sub> (Note 10)	Power Dissipation Capacitance	23	pF	V <sub>CC</sub> = 3.3V

**Note 10:** C<sub>PD</sub> is measured at 10 MHz.

**Physical Dimensions** inches (millimeters) unless otherwise noted

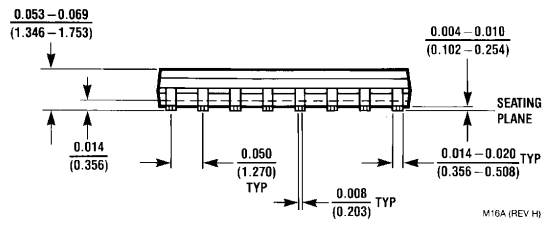
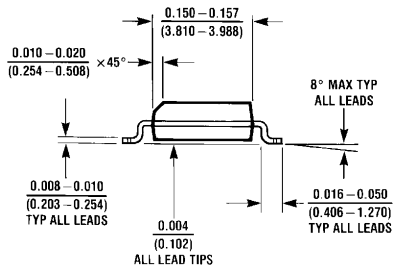
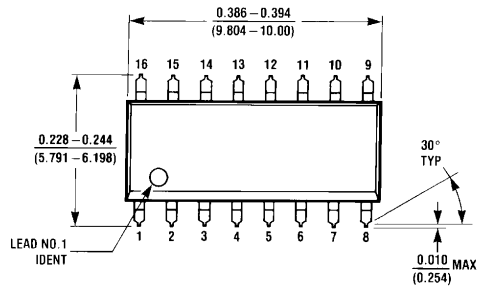

M16A (REV H)

**16-Lead (0.150" Wide) Small Outline Integrated Circuit, SOIC JEDEC  
Package Number M16A**

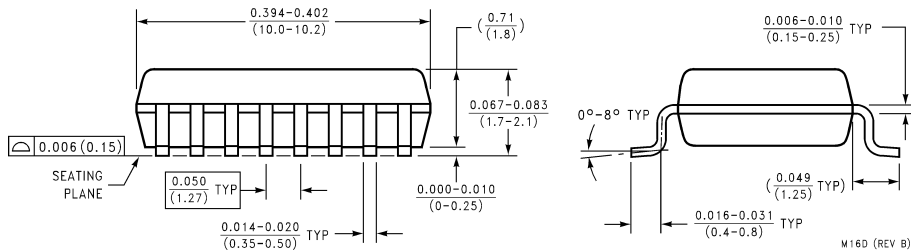
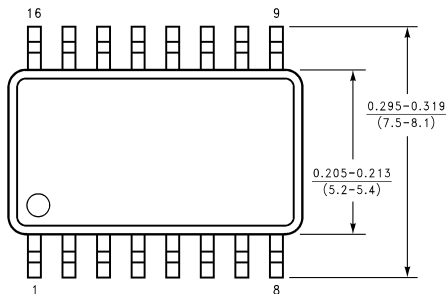

M16D (REV B)

**16-Lead Molded Small Outline Package, SOIC EIAJ  
Package Number M16D**

**LIFE SUPPORT POLICY**

FAIRCHILD'S PRODUCTS ARE NOT AUTHORIZED FOR USE AS CRITICAL COMPONENTS IN LIFE SUPPORT DEVICES OR SYSTEMS WITHOUT THE EXPRESS WRITTEN APPROVAL OF THE PRESIDENT OF FAIRCHILD SEMICONDUCTOR CORPORATION. As used herein:

1. Life support devices or systems are devices or systems which, (a) are intended for surgical implant into the body, or (b) support or sustain life, and (c) whose failure to perform when properly used in accordance with instructions for use provided in the labeling, can be reasonably expected to result in a significant injury to the user.
2. A critical component in any component of a life support device or system whose failure to perform can be reasonably expected to cause the failure of the life support device or system, or to affect its safety or effectiveness.

**Fairchild Semiconductor Corporation Americas**  
Customer Response Center  
Tel: 1-888-522-5372  
Fax: 972-910-8036

**Fairchild Semiconductor Europe**  
Fax: +49 (0) 1 80-530 85 86  
Email: europe.support@nsc.com  
Deutsch Tel: +49 (0) 8 141-35-0  
English Tel: +44 (0) 1 793-85-68-56  
Italy Tel: +39 (0) 2 57 5631

**Fairchild Semiconductor Hong Kong Ltd.**  
8/F Room 808 Empire Centre  
68 Mody Road, Tsimshatsui East  
Kowloon, Hong Kong  
Tel: 852-2722-8338  
Fax: 852-2722-8383

**Fairchild Semiconductor Japan Ltd.**  
4F, Natsume Bldg,  
2-18-6 Yushima, Bunkyo-ku,  
Tokyo 113-0034, Japan  
Tel: 81-3-3818-8840  
Fax: 81-3-3818-8450

[www.fairchildsemi.com](http://www.fairchildsemi.com)