

74LVX138 Low Voltage 1-of-8 Decoder/Demultiplexer

General Description

The LVX138 is a high-speed 1-of-8 decoder/demultiplexer. This device is ideally suited for high-speed bipolar memory chip select address decoding. The multiple input enables allow parallel expansion to a 1-of-24 decoder using just three LVX138 devices or a 1-of-32 decoder using four LVX138 devices and one inverter.

Features

- Input voltage level translation from 5V to 3V
- Ideal for low power/low noise 3.3V applications
- Guaranteed simultaneous switching noise level and dynamic threshold performance

Ordering Code:

| Order Number | Package Number | Package Description |
|--------------|----------------|--|
| 74LVX138M | M16A | 16-Lead Small Outline Integrated Circuit (SOIC), JEDEC MS-012, 0.150" Narrow |
| 74LVX138SJ | M16D | 16-Lead Small Outline Package (SOP), EIAJ TYPE II, 5.3mm Wide |
| 74LVX138MTC | MTC16 | 16-Lead Thin Shrink Small Outline Package (TSSOP), JEDEC MO-153, 4.4mm Wide |

Devices also available in Tape and Reel. Specify by appending suffix letter "X" to the ordering code.

Logic Symbols

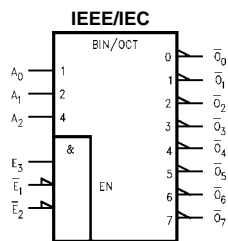
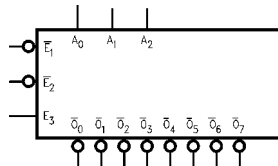

Connection Diagram

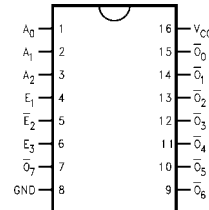

Pin Descriptions

| Pin Names | Description |
|--------------------------------|----------------|
| A ₀ -A ₂ | Address Inputs |
| \bar{E}_1 - \bar{E}_2 | Enable Inputs |
| E ₃ | Enable Input |
| \bar{O}_0 - \bar{O}_7 | Outputs |

Functional Description

The LVX138 high-speed 1-of-8 decoder/demultiplexer accepts three binary weighted inputs (A_0, A_1, A_2) and, when enabled, provides eight mutually exclusive active-LOW outputs ($\bar{O}_0-\bar{O}_7$). The LVX138 features three Enable inputs, two active-LOW (\bar{E}_1, \bar{E}_2) and one active-HIGH (E_3).

All outputs will be HIGH unless \bar{E}_1 and \bar{E}_2 are LOW and E_3 is HIGH.

The LVX138 can be used as an 8-output demultiplexer by using one of the active LOW Enable inputs as the data input and the other Enable inputs as strobes. The Enable inputs which are not used must be permanently tied to their appropriate active-HIGH or active-LOW state.

Truth Table

| Inputs | | | | | | Outputs | | | | | | | |
|-------------|-------------|-------|-------|-------|-------|-------------|-------------|-------------|-------------|-------------|-------------|-------------|-------------|
| \bar{E}_1 | \bar{E}_2 | E_3 | A_0 | A_1 | A_2 | \bar{O}_0 | \bar{O}_1 | \bar{O}_2 | \bar{O}_3 | \bar{O}_4 | \bar{O}_5 | \bar{O}_6 | \bar{O}_7 |
| H | X | X | X | X | X | H | H | H | H | H | H | H | H |
| X | H | X | X | X | X | H | H | H | H | H | H | H | H |
| X | X | L | X | X | X | H | H | H | H | H | H | H | H |
| L | L | H | L | L | L | L | H | H | H | H | H | H | H |
| L | L | H | H | L | L | H | L | H | H | H | H | H | H |
| L | L | H | L | H | L | H | H | L | H | H | H | H | H |
| L | L | H | H | H | L | H | H | H | L | H | H | H | H |
| L | L | H | L | L | H | H | H | H | H | L | H | H | H |
| L | L | H | H | L | H | H | H | H | H | H | L | H | H |
| L | L | H | L | H | H | H | H | H | H | H | H | L | H |
| L | L | H | H | H | H | H | H | H | H | H | H | H | L |

H = HIGH Voltage Level
 L = LOW Voltage Level
 X = Immaterial

Logic Diagram

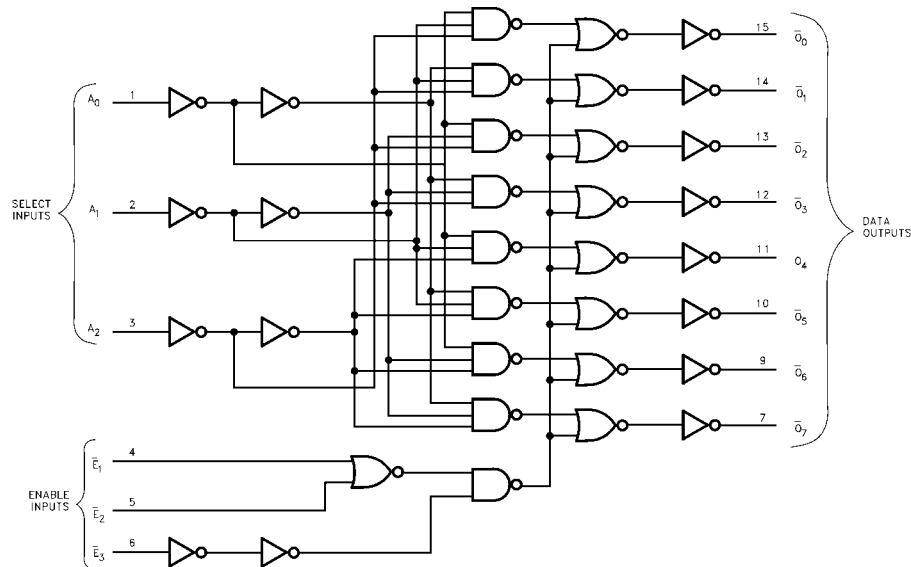

Please note that this diagram is provided only for the understanding of logic operations and should not be used to estimate propagation delays.

Absolute Maximum Ratings (Note 1)

| | |
|---|--------------------------|
| Supply Voltage (V_{CC}) | -0.5V to +7.0V |
| DC Input Diode Current (I_{IK}) | -20 mA |
| $V_I = -0.5V$ | -20 mA |
| DC Input Voltage (V_I) | -0.5V to 7V |
| DC Output Diode Current (I_{OK}) | -20 mA |
| $V_O = -0.5V$ | -20 mA |
| $V_O = V_{CC} + 0.5V$ | +20 mA |
| DC Output Voltage (V_O) | -0.5V to $V_{CC} + 0.5V$ |
| DC Output Source or Sink Current (I_O) | ± 25 mA |
| DC V_{CC} or Ground Current (I_{CC} or I_{GND}) | ± 75 mA |
| Storage Temperature (T_{STG}) | -65°C to +150°C |
| Power Dissipation | 180 mW |

Recommended Operating Conditions (Note 2)

| | |
|--|--------------------|
| Supply Voltage (V_{CC}) | 2.0V to 3.6V |
| Input Voltage (V_I) | 0V to 5.5V |
| Output Voltage (V_O) | 0V to V_{CC} |
| Operating Temperature (T_A) | -40°C to +85°C |
| Input Rise and Fall Time ($\Delta t/\Delta V$) | 0 ns/V to 100 ns/V |

Note 1: The "Absolute Maximum Ratings" are those values beyond which the safety of the device cannot be guaranteed. The device should not be operated at these limits. The parametric values defined in the Electrical Characteristics tables are not guaranteed at the absolute maximum ratings. The "Recommended Operating Conditions" table will define the conditions for actual device operation.

Note 2: Unused inputs must be held HIGH or LOW. They may not float.

DC Electrical Characteristics

| Symbol | Parameter | V_{CC} | $T_A = +25^\circ\text{C}$ | | | $T_A = -40^\circ\text{C to } +85^\circ\text{C}$ | | Units | Conditions |
|----------|------------------------------|----------|---------------------------|-----|-----------|---|-----------|---------------|--|
| | | | Min | Typ | Max | Min | Max | | |
| V_{IH} | HIGH Level Input Voltage | 2.0 | 1.5 | | | 1.5 | | V | |
| | | 3.0 | 2.0 | | | 2.0 | | | |
| | | 3.6 | 2.4 | | | 2.4 | | | |
| V_{IL} | LOW Level Input Voltage | 2.0 | | | 0.5 | | 0.5 | V | |
| | | 3.0 | | | 0.8 | | 0.8 | | |
| | | 3.6 | | | 0.8 | | 0.8 | | |
| V_{OH} | HIGH Level Output Voltage | 2.0 | 1.9 | 2.0 | | 1.9 | | V | $V_{IN} = V_{IL}$ or V_{IH} $I_{OH} = -50 \mu\text{A}$ $I_{OH} = -50 \mu\text{A}$ $I_{OH} = -4 \text{mA}$ |
| | | 3.0 | 2.9 | 3.0 | | 2.9 | | | |
| | | 3.0 | 2.58 | | | 2.48 | | | |
| V_{OL} | LOW Level Output Voltage | 2.0 | | 0.0 | 0.1 | | 0.1 | V | $V_{IN} = V_{IL}$ or V_{IH} $I_{OL} = 50 \mu\text{A}$ $I_{OL} = 50 \mu\text{A}$ $I_{OL} = 4 \text{mA}$ |
| | | 3.0 | | 0.0 | 0.1 | | 0.1 | | |
| | | 3.0 | | | 0.36 | | 0.44 | | |
| I_{IN} | Input Leakage Current | 3.6 | | | ± 0.1 | | ± 1.0 | μA | $V_{IN} = 5.5V$ or GND |
| I_{CC} | Quiescent Supply Current | 3.6 | | | 4.0 | | 40.0 | μA | $V_{IN} = V_{CC}$ or GND |

Noise Characteristics (Note 3)

| Symbol | Parameter | V_{CC} (V) | $T_A = 25^\circ\text{C}$ | | Units | C_L (pF) |
|-----------|--|-----------------|--------------------------|-------|-------|------------|
| | | | Typ | Limit | | |
| V_{OLP} | Quiet Output Maximum Dynamic V_{OL} | 3.3 | 0.3 | 0.5 | V | 50 |
| V_{OLV} | Quiet Output Minimum Dynamic V_{OL} | 3.3 | -0.3 | -0.5 | V | 50 |
| V_{IHD} | Minimum HIGH Level Dynamic Input Voltage | 3.3 | | 2.0 | V | 50 |
| V_{ILD} | Maximum LOW Level Dynamic Input Voltage | 3.3 | | 0.8 | V | 50 |

Note 3: Input $t_r = t_f = 3$ ns

AC Electrical Characteristics

| Symbol | Parameter | V _{CC} (V) | T _A = +25°C | | | T _A = -40°C to +85°C | | Units | CL (pF) |
|-------------------|--|------------------------|------------------------|------|------|---------------------------------|------|-------|---------|
| | | | Min | Typ | Max | Min | Max | | |
| t _{PLH} | Propagation Delay Time | 2.7 | | 7.1 | 13.8 | 1.0 | 16.5 | ns | 15 |
| t _{PHL} | A _n to \overline{O}_n | 3.3 ± 0.3 | | 9.6 | 17.3 | 1.0 | 20.0 | | 50 |
| | | | | 5.5 | 8.8 | 1.0 | 10.5 | | 15 |
| | | | | 8.0 | 12.3 | 1.0 | 14.0 | | 50 |
| t _{PLH} | Propagation Delay Time | 2.7 | | 8.8 | 16.0 | 1.0 | 18.5 | ns | 15 |
| t _{PHL} | \overline{E}_1 or \overline{E}_2 to \overline{O}_n | 3.3 ± 0.3 | | 11.3 | 19.5 | 1.0 | 22.0 | | 50 |
| | | | | 6.9 | 10.4 | 1.0 | 11.5 | | 15 |
| | | | | 9.4 | 13.9 | 1.0 | 15.0 | | 50 |
| t _{PLH} | Propagation Delay Time | 2.7 | | 8.7 | 16.3 | 1.0 | 19.5 | ns | 15 |
| t _{PHL} | E ₃ to \overline{O}_n | 3.3 ± 0.3 | | 11.2 | 19.8 | 1.0 | 23.0 | | 50 |
| | | | | 6.8 | 10.6 | 1.0 | 12.5 | | 15 |
| | | | | 9.3 | 14.1 | 1.0 | 16.0 | | 50 |
| t _{OSHL} | Output to Output Skew (Note 4) | 2.7 | | | 1.5 | | 1.5 | ns | 50 |
| t _{OSLH} | | 3.3 | | | 1.5 | | 1.5 | | |

Note 4: Parameter guaranteed by design. $t_{OSLH} = |t_{PLHm} - t_{PLHn}|$, $t_{OSHL} = |t_{PHLm} - t_{PHLn}|$

Capacitance

| Symbol | Parameter | T _A = +25°C | | | T _A = -40°C to +85°C | | Units |
|-----------------|--|------------------------|-----|-----|---------------------------------|-----|-------|
| | | Min | Typ | Max | Min | Max | |
| C _{IN} | Input Capacitance | | 4 | 10 | | 10 | pF |
| C _{PD} | Power Dissipation Capacitance (Note 5) | | 34 | | | | pF |

Note 5: C_{PD} is defined as the value of the internal equivalent capacitance which is calculated from the operating current consumption without load.

Average operating current can be obtained by the equation: $C_{PD} \times V_{CC} \times I_{IN} + I_{CC}$

Physical Dimensions inches (millimeters) unless otherwise noted

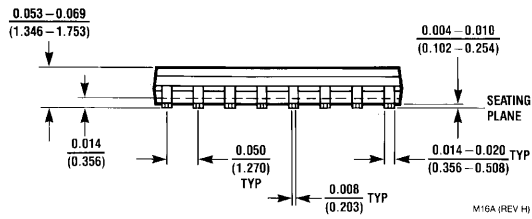
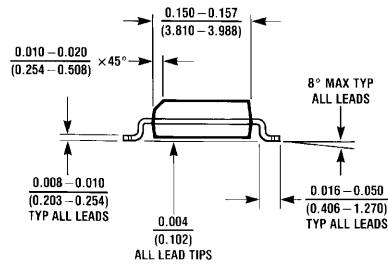
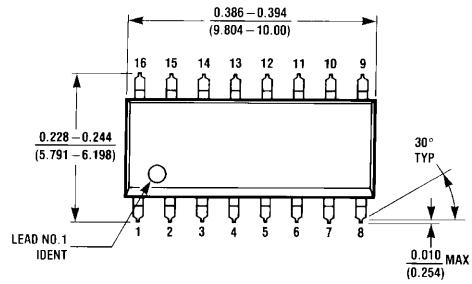

**16-Lead Small Outline Integrated Circuit (SOIC), JEDEC MS-012, 0.150" Narrow
Package Number M16A**

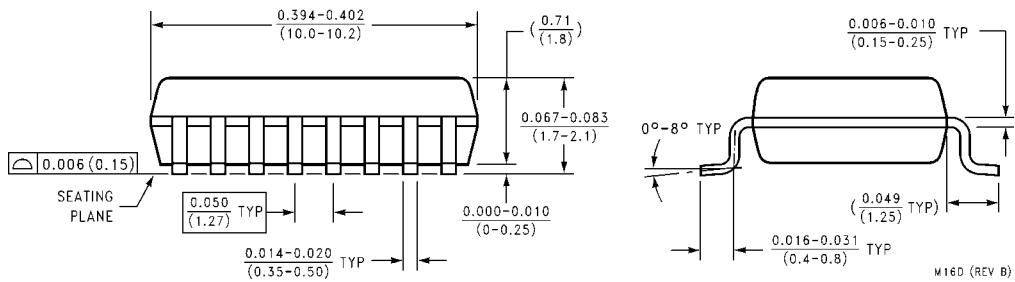
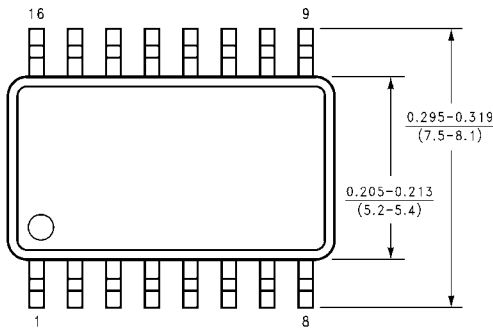

**16-Lead Small Outline Package (SOP) EIAJ TYPE II, 5.3mm Wide
Package Number M16D**

Physical Dimensions inches (millimeters) unless otherwise noted (Continued)

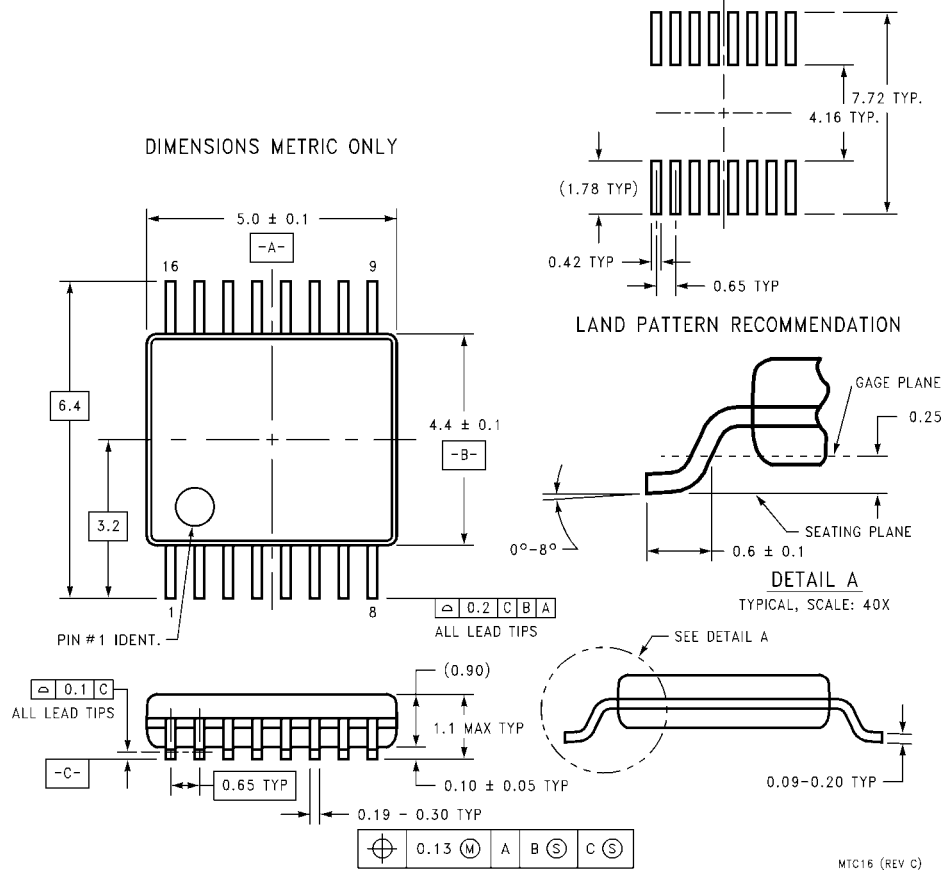

**16-Lead Thin Shrink Small Outline Package (TSSOP), JEDEC MO-153, 4.4mm Wide
Package Number MTC16**

LIFE SUPPORT POLICY

FAIRCHILD'S PRODUCTS ARE NOT AUTHORIZED FOR USE AS CRITICAL COMPONENTS IN LIFE SUPPORT DEVICES OR SYSTEMS WITHOUT THE EXPRESS WRITTEN APPROVAL OF THE PRESIDENT OF FAIRCHILD SEMICONDUCTOR CORPORATION. As used herein:

1. Life support devices or systems are devices or systems which, (a) are intended for surgical implant into the body, or (b) support or sustain life, and (c) whose failure to perform when properly used in accordance with instructions for use provided in the labeling, can be reasonably expected to result in a significant injury to the user.
2. A critical component in any component of a life support device or system whose failure to perform can be reasonably expected to cause the failure of the life support device or system, or to affect its safety or effectiveness.

www.fairchildsemi.com