

74LVXC3245

8-Bit Dual Supply Configurable Voltage Interface Transceiver with 3-STATE Outputs

General Description

The LVXC3245 is a 24-pin dual-supply, 8-bit configurable voltage interface transceiver suited for PCMCIA and other real time configurable I/O applications. The V_{CCA} pin accepts a 3V supply level. The A Port is a dedicated 3V port. The V_{CCB} pin accepts a 3V-to-5V supply level. The B Port is configured to track the V_{CCB} supply level respectively. A 5V level on the V_{CC} pin will configure the I/O pins at a 5V level and a 3V V_{CC} will configure the I/O pins at a 3V level. The A Port should interface with a 3V host system and the B Port to the card slots. This device will allow the V_{CCB} voltage source pin and I/O pins on the B Port to float when \overline{OE} is HIGH. This feature is necessary to buffer data to and from a PCMCIA socket that permits PCMCIA cards to be inserted and removed during normal operation.

Features

- Bidirectional interface between 3V and 3V-to-5V buses
- Control inputs compatible with TTL level
- Outputs source/sink up to 24 mA
- Guaranteed simultaneous switching noise level and dynamic threshold performance
- Implements patented EMI reduction circuitry
- Flexible V_{CCB} operating range
- Allows B Port and V_{CCB} to float simultaneously when \overline{OE} is HIGH
- Functionally compatible with the 74 series 245

Ordering Code:

Order Number	Package Number	Package Description
74LVXC3245WM	M24B	24-Lead Small Outline Integrated Circuit (SOIC), JEDEC MS-013, 0.300" Wide
74LVXC3245QSC	MQA24	24-Lead Quarter Size Outline Package (QSOP), JEDEC MO-137, 0.150" Wide
74LVXC3245MTC	MTC24	24-Lead Thin Shrink Small Outline Package (TSSOP), JEDEC MO-153, 4.4mm Wide

Devices also available in Tape and Reel. Specify by appending suffix letter "X" to the ordering code.

Logic Symbol

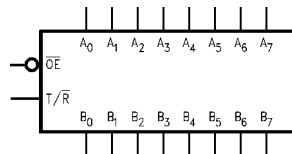

Connection Diagram

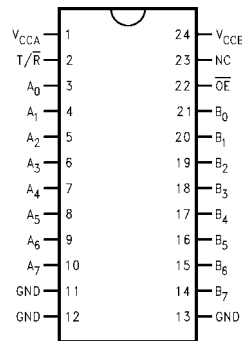

Pin Descriptions

Pin Names	Description
\overline{OE}	Output Enable Input
T/\overline{R}	Transmit/Receive Input
A_0 - A_7	Side A Inputs or 3-STATE Outputs
B_0 - B_7	Side B Inputs or 3-STATE Outputs

Truth Table

Inputs		Outputs
\overline{OE}	$\overline{T/R}$	
L	L	Bus B Data to Bus A
L	H	Bus A Data to Bus B
H	X	HIGH-Z State

H = HIGH Voltage Level
 L = LOW Voltage Level
 X = Immaterial

Logic Diagram

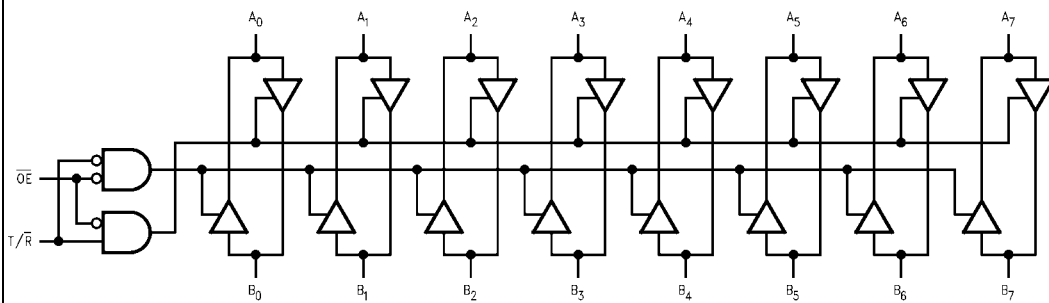

Absolute Maximum Ratings (Note 1)			Recommended Operating Conditions (Note 2)				
Supply Voltage (V_{CCA}, V_{CCB})	-0.5V to +7.0V		Supply Voltage	2.7V to 3.6V			
DC Input Voltage (V_I) @ $\overline{OE}, T/\overline{R}$	-0.5V to $V_{CCA} + 0.5V$		V_{CCA}	3.0V to 5.5V			
DC Input/Output Voltage ($V_{I/O}$)	-0.5V to $V_{CCA} + 0.5V$		V_{CCB}	0V to V_{CCA}			
@ A_n	-0.5V to $V_{CCA} + 0.5V$		Input Voltage (V_I) @ $\overline{OE}, T/\overline{R}$	0V to V_{CCA}			
@ B_n	-0.5V to $V_{CCB} + 0.5V$		Input Output Voltage ($V_{I/O}$)	0V to V_{CCA}			
DC Input Diode Current (I_{IK})	±20 mA		@ A_n	0V to V_{CCB}			
@ $\overline{OE}, T/\overline{R}$	±50 mA		@ B_n	-40°C to +85°C			
DC Output Diode (I_{OK}) Current	±50 mA		Free Air Operating Temperature (T_A)	8 ns/V			
DC Output Source or Sink Current (I_O)	±50 mA		Minimum Input Edge Rate ($\Delta V/\Delta t$)	V_{IN} from 30% to 70% of V_{CC}			
DC V_{CC} or Ground Current	±50 mA		V_{CC} @ 3.0V, 4.5V, 5.5V				
per Output Pin (I_{CC} or I_{GND})	±200 mA						
and Max Current	±200 mA						
Storage Temperature Range (T_{STG})	-65°C to +150°C						
DC Latch-Up Source or Sink Current	±300 mA						

Note 1: The "Absolute Maximum Ratings" are those values beyond which the safety of the device cannot be guaranteed. The device should not be operated at these limits. The parametric values defined in the Electrical Characteristics tables are not guaranteed at the absolute maximum ratings. The "Recommended Operating Conditions" table will define the conditions for actual device operation.

Note 2: The A Port unused pins (inputs or I/Os) must be held HIGH or LOW. They may not float.

DC Electrical Characteristics

Symbol	Parameter	V_{CCA} (V)	V_{CCB} (V)	$T_A = 25^\circ\text{C}$		$T_A = -40^\circ\text{C to } +85^\circ\text{C}$		Units	Conditions
				Typ	Guaranteed Limits	Typ	Guaranteed Limits		
V_{IHA}	Minimum HIGH Level Input Voltage	A_n	2.7	3.0		2.0	2.0	V	$V_{OUT} \leq 0.1V$ or $\geq V_{CC} - 0.1V$
		\overline{OE}	3.0	3.6		2.0	2.0		
		T/\overline{R}	3.6	5.5		2.0	2.0		
V_{IHB}		B_n	2.7	3.0		2.0	2.0	V	
			3.0	3.6		2.0	2.0		
			3.6	5.5		3.85	3.85		
V_{ILA}	Maximum LOW Level Input Voltage	A_n	2.7	3.0		0.8	0.8	V	$V_{OUT} \leq 0.1V$ or $\geq V_{CC} - 0.1V$
		\overline{OE}	3.0	3.6		0.8	0.8		
		T/\overline{R}	3.6	5.5		0.8	0.8		
V_{ILB}		B_n	2.7	3.0		0.8	0.8	V	
			3.0	3.6		0.8	0.8		
			3.6	5.5		1.65	1.65		
V_{OHA}	Minimum HIGH Level Output Voltage		3.0	3.0	2.99	2.9	2.9	V	$I_{OUT} = -100 \mu\text{A}$ $I_{OH} = -12 \text{ mA}$ $I_{OH} = -24 \text{ mA}$ $I_{OH} = -12 \text{ mA}$ $I_{OH} = -24 \text{ mA}$
			3.0	3.0	2.85	2.56	2.46		
			3.0	3.0	2.65	2.35	2.25		
			2.7	3.0	2.5	2.3	2.2		
			2.7	4.5	2.3	2.1	2.0		
V_{OHB}			3.0	3.0	2.99	2.9	2.9	V	$I_{OUT} = -100 \mu\text{A}$ $I_{OH} = -12 \text{ mA}$ $I_{OH} = -24 \text{ mA}$ $I_{OH} = -24 \text{ mA}$
			3.0	3.0	2.85	2.56	2.46		
			3.0	3.0	2.65	2.35	2.25		
			3.0	4.5	4.25	3.86	3.76		
			3.0	3.0	0.002	0.1	0.1		
V_{OLA}	Maximum LOW Level Output Voltage		3.0	3.0	0.002	0.1	0.1	V	$I_{OUT} = 100 \mu\text{A}$ $I_{OL} = 24 \text{ mA}$ $I_{OL} = 12 \text{ mA}$ $I_{OL} = 24 \text{ mA}$
			3.0	3.0	0.21	0.36	0.44		
			2.7	3.0	0.11	0.36	0.44		
			2.7	4.5	0.22	0.42	0.5		
V_{OLB}			3.0	3.0	0.002	0.1	0.1	V	$I_{OUT} = 100 \mu\text{A}$ $I_{OL} = 24 \text{ mA}$ $I_{OL} = 24 \text{ mA}$
			3.0	3.0	0.21	0.36	0.44		
			3.0	4.5	0.18	0.36	0.44		
I_{IN}	Maximum Input Leakage Current @ $\overline{OE}, T/\overline{R}$		3.6	3.6		±0.1	±1.0	μA	$V_I = V_{CCA}, \text{GND}$
			3.6	5.5		±0.1	±1.0		

DC Electrical Characteristics (Continued)

Symbol	Parameter	V _{CCA} (V)	V _{CCB} (V)	T _A = 25°C		T _A = -40°C to +85°C		Units	Conditions
				Typ	Guaranteed Limits				
I _{OZA}	Maximum 3-STATE Output Leakage @ A _n	3.6	3.6		±0.5	±5.0	μA	V _I = V _{IL} , V _{IH} , OE = V _{CCA} , V _O = V _{CCA} , GND	
		3.6	5.5		±0.5	±5.0			
I _{OZB}	Maximum 3-STATE Output Leakage @ B _n	3.6	3.6		±0.5	±5.0	μA	V _I = V _{IL} , V _{IH} , OE = V _{CCA} , V _O = V _{CCB} , GND	
		3.6	5.5		±0.5	±5.0			
ΔI _{CC}	Maximum I _{CC} /Input	B _n	3.6	5.5	1.0	1.35	mA	V _I = V _{CCB} -2.1V V _I = V _{CC} -0.6V	
		All Inputs	3.6	3.6		0.35			0.5
I _{CCA1}	Quiescent V _{CCA} Supply Current as B Port Floats	3.6	Open		5	50	μA	A _n = V _{CCA} or GND B _n = Open, OE = V _{CCA} , T/R = V _{CCA} , V _{CCB} = Open	
I _{CCA2}	Quiescent V _{CCA} Supply Current	3.6	3.6		5	50	μA	A _n = V _{CCA} or GND, B _n = V _{CCB} or GND, OE = GND, T/R = GND	
		3.6	5.5		5	50			
I _{CCB}	Quiescent V _{CCB} Supply Current	3.6	3.6		5	50	μA	A _n = V _{CCA} or GND, B _n = V _{CCB} or GND, OE = GND, T/R = V _{CCA}	
		3.6	5.5		8	80			
V _{OLPA}	Quiet Output Maximum Dynamic	3.3	3.3		0.8		V	(Note 3)(Note 4)	
		3.3	5.0		0.8				
V _{OLPB}	V _{OL}	3.3	3.3		0.8		V	(Note 3)(Note 4)	
		3.3	5.0		1.5				
V _{OLVA}	Quiet Output Minimum Dynamic	3.3	3.3		-0.8		V	(Note 3)(Note 4)	
		3.3	5.0		-0.8				
V _{OLVB}	V _{OL}	3.3	3.3		-0.8		V	(Note 3)(Note 4)	
		3.3	5.0		-1.2				
V _{IHDA}	Minimum HIGH Level Dynamic	3.3	3.3		2.0		V	(Note 3)(Note 5)	
		3.3	5.0		2.0				
V _{IHDB}	Input Voltage	3.3	3.3		2.0		V	(Note 3)(Note 5)	
		3.3	5.0		3.5				
V _{ILDA}	Maximum LOW Level Dynamic	3.3	3.3		0.8		V	(Note 3)(Note 5)	
		3.3	5.0		0.8				
V _{ILDB}	Input Voltage	3.3	3.3		0.8		V	(Note 3)(Note 5)	
		3.3	5.0		1.5				

Note 3: Worst case package.

Note 4: Max number of outputs defined as (n). Data inputs are driven 0V to V_{CC} level; one output at GND.

Note 5: Max number of Data Inputs (n) switching. (n-1) inputs switching 0V to V_{CC} level. Input-under-test switching: V_{CC} level to threshold (V_{IHD}), 0V to threshold (V_{ILD}), f = 1 MHz.

AC Electrical Characteristics												
Symbol	Parameter	$T_A = +25^\circ\text{C}$ $C_L = 50\text{ pF}$ $V_{CCA} = 2.7\text{V}-3.6\text{V}$ $V_{CCB} = 4.5\text{V}-5.5\text{V}$			$T_A = -40^\circ\text{C to }+85^\circ\text{C}$ $C_L = 50\text{ pF}$ $V_{CCA} = 2.7\text{V}-3.6\text{V}$ $V_{CCB} = 4.5\text{V}-5.5\text{V}$		$T_A = +25^\circ\text{C}$ $C_L = 50\text{ pF}$ $V_{CCA} = 2.7\text{V}-3.6\text{V}$ $V_{CCB} = 3.0\text{V}-3.6\text{V}$			$T_A = -40^\circ\text{C to }+85^\circ\text{C}$ $C_L = 50\text{ pF}$ $V_{CCA} = 2.7\text{V}-3.6\text{V}$ $V_{CCB} = 3.0\text{V}-3.6\text{V}$		Units
		Min	Typ (Note 6)	Max	Min	Max	Min	Typ (Note 7)	Max	Min	Max	
t_{PHL}	Propagation Delay A to B	1.0	4.8	8.0	1.0	8.5	1.0	5.5	8.5	1.0	9.0	ns
t_{PLH}		1.0	3.9	6.5	1.0	7.0	1.0	5.2	8.0	1.0	8.5	
t_{PHL}	Propagation Delay B to A	1.0	3.8	6.5	1.0	7.0	1.0	4.4	7.0	1.0	7.5	ns
t_{PLH}		1.0	4.3	7.5	1.0	8.0	1.0	5.1	7.5	1.0	8.0	
t_{PZL}	Output Enable Time $\overline{\text{OE}}$ to B	1.0	4.7	8.0	1.0	8.5	1.0	6.0	9.0	1.0	9.5	ns
t_{PZH}		1.0	4.8	8.5	1.0	9.0	1.0	6.1	9.5	1.0	10.0	
t_{PZL}	Output Enable Time $\overline{\text{OE}}$ to A	1.0	5.9	9.5	1.0	10.0	1.0	6.4	10.0	1.0	10.5	ns
t_{PZH}		1.0	5.4	9.0	1.0	9.5	1.0	5.8	9.0	1.0	9.5	
t_{PHZ}	Output Disable Time $\overline{\text{OE}}$ to B	1.0	4.0	8.0	1.0	8.5	1.0	6.3	9.5	1.0	10.0	ns
t_{PLZ}		1.0	3.8	7.5	1.0	8.0	1.0	4.5	8.0	1.0	8.5	
t_{PHZ}	Output Disable Time $\overline{\text{OE}}$ to A	1.0	4.6	9.5	1.0	10.0	1.0	5.2	9.5	1.0	10.0	ns
t_{PLZ}		1.0	3.1	6.5	1.0	7.0	1.0	3.4	6.5	1.0	7.0	
t_{OSHL}	Output to Output Skew (Note 8)		1.0	1.5		1.5		1.0	1.5		1.5	ns
t_{OSLH}	Data to Output											

Note 6: Typical values at $V_{CCA} = 3.3\text{V}$, $V_{CCB} = 5.0\text{V}$ @ 25°C .

Note 7: Typical values at $V_{CCA} = 3.3\text{V}$, $V_{CCB} = 3.3\text{V}$ @ 25°C .

Note 8: Skew is defined as the absolute value of the difference between the actual propagation delay for any two separate outputs of the same device. The specification applies to any outputs switching in the same direction, either HIGH-to-LOW (t_{OSHL}) or LOW-to-HIGH (t_{OSLH}). Parameter guaranteed by design.

Capacitance

Symbol	Parameter	Typ	Units	Conditions	
C_{IN}	Input Capacitance	4.5	pF	$V_{CC} = \text{Open}$	
$C_{I/O}$	Input/Output Capacitance	10	pF	$V_{CCA} = 3.3\text{V}$ $V_{CCB} = 5.0\text{V}$	
C_{PD}	Power Dissipation Capacitance (Note 9)	A→B	50	pF	$V_{CCB} = 5.0\text{V}$
		B→A	40	pF	$V_{CCA} = 3.3\text{V}$

Note 9: C_{PD} is measured at 10 MHz.

Power Up Considerations

To insure the system does not experience unnecessary I_{CC} current draw, bus contention, or oscillations during power up, the following guidelines should be adhered to (refer to Table 1):

- Power up the control side of the device first. This is the V_{CCA} side.
- \overline{OE} should ramp with or ahead of V_{CCA} . This will help guard against bus contention.
- The Transmit/Receive control pin (T/\overline{R}) should ramp with V_{CCA} , this will ensure that the A Port data pins are con-

figured as inputs. With V_{CCA} receiving power first, the A I/O Port should be configured as inputs to help guard against bus contention and oscillations.

- A side data inputs should be driven to a valid logic level. This will prevent excessive current draw.

The above steps will ensure that no bus contention or oscillations, and therefore no excessive current draw occurs during the power up cycling of these devices. These steps will help prevent possible damage to the translator devices and potential damage to other system components.

TABLE 1. Low Voltage Translator Power Up Sequencing Table

Device Type	V_{CCA}	V_{CCB}	T/\overline{R}	\overline{OE}	A Side I/O	B Side I/O	Floatable Pin Allowed
74LVXC3245	3V (power up 1st)	3V to 5.5V configurable	ramp with V_{CCA}	ramp with V_{CCA}	logic 0V or V_{CCA}	outputs	yes, V_{CCB} and B I/O's w/ \overline{OE} HIGH

Please reference Application Note AN-5001 for more detailed information on using Fairchild's LVX Low Voltage Dual Supply CMOS Translating Transceivers.

Configurable I/O Application for PCMCIA Cards

Block Diagram

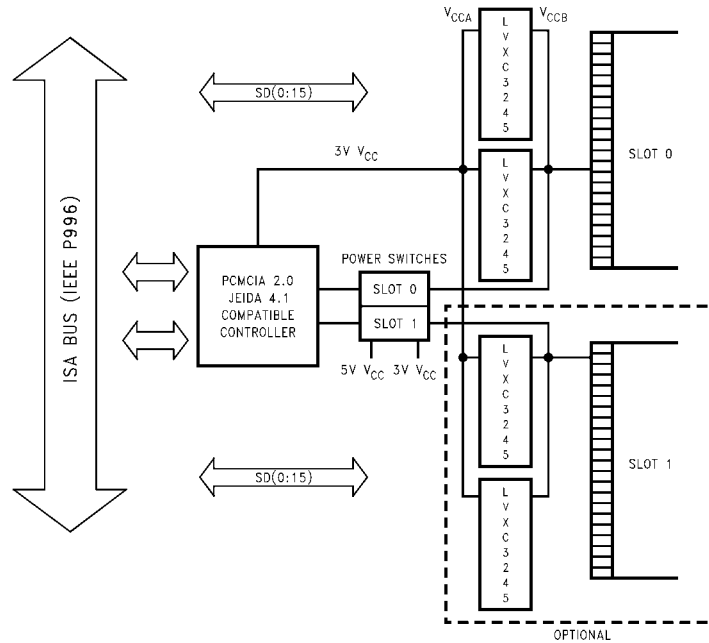

The LVXC3245 is a 24-pin dual supply device well suited for PCMCIA configurable I/O applications. Ideal for low power notebook designs, the LVXC3245 consumes less than 1 mW of quiescent power in all modes of operation. The LVXC3245 meets all PCMCIA I/O voltage requirements at 5V and 3.3V operation. By tying V_{CCB} of the LVXC3245 to the card voltage supply, the PCMCIA card

will always experience rail to rail output swings, maximizing the reliability of the interface.

The V_{CCA} pin on the LVXC3245 must always be tied to a 3V power supply. This voltage connection provides internal references needed to account for variations in V_{CCB} . When connected as in the figure above, the LVXC3245 meets all the voltage and current requirements of the ISA bus standard (IEEE P996).

Physical Dimensions inches (millimeters) unless otherwise noted

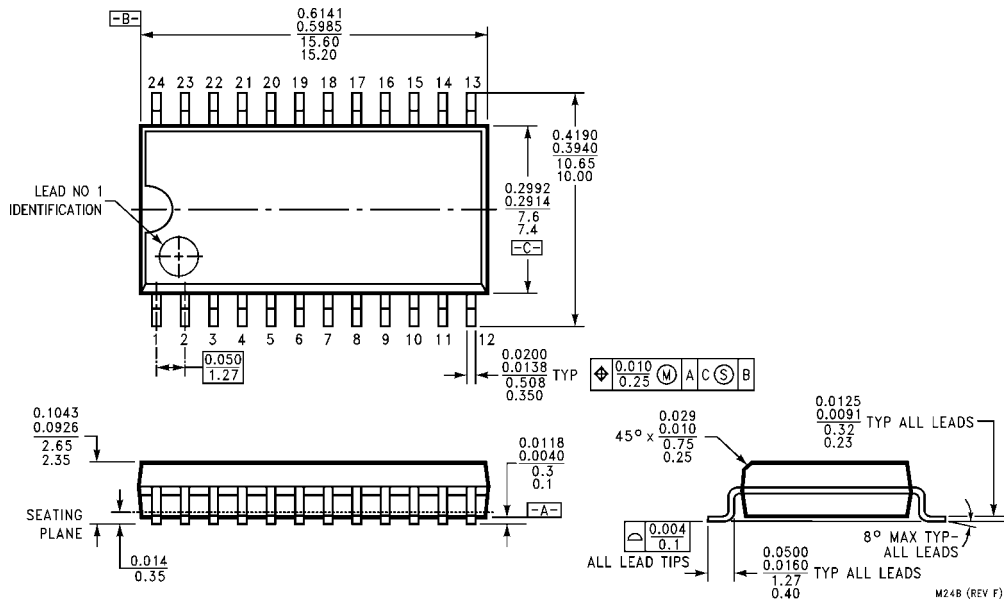

**24-Lead Small Outline Integrated Circuit (SOIC), JEDEC MS-013, 0.300" Wide
Package Number M24B**

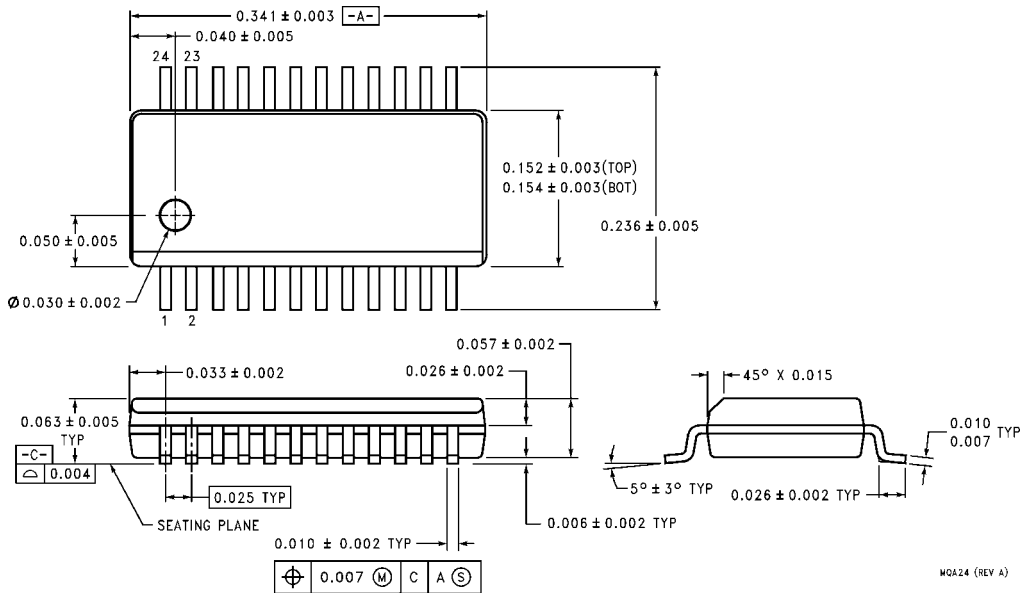

**24-Lead Quarter Size Outline Package (QSOP), JEDEC MO-37, 0.150" Wide
Package Number MQA24**

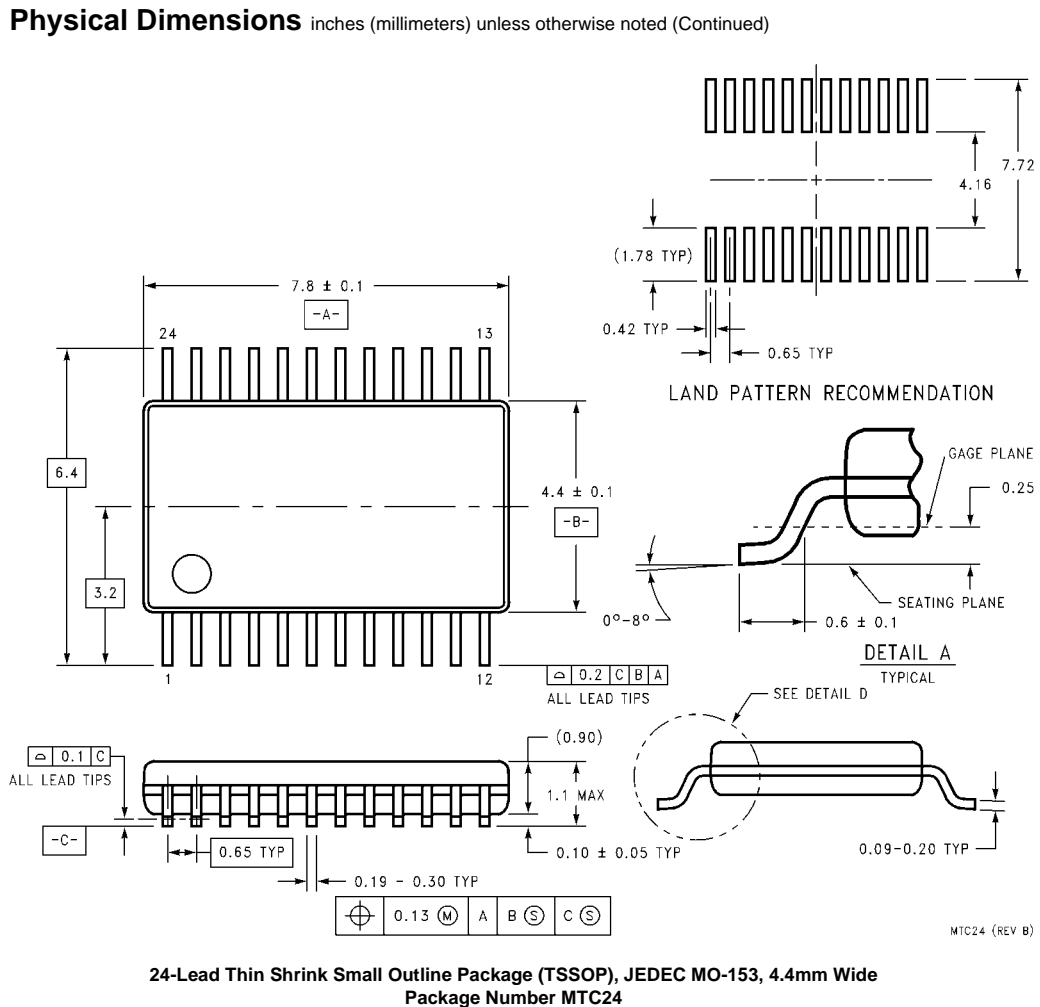

Fairchild does not assume any responsibility for use of any circuitry described, no circuit patent licenses are implied and Fairchild reserves the right at any time without notice to change said circuitry and specifications.

LIFE SUPPORT POLICY

FAIRCHILD'S PRODUCTS ARE NOT AUTHORIZED FOR USE AS CRITICAL COMPONENTS IN LIFE SUPPORT DEVICES OR SYSTEMS WITHOUT THE EXPRESS WRITTEN APPROVAL OF THE PRESIDENT OF FAIRCHILD SEMICONDUCTOR CORPORATION. As used herein:

1. Life support devices or systems are devices or systems which, (a) are intended for surgical implant into the body, or (b) support or sustain life, and (c) whose failure to perform when properly used in accordance with instructions for use provided in the labeling, can be reasonably expected to result in a significant injury to the user.
2. A critical component in any component of a life support device or system whose failure to perform can be reasonably expected to cause the failure of the life support device or system, or to affect its safety or effectiveness.

www.fairchildsemi.com