

74VCX16245

Low Voltage 16-Bit Bidirectional Transceiver with 3.6V Tolerant Inputs and Outputs

General Description

The VCX16245 contains sixteen non-inverting bidirectional buffers with 3-STATE outputs and is intended for bus oriented applications. The device is byte controlled. Each byte has separate 3-STATE control inputs which can be shorted together for full 16-bit operation. The T/\bar{R} inputs determine the direction of data flow through the device. The \overline{OE} inputs disable both the A and B ports by placing them in a high impedance state.

The 74VCX16245 is designed for low voltage (1.65 to 3.6V) V_{CC} applications with I/O compatibility up to 3.6V.

The 74VCX16245 is fabricated with an advanced CMOS technology to achieve high speed operation while maintaining low CMOS power dissipation.

Features

- 1.65V–3.6V V_{CC} supply operation
- 3.6V tolerant inputs and outputs
- t_{PD}
 - 2.5 ns max for 3.0V to 3.6V V_{CC}
 - 3.0 ns max for 2.3V to 2.7V V_{CC}
 - 6.0 ns max for 1.65V to 1.95V V_{CC}
- Power-down high impedance inputs and outputs
- Supports live insertion/withdrawal (Note 1)
- Static Drive (I_{OH}/I_{OL})
 - ±24 mA @ 3.0V V_{CC}
 - ±18 mA @ 2.3V V_{CC}
 - ±6 mA @ 1.65V V_{CC}
- Uses patented noise/EMI reduction circuitry
- Latchup performance exceeds 300 mA
- ESD performance:
 - Human body model > 2000V
 - Machine model > 200V

Note 1: To ensure the high-impedance state during power up or power down, \overline{OE} should be tied to V_{CC} through a pull-up resistor; the minimum value of the resistor is determined by the current-sourcing capability of the driver.

Ordering Code:

Order Number	Package Number	Package Description
74VCX16245MTD	MTD48	48-Lead Thin Shrink Small Outline Package (TSSOP), JEDEC MO-153, 6.1mm Wide

Devices also available in Tape and Reel. Specify by appending the suffix letter "X" to the ordering code.

Logic Symbol

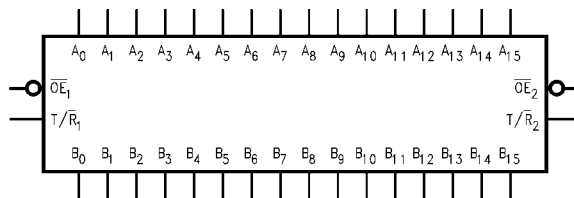

Connection Diagram

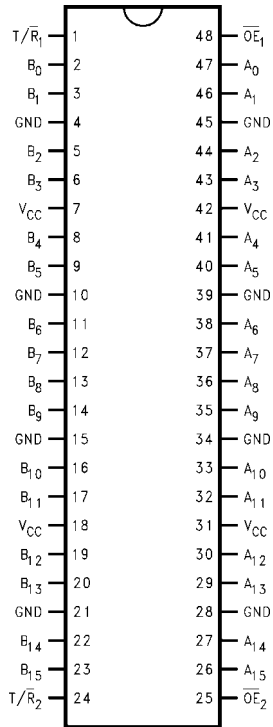

Pin Descriptions

Pin Names	Description
\overline{OE}_n	Output Enable Input (Active LOW)
T/\overline{R}_n	Transmit/Receive Input
A_0-A_{15}	Side A Inputs or 3-STATE Outputs
B_0-B_{15}	Side B Inputs or 3-STATE Outputs

Truth Tables

Inputs		Outputs
\overline{OE}_1	T/\overline{R}_1	
L	L	Bus B_0-B_7 Data to Bus A_0-A_7
L	H	Bus A_0-A_7 Data to Bus B_0-B_7
H	X	HIGH Z State on A_0-A_7, B_0-B_7

Inputs		Outputs
\overline{OE}_2	T/\overline{R}_2	
L	L	Bus B_8-B_{15} Data to Bus A_8-A_{15}
L	H	Bus A_8-A_{15} Data to Bus B_8-B_{15}
H	X	HIGH Z State on A_8-A_{15}, B_8-B_{15}

H = HIGH Voltage Level
 L = LOW Voltage Level
 X = Immaterial (HIGH or LOW, inputs and I/O's may not float)
 Z = High Impedance

Logic Diagram

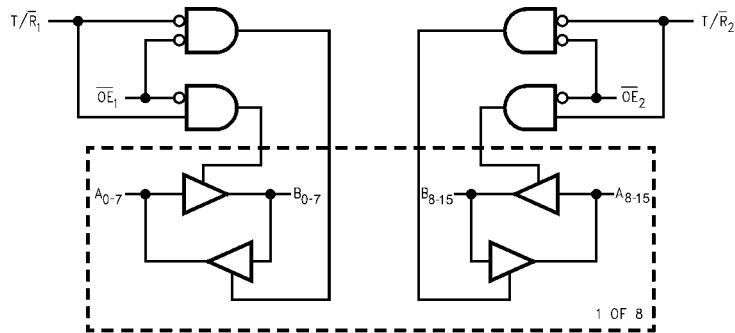

Absolute Maximum Ratings (Note 2)		Recommended Operating Conditions (Note 4)	
Supply Voltage (V_{CC})	-0.5V to +4.6V	Power Supply	
DC Input Voltage (V_I)	-0.5V to +4.6V	Operating	1.65V to 3.6V
Output Voltage (V_O)		Data Retention Only	1.2V to 3.6V
Outputs 3-STATE	-0.5V to +4.6V	Input Voltage	-0.3V to 3.6V
Outputs Active (Note 3)	-0.5 to $V_{CC} + 0.5V$	Output Voltage (V_O)	
DC Input Diode Current (I_{IK}) $V_I < 0V$	-50 mA	Output in Active States	0V to V_{CC}
DC Output Diode Current (I_{OK})		Output in 3-STATE	0.0V to 3.6V
$V_O < 0V$	-50 mA	Output Current in I_{OH}/I_{OL}	
$V_O > V_{CC}$	+50 mA	$V_{CC} = 3.0V$ to 3.6V	± 24 mA
DC Output Source/Sink Current		$V_{CC} = 2.3V$ to 2.7V	± 18 mA
(I_{OH}/I_{OL})	± 50 mA	$V_{CC} = 1.65V$ to 2.3V	± 6 mA
DC V_{CC} or Ground Current per		Free Air Operating Temperature (T_A)	-40°C to +85°C
Supply Pin (I_{CC} or Ground)	± 100 mA	Minimum Input Edge Rate ($\Delta t/\Delta V$)	
Storage Temperature Range (T_{STG})	-65°C to +150°C	$V_{IN} = 0.8V$ to 2.0V, $V_{CC} = 3.0V$	10 ns/V

Note 2: The "Absolute Maximum Ratings" are those values beyond which the safety of the device cannot be guaranteed. The device should not be operated at these limits. The parametric values defined in the "Electrical Characteristics" table are not guaranteed at the Absolute Maximum Ratings. The Recommended Operating Conditions tables will define the conditions for actual device operation.

Note 3: I_O Absolute Maximum Rating must be observed.

Note 4: Floating or unused pin (inputs or I/O's) must be held HIGH or LOW.

DC Electrical Characteristics (2.7V < V_{CC} ≤ 3.6V)

Symbol	Parameter	Conditions	V_{CC} (V)	Min	Max	Units
V_{IH}	HIGH Level Input Voltage		2.7-3.6	2.0		V
V_{IL}	LOW Level Input Voltage		2.7-3.6		0.8	V
V_{OH}	HIGH Level Output Voltage	$I_{OH} = -100 \mu A$ $I_{OH} = -12 \text{ mA}$ $I_{OH} = -18 \text{ mA}$ $I_{OH} = -24 \text{ mA}$	2.7-3.6 2.7 3.0 3.0	$V_{CC} - 0.2$ 2.2 2.4 2.2		V
V_{OL}	LOW Level Output Voltage	$I_{OL} = 100 \mu A$ $I_{OL} = 12 \text{ mA}$ $I_{OL} = 18 \text{ mA}$ $I_{OL} = 24 \text{ mA}$	2.7-3.6 2.7 3.0 3.0		0.2 0.4 0.4 0.55	V
I_I	Input Leakage Current	$0V \leq V_I \leq 3.6V$	2.7-3.6		± 5.0	μA
I_{OZ}	3-STATE Output Leakage	$0V \leq V_O \leq 3.6V$ $V_I = V_{IH}$ or V_{IL}	2.7-3.6		± 10	μA
I_{OFF}	Power Off Leakage Current	$0V \leq (V_I, V_O) \leq 3.6V$	0		10	μA
I_{CC}	Quiescent Supply Current	$V_I = V_{CC}$ or GND $V_{CC} \leq (V_I, V_O) \leq 3.6V$ (Note 5)	2.7-3.6 2.7-3.6		20 ± 20	μA
ΔI_{CC}	Increase in I_{CC} per Input	$V_{IH} = V_{CC} - 0.6V$	2.7-3.6		750	μA

Note 5: Outputs disabled or 3-STATE only.

DC Electrical Characteristics ($2.3V \leq V_{CC} \leq 2.7V$)						
Symbol	Parameter	Conditions	V _{CC} (V)	Min	Max	Units
V _{IH}	HIGH Level Input Voltage		2.3-2.7	1.6		V
V _{IL}	LOW Level Input Voltage		2.3-2.7		0.7	V
V _{OH}	HIGH Level Output Voltage	I _{OH} = -100 μA I _{OH} = -6 mA I _{OH} = -12 mA I _{OH} = -18 mA	2.3-2.7 2.3 2.3 2.3	V _{CC} - 0.2 2.0 1.8 1.7		V
V _{OL}	LOW Level Output Voltage	I _{OL} = 100 μA I _{OL} = 12 mA I _{OL} = 18 mA	2.3-2.7 2.3 2.3		0.2 0.4 0.6	V
I _I	Input Leakage Current	0 ≤ V _I ≤ 3.6V	2.3-2.7		±5.0	μA
I _{OZ}	3-STATE Output Leakage	0 ≤ V _O ≤ 3.6V V _I = V _{IH} or V _{IL}	2.3-2.7		±10	μA
I _{OFF}	Power Off Leakage Current	0 ≤ (V _I , V _O) ≤ 3.6V	0		10	μA
I _{CC}	Quiescent Supply Current	V _I = V _{CC} or GND V _{CC} ≤ (V _I , V _O) ≤ 3.6V (Note 6)	2.3-2.7 2.3-2.7		20 ±20	μA
Note 6: Outputs disabled or 3-STATE only.						
DC Electrical Characteristics ($1.65V \leq V_{CC} < 2.3V$)						
Symbol	Parameter	Conditions	V _{CC} (V)	Min	Max	Units
V _{IH}	HIGH Level Input Voltage		1.65-2.3	0.65 × V _{CC}		V
V _{IL}	LOW Level Input Voltage		1.65-2.3		0.35 × V _{CC}	V
V _{OH}	HIGH Level Output Voltage	I _{OH} = -100 μA I _{OH} = -6 mA	1.65-2.3 1.65	V _{CC} - 0.2 1.25		V
V _{OL}	LOW Level Output Voltage	I _{OL} = 100 μA I _{OL} = 6 mA	1.65-2.3 1.65		0.2 0.3	V
I _I	Input Leakage Current	0 ≤ V _I ≤ 3.6V	1.65-2.3		±5.0	μA
I _{OZ}	3-STATE Output Leakage	0 ≤ V _O ≤ 3.6V V _I = V _{IH} or V _{IL}	1.65-2.3		±10	μA
I _{OFF}	Power Off Leakage Current	0 ≤ (V _I , V _O) ≤ 3.6V	0		10	μA
I _{CC}	Quiescent Supply Current	V _I = V _{CC} or GND V _{CC} ≤ (V _I , V _O) ≤ 3.6V (Note 7)	1.65-2.3 1.65-2.3		20 ±20	μA
Note 7: Outputs disabled or 3-STATE only.						

AC Electrical Characteristics (Note 8)								
Symbol	Parameter	$T_A = -40^{\circ}\text{C to } +85^{\circ}\text{C}, C_L = 30 \text{ pF}, R_L = 500\Omega$						Units
		$V_{CC} = 3.3\text{V} \pm 0.3\text{V}$		$V_{CC} = 2.5 \pm 0.2\text{V}$		$V_{CC} = 1.8\text{V} \pm 0.15\text{V}$		
		Min	Max	Min	Max	Min	Max	
t_{PHL}, t_{PLH}	Prop Delay	0.8	2.5	1.0	3.0	1.5	6.0	ns
t_{PZL}, t_{PZH}	Output Enable Time	0.8	3.8	1.0	4.9	1.5	9.3	ns
t_{PLZ}, t_{PHZ}	Output Disable Time	0.8	3.7	1.0	4.2	1.5	7.6	ns
t_{OSHL} t_{OSLH}	Output to Output Skew (Note 9)		0.5		0.5		0.75	ns
<p>Note 8: For $C_L = 50\text{pF}$, add approximately 300ps to the AC maximum specification.</p> <p>Note 9: Skew is defined as the absolute value of the difference between the actual propagation delay for any two separate outputs of the same device. The specification applies to any outputs switching in the same direction, either HIGH-to-LOW (t_{OSHL}) or LOW-to-HIGH (t_{OSLH}).</p>								
Dynamic Switching Characteristics								
Symbol	Parameter	Conditions	V_{CC} (V)	$T_A = +25^{\circ}\text{C}$	Units			
				Typical				
V_{OLP}	Quiet Output Dynamic Peak V_{OL}	$C_L = 30 \text{ pF}, V_{IH} = V_{CC}, V_{IL} = 0\text{V}$	1.8	0.25	V			
			2.5	0.6				
			3.3	0.8				
V_{OLV}	Quiet Output Dynamic Valley V_{OL}	$C_L = 30 \text{ pF}, V_{IH} = V_{CC}, V_{IL} = 0\text{V}$	1.8	-0.25	V			
			2.5	-0.6				
			3.3	-0.8				
V_{OHV}	Quiet Output Dynamic Valley V_{OH}	$C_L = 30 \text{ pF}, V_{IH} = V_{CC}, V_{IL} = 0\text{V}$	1.8	1.5	V			
			2.5	1.9				
			3.3	2.2				
Capacitance								
Symbol	Parameter	Conditions	$T_A = +25^{\circ}\text{C}$	Units				
C_{IN}	Input Capacitance	$V_{CC} = 1.8\text{V}, 2.5\text{V}, \text{ or } 3.3\text{V}, V_I = 0\text{V or } V_{CC}$	6	pF				
C_{IO}	Output Capacitance	$V_I = 0\text{V}, \text{ or } V_{CC}, V_{CC} = 1.8\text{V}, 2.5\text{V or } 3.3\text{V}$	7	pF				
C_{PD}	Power Dissipation Capacitance	$V_I = 0\text{V or } V_{CC}, F = 10 \text{ MHz}$ $V_{CC} = 1.8\text{V}, 2.5\text{V or } 3.3\text{V}$	20	pF				

AC Loading and Waveforms

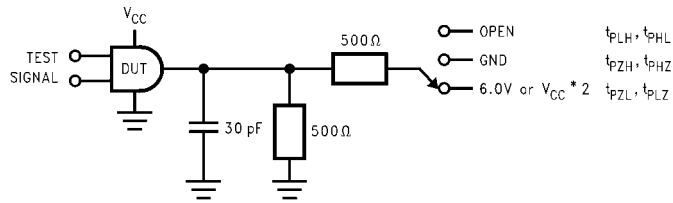

FIGURE 1. AC Test Circuit

TEST	SWITCH
t_{PLH} , t_{PHL}	Open
t_{PZL} , t_{PLZ}	6V at $V_{CC} = 3.3 \pm 0.3V$; $V_{CC} * 2$ at $V_{CC} = 2.5 \pm 0.2V$; $1.8V \pm 0.15V$
t_{PZH} , t_{PHZ}	GND

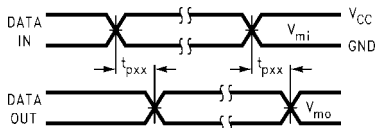

FIGURE 2. Waveform for Inverting and Non-inverting Functions

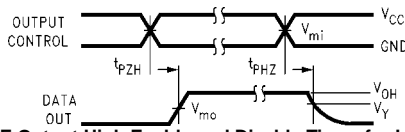

FIGURE 3. 3-STATE Output High Enable and Disable Times for Low Voltage Logic

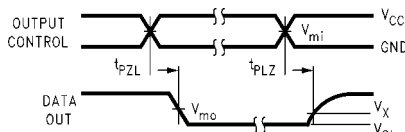

FIGURE 4. 3-STATE Output Low Enable and Disable Times for Low Voltage Logic

Symbol	V_{CC}		
	$3.3V \pm 0.3V$	$2.5V \pm 0.2V$	$1.8V \pm 0.15V$
V_{mi}	1.5V	$V_{CC}/2$	$V_{CC}/2$
V_{mo}	1.5V	$V_{CC}/2$	$V_{CC}/2$
V_X	$V_{OL} + 0.3V$	$V_{OL} + 0.15V$	$V_{OL} + 0.15V$
V_Y	$V_{OH} - 0.3V$	$V_{OH} - 0.15V$	$V_{OH} - 0.15V$

