

74VHC153 Dual 4-Input Multiplexer

General Description

The VHC153 is an advanced high-speed CMOS device fabricated with silicon gate CMOS technology. It achieves the high-speed operation similar to equivalent Bipolar Schottky TTL while maintaining the CMOS low power dissipation. The VHC153 is a high-speed Dual 4-Input Multiplexer with common select inputs and individual enable inputs for each section. It can select two lines of data from four sources. The two buffered outputs present data in the true (non-inverted) form. In addition to multiplexer operation, the VHC153 can act as a function generator and generate any two functions of three variables. An input protection circuit insures that 0V to 7V can be applied to the input pins without regard to the supply voltage. This

device can be used to interface 5V to 3V systems and two supply systems such as battery backup. This circuit prevents device destruction due to mismatched supply and input voltages.

Features

- High Speed: $t_{PD} = 5.0$ ns at $T_A = 25^\circ\text{C}$
- Low power dissipation: $I_{CC} = 4$ μA (max) at $T_A = 25^\circ\text{C}$
- High noise immunity: $V_{NIH} = V_{NIL} = 28\%$ V_{CC} (min)
- Power down protection is provided on all inputs
- Pin and function compatible with 74HC153

Ordering Code:

Order Number	Package Number	Package Description
74VHC153M	M16A	16-Lead Small Outline Integrated Circuit (SOIC), JEDEC MS-012, 0.150 Narrow
74VHC153SJ	M16D	16-Lead Small Outline Package (SOP), EIAJ TYPE II, 5.3mm Wide
74VHC153MTC	MTC16	16-Lead Thin Shrink Small Outline Package (TSSOP), JEDEC MO-153, 4.4mm Wide
74VHC153N	N16E	16-Lead Plastic Dual-In-Line Package (PDIP), JEDEC MS-001, 0.300 Wide

Surface mount packages are also available on Tape and Reel. Specify by appending the suffix letter "X" to the ordering code.

Logic Symbols

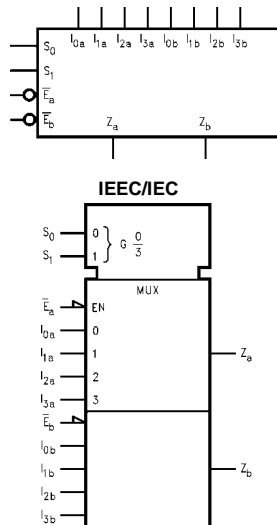

Connection Diagram

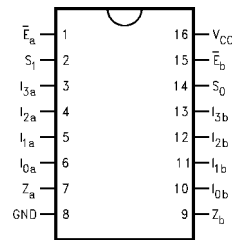

Pin Descriptions

Pin Names	Description
I_{0a} – I_{3a}	Side A Data Inputs
I_{0b} – I_{3b}	Side B Data Inputs
S_0, S_1	Common Select Inputs
\bar{E}_a	Side A Enable Input
\bar{E}_b	Side B Enable Input
Z_a	Side A Output
Z_b	Side B Output

Functional Description

The VHC153 is a dual 4-input multiplexer. It can select two bits of data from up to four sources under the control of the common Select inputs (S_0, S_1). The two 4-input multiplexer circuits have individual active-LOW Enables (\bar{E}_a, \bar{E}_b) which can be used to strobe the outputs independently. When the Enables (\bar{E}_a, \bar{E}_b) are HIGH, the corresponding outputs (Z_a, Z_b) are forced LOW. The VHC153 is the logic implementation of a 2-pole, 4-position switch, where the position of the switch is determined by the logic levels supplied to the Select inputs. The logic equations for the outputs are shown below.

$$Z_a = \bar{E}_a \cdot (I_{0a} \cdot \bar{S}_1 \cdot \bar{S}_0 + I_{1a} \cdot \bar{S}_1 \cdot S_0 + I_{2a} \cdot S_1 \cdot S_0 + I_{3a} \cdot S_1 \cdot \bar{S}_0)$$

$$Z_b = \bar{E}_b \cdot (I_{0b} \cdot \bar{S}_1 \cdot \bar{S}_0 + I_{1b} \cdot \bar{S}_1 \cdot S_0 + I_{2b} \cdot S_1 \cdot S_0 + I_{3b} \cdot S_1 \cdot \bar{S}_0)$$

Truth Table

Select Inputs		\bar{E}	Inputs (a or b)				Output Z
S_0	S_1		I_0	I_1	I_2	I_3	
X	X	H	X	X	X	X	L
L	L	L	L	X	X	X	L
L	L	L	H	X	X	X	H
H	L	L	X	L	X	X	L
H	L	L	X	H	X	X	H
L	H	L	X	X	L	X	L
L	H	L	X	X	H	X	H
H	H	L	X	X	X	L	L
H	H	L	X	X	X	H	H

H = HIGH Voltage Level
 L = LOW Voltage Level
 X = Immaterial

Logic Diagram

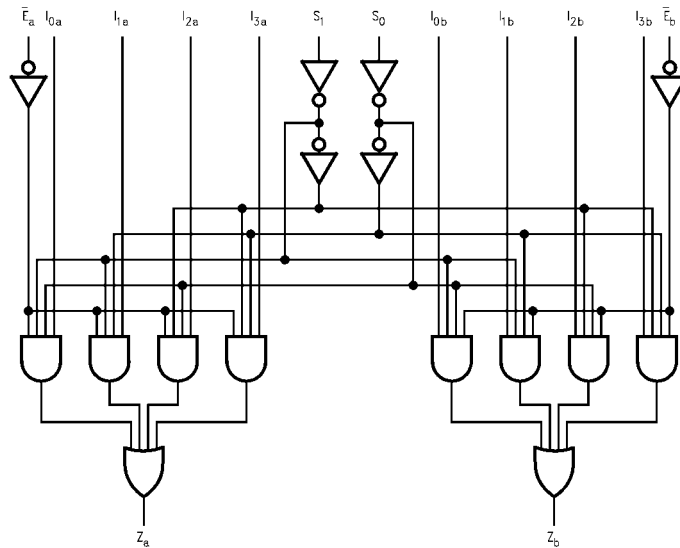

Please note that this diagram is provided only for the understanding of logic operations and should not be used to estimate propagation delays.

Absolute Maximum Ratings (Note 1)

Supply Voltage (V_{CC})	-0.5V to +7.0V
DC Input Voltage (V_{IN})	-0.5V to +7.0V
DC Output Voltage (V_{OUT})	-0.5V to $V_{CC} + 0.5V$
Input Diode Current (I_{IK})	-20 mA
Output Diode Current (I_{OK})	± 20 mA
DC Output Current (I_{OUT})	± 25 mA
DC V_{CC} /GND Current (I_{CC})	± 50 mA
Storage Temperature (T_{STG})	-65°C to +150°C
Lead Temperature (T_L) (Soldering, 10 seconds)	260°C

Recommended Operating Conditions (Note 2)

Supply Voltage (V_{CC})	2.0V to 5.5V
Input Voltage (V_{IN})	0V to +5.5V
Output Voltage (V_{OUT})	0V to V_{CC}
Operating Temperature (T_{OPR})	-40°C to +85°C
Input Rise and Fall Time (t_r, t_f)	
$V_{CC} = 3.3V \pm 0.3V$	0-100 ns/V
$V_{CC} = 5.0V \pm 0.5V$	0-20 ns/V

Note 1: Absolute maximum ratings are those values beyond which the device may be damaged or have its useful life impaired. The databook specifications should be met, without exception, to ensure that the system design is reliable over its power supply, temperature, and output/input loading variables. Fairchild does not recommend operation outside databook specifications.

Note 2: Unused inputs must be held HIGH or LOW. They may not float.

DC Electrical Characteristics

Symbol	Parameter	V_{CC} (V)	$T_A = 25^\circ\text{C}$			$T_A = -40^\circ\text{C to } +85^\circ\text{C}$		Units	Conditions	
			Min	Typ	Max	Min	Max			
V_{IH}	HIGH Level Input Voltage	2.0 3.0 - 5.5	1.50 0.7 V_{CC}			1.50 0.7 V_{CC}		V		
V_{IL}	LOW Level Input Voltage	2.0 3.0 - 5.5			0.50 0.3 V_{CC}	0.50 0.3 V_{CC}		V		
V_{OH}	HIGH Level Output Voltage	2.0	1.9	2.0		1.9		V	$V_{IN} = V_{IH}$ or V_{IL}	$I_{OH} = -50 \mu\text{A}$
		3.0	2.9	3.0		2.9				
		4.5	4.4	4.5		4.4		V		$I_{OH} = -4 \text{ mA}$ $I_{OH} = -8 \text{ mA}$
		3.0	2.58			2.48				
4.5	3.94			3.80						
V_{OL}	LOW Level Output Voltage	2.0		0.0	0.1		0.1	V	$V_{IN} = V_{IH}$ or V_{IL}	$I_{OL} = 50 \mu\text{A}$
		3.0		0.0	0.1		0.1			
		4.5		0.0	0.1		0.1	V		$I_{OL} = 4 \text{ mA}$ $I_{OL} = 8 \text{ mA}$
		3.0			0.36		0.44			
4.5			0.36		0.44					
I_{IN}	Input Leakage Current	0 - 5.5			± 0.1	± 1.0		μA	$V_{IN} = 5.5V$ or GND	
I_{CC}	Quiescent Supply Current	5.5			4.0	40.0		μA	$V_{IN} = V_{CC}$ or GND	

AC Electrical Characteristics

Symbol	Parameter	V _{CC} (V)	T _A = 25°C			T _A = -40°C to +85°C		Units	Conditions
			Min	Typ	Max	Min	Max		
t _{PLH}	Propagation Delay I _n to Z _n	3.3 ± 0.3	7.7	11.9	1.0	14.0	ns	C _L = 15 pF	
t _{PHL}			10.2	15.4	1.0	17.5		C _L = 50 pF	
		5.0 ± 0.5	5.0	7.7	1.0	9.0	ns	C _L = 15 pF	
			6.5	9.7	1.0	11.0		C _L = 50 pF	
t _{PLH}	Propagation Delay S _n to Z _n	3.3 ± 0.3	10.8	16.7	1.0	19.5	ns	C _L = 15 pF	
t _{PHL}			13.3	20.2	1.0	23.0		C _L = 50 pF	
		5.0 ± 0.5	6.8	9.9	1.0	11.5	ns	C _L = 15 pF	
			8.3	11.9	1.0	13.5		C _L = 50 pF	
t _{PLH}	Propagation Delay E _n to Z _n	3.3 ± 0.3	6.3	10.1	1.0	12.0	ns	C _L = 15 pF	
t _{PHL}			8.8	13.6	1.0	15.5		C _L = 50 pF	
		5.0 ± 0.5	4.4	6.4	1.0	7.5	ns	C _L = 15 pF	
			5.9	8.4	1.0	9.5		C _L = 50 pF	
C _{IN}	Input Capacitance		4	10		10	pF	V _{CC} = Open	
C _{PD}	Power Dissipation Capacitance		20				pF	(Note 3)	

Note 3: C_{PD} is defined as the value of the internal equivalent capacitance which is calculated from the operating current consumption without load. Average operating current can be obtained by the equation: I_{CC (opr.)} = C_{PD} * V_{CC} * f_{IN} + I_{CC}.

Physical Dimensions inches (millimeters) unless otherwise noted

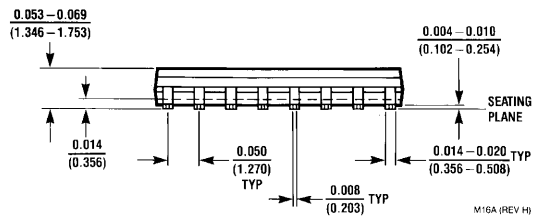
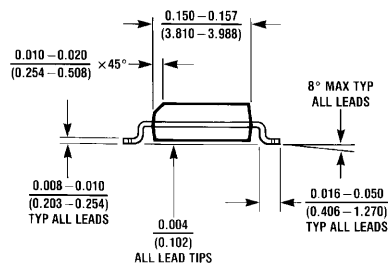
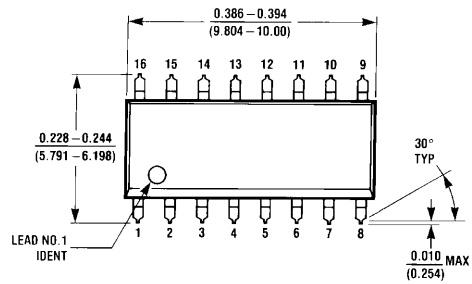

16-Lead Small Outline Integrated Circuit (SOIC), JEDEC MS-012, 0.150 Narrow Package Number M16A

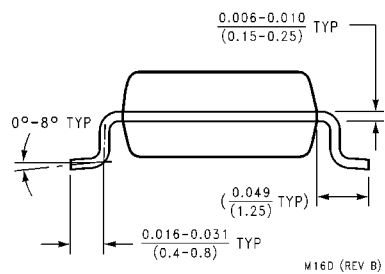
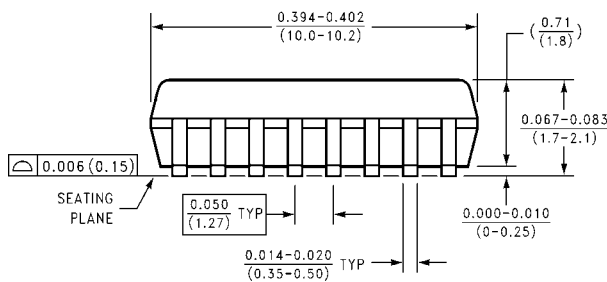
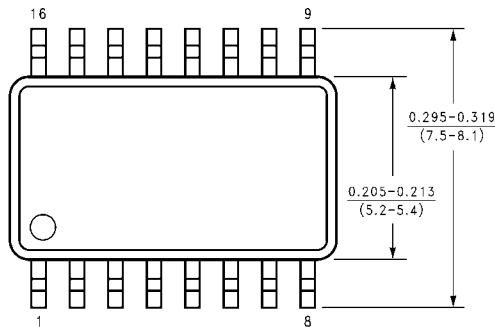

16-Lead Small Outline Package (SOP), EIAJ TYPE II, 5.3mm Wide Package Number M16D

Physical Dimensions inches (millimeters) unless otherwise noted (Continued)

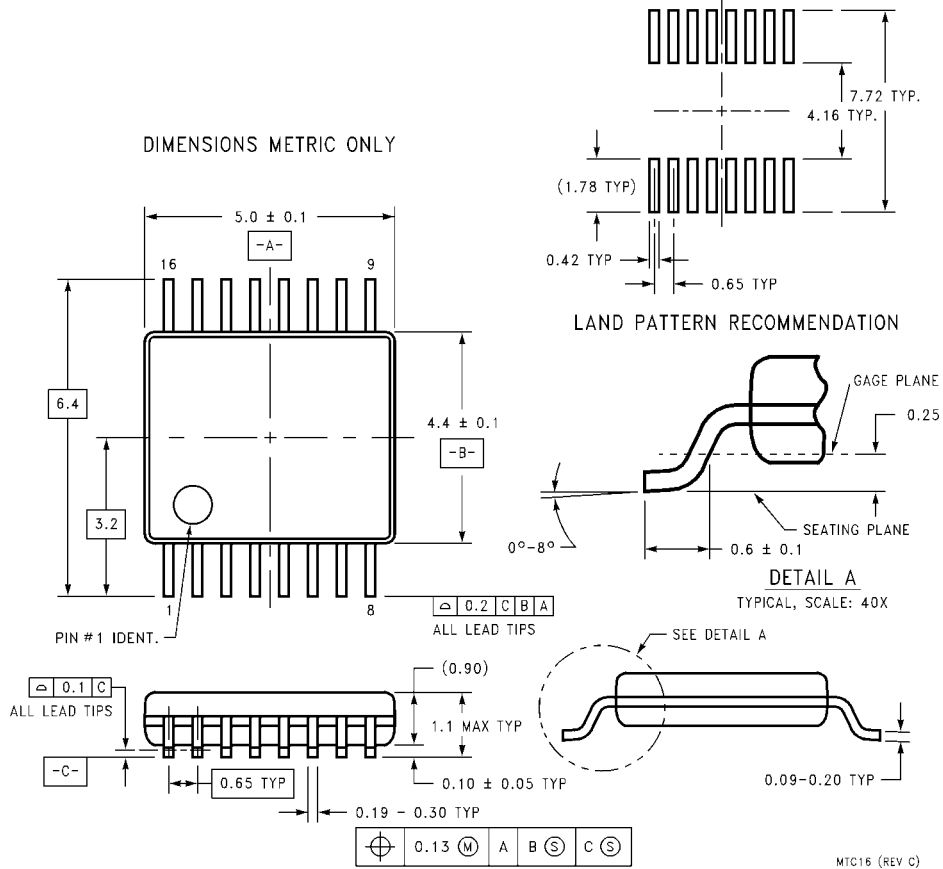

**16-Lead Thin Shrink Small Outline Package (TSSOP), JEDEC MO-153, 4.4mm Wide
Package Number MTC16**

