

74VHC393 Dual 4-Bit Binary Counter

General Description

The VHC393 is an advanced high speed CMOS 4-bit Binary Counter fabricated with silicon gate CMOS technology. It achieves the high speed operation similar to equivalent Bipolar Schottky TTL while maintaining the CMOS low power dissipation. It contains two independent counter circuits in one package, so that counting or frequency division of 8 binary bits can be achieved with one IC. This device changes state on the negative going transition of the CLOCK pulse. The counter can be reset to "0" ($Q_0-Q_3 = "L"$) by a HIGH at the CLEAR input regardless of other inputs.

An input protection circuit ensures that 0V to 7V can be applied to the input pins without regard to the supply volt-

age. This device can be used to interface 5V to 3V systems and two supply systems such as battery back up. This circuit prevents device destruction due to mismatched supply and input voltages.

Features

- High Speed: $f_{MAX} = 170$ MHz (typ) at $T_A = 25^\circ\text{C}$
- Low power dissipation: $I_{CC} = 4$ μA (max) at $T_A = 25^\circ\text{C}$
- High noise immunity: $V_{NIH} = V_{NIL} = 28\%$ V_{CC} (min)
- Power down protection is provided on all inputs
- Pin and function compatible with 74HC393

Ordering Code:

Order Number	Package Number	Package Description
74VHC393M	M14A	14-Lead Small Outline Integrated Circuit (SOIC), JEDEC MS-120, 0.150" Narrow
74VHC393SJ	M14D	14-Lead Small Outline Package (SOP), EIAJ TYPE II, 5.3mm Wide
74VHC393MTC	MTC14	14-Lead Thin Shrink Small Outline Package (TSSOP), JEDEC MO-153, 4.4mm Wide
74VHC393N	N14A	14-Lead Plastic Dual-In-Line Package (PDIP), JEDEC MS-001, 0.300 Wide

Surface mount packages are also available on Tape and Reel. Specify by appending the suffix letter "X" to the ordering code.

Logic Symbol

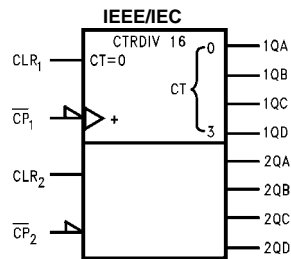

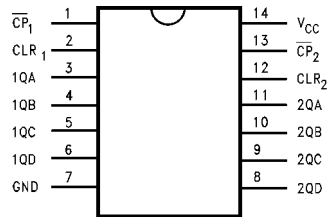

Connection Diagram



Pin Descriptions

Pin Names	Description
CLR1, CLR2	Clear Inputs
$\overline{CP}_1, \overline{CP}_2$	Clock Pulse Inputs
QA, QB, QC, QD	Outputs

Truth Table

Inputs		Outputs			
\overline{CP}	CLR	QA	QB	QC	QD
X	H	L	L	L	L
	L	Count Up			
	L	No Change			

X: Don't Care

System Diagram

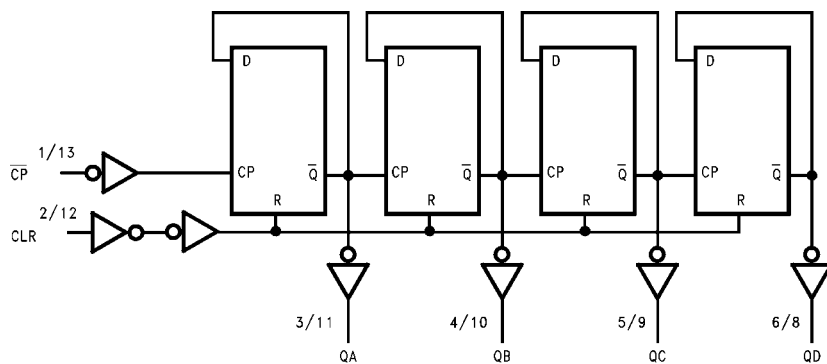

Timing Chart

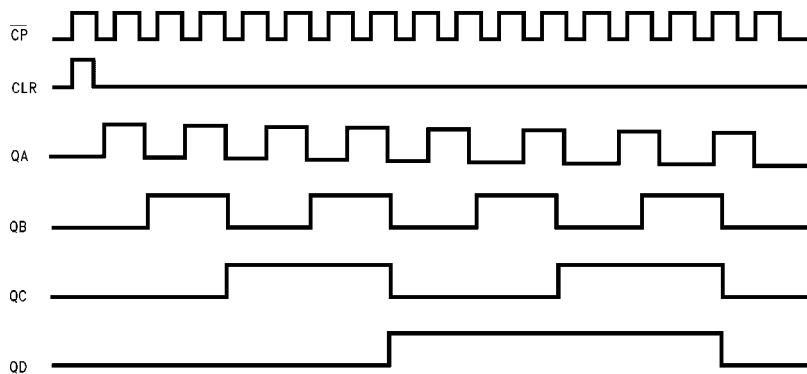

Absolute Maximum Ratings (Note 1)

Supply Voltage (V_{CC})	-0.5V to +7.0V
DC Input Voltage (V_{IN})	-0.5V to +7.0V
DC Output Voltage (V_{OUT})	-0.5V to $V_{CC} + 0.5V$
Input Diode Current (I_{IK})	-20 mA
Output Diode Current (I_{OK})	± 20 mA
DC Output Current (I_{OUT})	± 25 mA
DC V_{CC}/GND Current (I_{CC})	± 75 mA
Storage Temperature (T_{STG})	-65°C to +150°C
Lead Temperature (T_L) (Soldering, 10 seconds)	260°C

Recommended Operating Conditions (Note 2)

Supply Voltage (V_{CC})	2.0V to +5.5V
Input Voltage (V_{IN})	0V to +5.5V
Output Voltage (V_{OUT})	0V to V_{CC}
Operating Temperature (T_{OPR})	-40°C to +85°C
Input Rise and Fall Time (t_r, t_f)	
$V_{CC} = 3.3V \pm 0.3V$	0 ~ 100 ns/V
$V_{CC} = 5.0V \pm 0.5V$	0 ~ 20 ns/V

Note 1: Absolute Maximum Ratings are values beyond which the device may be damaged or have its useful life impaired. The databook specifications should be met, without exception, to ensure that the system design is reliable over its power supply, temperature, and output/input loading variables. Fairchild does not recommend operation outside databook specifications.

Note 2: Unused inputs must be held HIGH or LOW. They may not float.

DC Electrical Characteristics

Symbol	Parameter	V_{CC} (V)	$T_A = 25^\circ\text{C}$			$T_A = -40^\circ\text{C to } +85^\circ\text{C}$		Units	Conditions		
			Min	Typ	Max	Min	Max				
V_{IH}	HIGH Level	2.0	1.50			1.50		V			
	Input Voltage	3.0 – 5.5	$0.7 V_{CC}$			$0.7 V_{CC}$					
V_{IL}	LOW Level	2.0	0.50			0.50		V			
	Input Voltage	3.0 – 5.5	$0.3 V_{CC}$			$0.3 V_{CC}$					
V_{OH}	HIGH Level	2.0	1.9	2.0	1.9		V	$V_{IN} = V_{IH}$ or V_{IL}	$I_{OH} = -50 \mu\text{A}$		
		3.0	2.9	3.0	2.9						
	Output Voltage	4.5	4.4	4.5	4.4		V		$I_{OH} = -4 \text{ mA}$ $I_{OH} = -8 \text{ mA}$		
		3.0	2.58		2.48						
V_{OL}	LOW Level	2.0	0.0			0.1		V	$V_{IN} = V_{IH}$ or V_{IL}	$I_{OL} = 50 \mu\text{A}$	
		3.0	0.0			0.1					
	Output Voltage	4.5	0.0			0.1		V		$I_{OL} = 4 \text{ mA}$ $I_{OL} = 8 \text{ mA}$	
		3.0				0.36					
		4.5				0.36					
I_{IN}	Input Leakage Current	0 – 5.5				± 0.1		μA	$V_{IN} = 5.5V$ or GND		
I_{CC}	Quiescent Supply Current	5.5				4.0		μA	$V_{IN} = V_{CC}$ or GND		

AC Electrical Characteristics

Symbol	Parameter	V _{CC} (V)	T _A = 25°C			T _A = -40°C to +85°C		Units	Conditions
			Min	Typ	Max	Min	Max		
t _{PLH} t _{PHL}	Propagation Delay Time (CP-QA)	3.3 ± 0.3	8.6	13.2	1.0	15.5	ns	C _L = 15 pF	
		5.0 ± 0.5	11.1	16.7	1.0	19.0		C _L = 50 pF	
			5.8	8.5	1.0	10.0	ns	C _L = 15 pF	
			7.3	10.5	1.0	12.0		C _L = 50 pF	
t _{PLH} t _{PHL}	Propagation Delay Time (CP-QB)	3.3 ± 0.3	10.2	15.8	1.0	18.5	ns	C _L = 15 pF	
		5.0 ± 0.5	12.7	19.3	1.0	22.0		C _L = 50 pF	
			6.8	9.8	1.0	11.5	ns	C _L = 15 pF	
			8.3	11.8	1.0	13.5		C _L = 50 pF	
t _{PLH} t _{PHL}	Propagation Delay Time (CP-QC)	3.3 ± 0.3	11.7	18.0	1.0	21.0	ns	C _L = 15 pF	
		5.0 ± 0.5	14.2	21.5	1.0	24.5		C _L = 50 pF	
			7.7	11.2	1.0	13.0	ns	C _L = 15 pF	
			9.2	13.2	1.0	15.0		C _L = 50 pF	
t _{PLH} t _{PHL}	Propagation Delay Time (CP-QD)	3.3 ± 0.3	13.0	19.7	1.0	23.0	ns	C _L = 15 pF	
		5.0 ± 0.5	15.5	23.2	1.0	26.5		C _L = 50 pF	
			8.5	12.5	1.0	14.5	ns	C _L = 15 pF	
			10.0	14.5	1.0	16.5		C _L = 50 pF	
t _{PLH} t _{PHL}	Propagation Delay Time (CLR-Q _n)	3.3 ± 0.3	7.9	12.3	1.0	14.5	ns	C _L = 15 pF	
		5.0 ± 0.5	10.4	15.8	1.0	18.0		C _L = 50 pF	
			5.4	8.1	1.0	9.5	ns	C _L = 15 pF	
			6.9	10.1	1.0	11.5		C _L = 50 pF	
f _{MAX}	Maximum Clock	3.3 ± 0.3	75	120	65		MHz	C _L = 15 pF	
			45	65	35			C _L = 50 pF	
		5.0 ± 0.5	125	170	105			C _L = 15 pF	
			85	115	75			C _L = 50 pF	
C _{IN}	Input Capacitance		4	10	10		pF	V _{CC} = Open	
C _{PD}	Power Dissipation Capacitance		23				pF	(Note 3)	

Note 3: C_{PD} is defined as the value of the internal equivalent capacitance which is calculated from the operating current consumption without load Average operating current can be obtained by the equation: I_{CC(opr.)} = C_{PD} * V_{CC} * f_{IN} + I_{CC/2} (per Counter)

AC Operating Requirements

Symbol	Parameter	V _{CC} (V)	T _A = 25°C		T _A = -40°C to +85°C		Units
			Typ	Guaranteed Minimum			
t _{W(L)} t _{W(H)}	Minimum Pulse Width (CP)	3.3 ± 0.3 5.0 ± 0.5		5.0	5.0	5.0	ns
t _{W(H)}	Minimum Pulse Width (CLR)	3.3 ± 0.3 5.0 ± 0.5		5.0	5.0	5.0	
t _{REM}	Minimum Removal Time	3.3 ± 0.3 5.0 ± 0.5		5.0	5.0	4.0	ns

Physical Dimensions inches (millimeters) unless otherwise noted

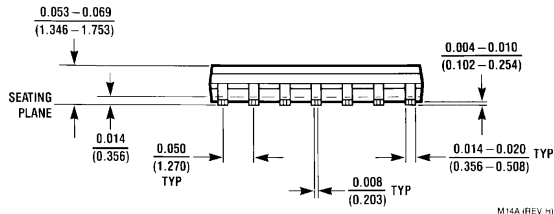
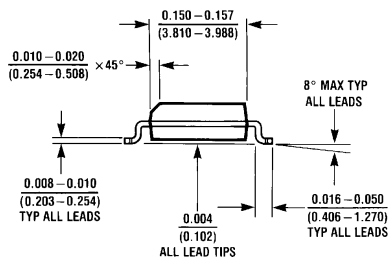
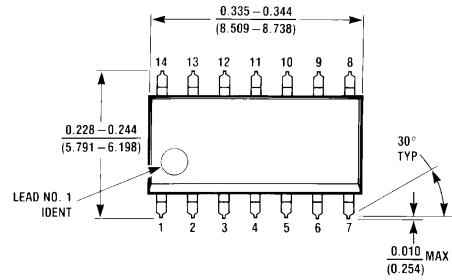

M14A (REV H)

**14-Lead Small Outline Integrated Circuit (SOIC), JEDEC MS-120, 0.150 Narrow
Package Number M14A**

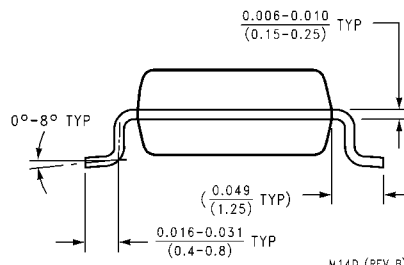
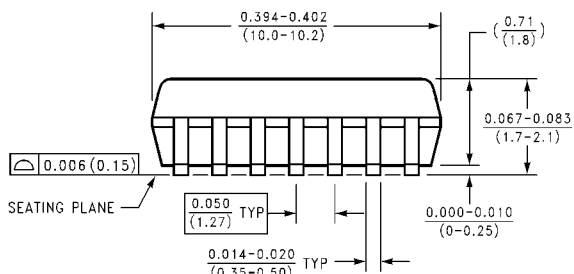
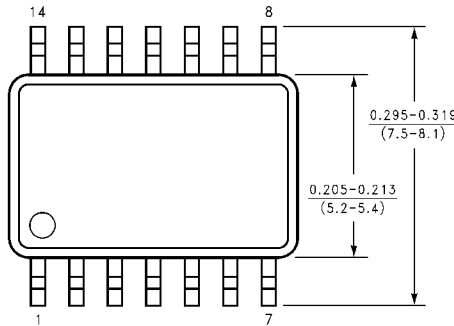

M14D (REV B)

**14-Lead Small Outline Package (SOP), EIAJ TYPE II, 5.3mm Wide
Package Number M14D**

Physical Dimensions inches (millimeters) unless otherwise noted (Continued)

14LD, TSSOP, JEDEC MO-153, 4.4MM WIDE

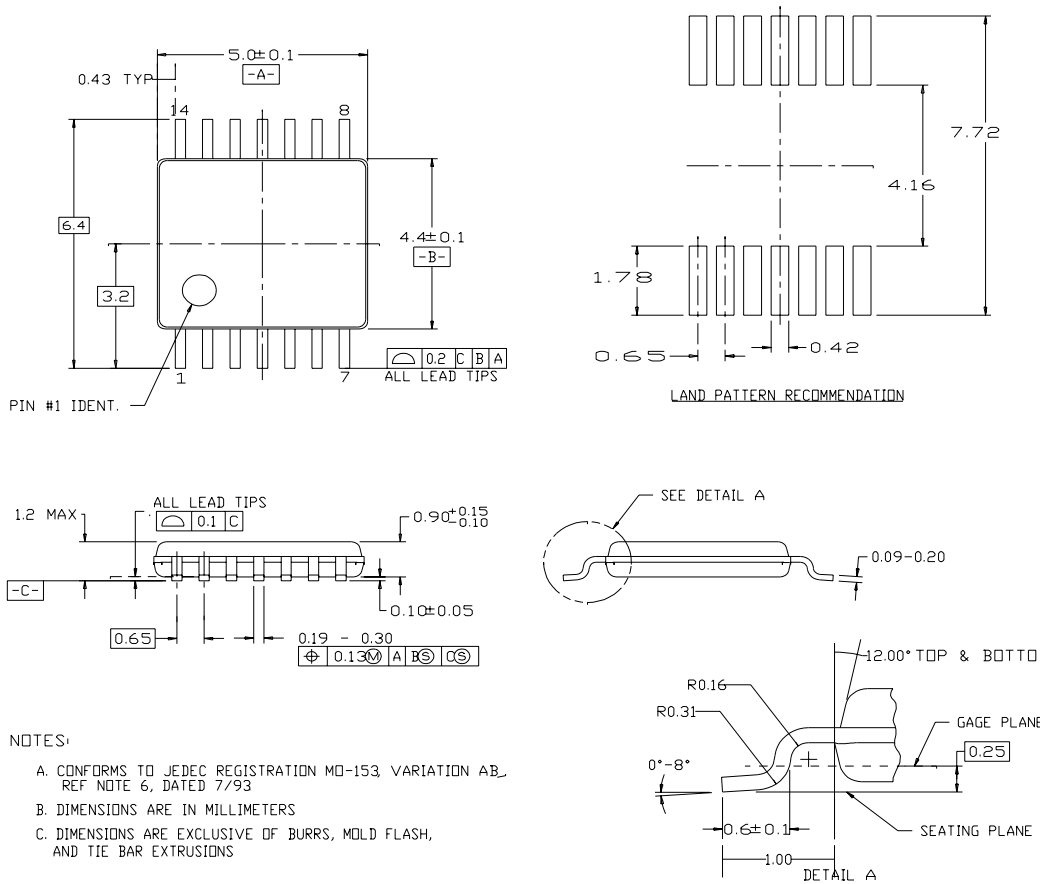

**14-Lead Thin Shrink Small Outline Package (TSSOP), JEDEC MO-153, 4.4mm Wide
Package Number MTC14**

Physical Dimensions inches (millimeters) unless otherwise noted (Continued)

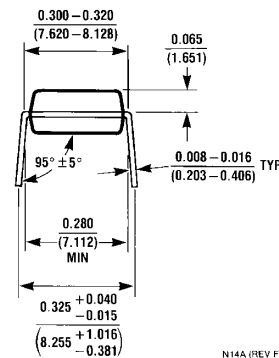
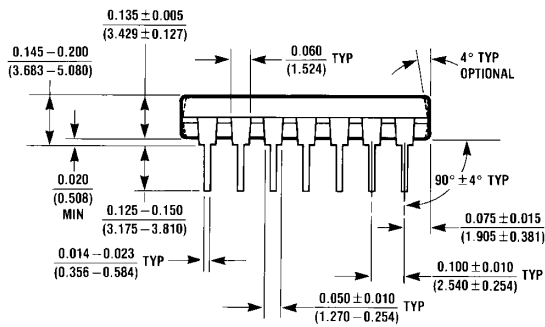
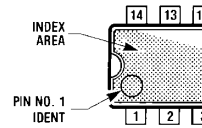
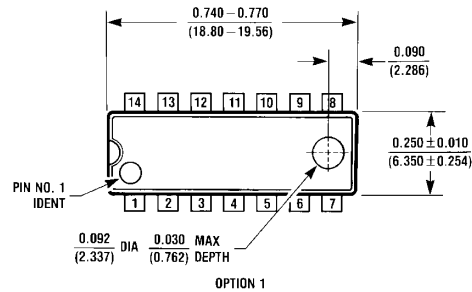

N14A (REV F)

14-Lead Plastic Dual-In-Line Package (PDIP), JEDEC MS-001, 0.300 Wide Package Number N14A

LIFE SUPPORT POLICY

FAIRCHILD'S PRODUCTS ARE NOT AUTHORIZED FOR USE AS CRITICAL COMPONENTS IN LIFE SUPPORT DEVICES OR SYSTEMS WITHOUT THE EXPRESS WRITTEN APPROVAL OF THE PRESIDENT OF FAIRCHILD SEMICONDUCTOR CORPORATION. As used herein:

1. Life support devices or systems are devices or systems which, (a) are intended for surgical implant into the body, or (b) support or sustain life, and (c) whose failure to perform when properly used in accordance with instructions for use provided in the labeling, can be reasonably expected to result in a significant injury to the user.
2. A critical component in any component of a life support device or system whose failure to perform can be reasonably expected to cause the failure of the life support device or system, or to affect its safety or effectiveness.

www.fairchildsemi.com