

THYRISTOR MODULE

AK25HB120/160



UL;E76102 (M)

Power Thyristor Module AK25HB series are designed for various rectifier circuits and power controls. For your circuit application, following internal connections and wide voltage ratings up to 1,600V are available, and electrically isolated mounting base make your mechanical design easy.

Isolated mounting base

- $I_{T(AV)}$ 25A, $I_{T(RMS)}$ 55A, I_{TSM} 500A
- di/dt 100 A/ μ s
- dv/dt 500V/ μ s

(Applications)

- AC/DC motor drives
- Heater controls
- Light dimmers
- Static switches

Internal Configurations

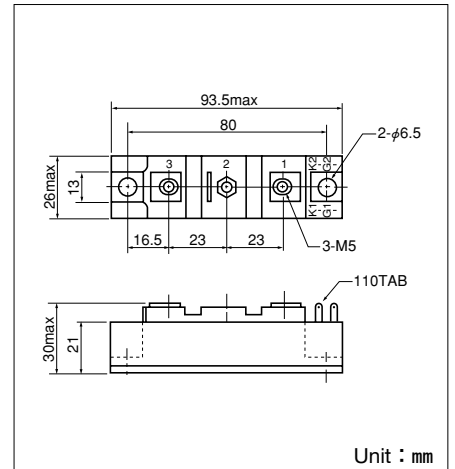
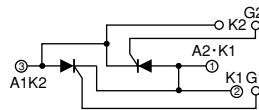

Maximum Ratings

($T_j=25^\circ\text{C}$ unless otherwise specified)

Symbol	Item	Ratings		Unit
		AK25HB120	AK25HB160	
V_{DRM}	Repetitive Peak Off-State Voltage	1200	1600	V

Symbol	Item	Conditions	Ratings	Unit	
$I_{T(AV)}$	Average On-State Current	Single phase, half wave, 180° conduction, $T_c : 94^\circ\text{C}$	25	A	
$I_{T(RMS)}$	R.M.S. On-State Current	$T_c : 94^\circ\text{C}$	55	A	
I_{TSM}	Surge On-State Current	$\frac{1}{2}$ cycle, 50Hz/60Hz, peak value, non-repetitive	450/500	A	
I^2t	I^2t	Value for one cycle of surge current	1000	A^2S	
P_{GM}	Peak Gate Power Dissipation		10	W	
$P_{G(AV)}$	Average Gate Power Dissipation		1	W	
I_{FGM}	Peak Gate Current		3	A	
V_{FGM}	Peak Gate Voltage (Forward)		10	V	
V_{RGM}	Peak Gate Voltage (Reverse)		5	V	
di/dt	Critical Rate of Rise of On-State Current	$I_G=100\text{mA}$, $T_j=25^\circ\text{C}$, $V_D=\frac{1}{2}V_{DRM}$, $dI_G/dt=0.1\text{A}/\mu\text{s}$	100	$\text{A}/\mu\text{s}$	
V_{ISO}	Isolation Breakdown Voltage (R.M.S.)	A.C. 1 minute	2500	V	
T_j	Operating Junction Temperature		-40 to +125	$^\circ\text{C}$	
T_{stg}	Storage Temperature		-40 to +125	$^\circ\text{C}$	
	Mounting Torque	Mounting (M6)	Recommended Value 2.5-3.9 (25-40)	4.7 (48)	$\text{N}\cdot\text{m}$ ($\text{kgf}\cdot\text{cm}$)
		Terminal (M5)	Recommended Value 1.5-2.5 (15-25)	2.7 (28)	
	Mass	Typical Value	170	g	

Electrical Characteristics

Symbol	Item	Conditions	Ratings	Unit
I_{DRM}	Repetitive Peak Off-State Current, max.	at V_{DRM} , Single phase, half wave, $T_j=125^\circ\text{C}$	8	mA
V_{TM}	Peak On-State Voltage, max.	On-State Current 75A, $T_j=125^\circ\text{C}$ Inst. measurement	1.60	V
I_{GT}/V_{GT}	Gate Trigger Current/Voltage, max.	$T_j=25^\circ\text{C}$, $I_T=1\text{A}$, $V_D=6\text{V}$	50/2	mA/V
V_{GD}	Non-Trigger Gate, Voltage, min.	$T_j=125^\circ\text{C}$, $V_D=\frac{1}{2}V_{DRM}$	0.25	V
t_{gt}	Turn On Time, max.	$I_T=25\text{A}$, $I_G=100\text{mA}$, $T_j=25^\circ\text{C}$, $V_D=\frac{1}{2}V_{DRM}$, $dI_G/dt=0.1\text{A}/\mu\text{s}$	10	μs
dv/dt	Critical Rate of Rise of Off-State Voltage, min.	$T_j=125^\circ\text{C}$, $V_D=\frac{2}{3}V_{DRM}$, Exponential wave.	500	$\text{V}/\mu\text{s}$
I_H	Holding Current, typ.	$T_j=25^\circ\text{C}$	50	mA
I_L	Latching Current, typ.	$T_j=25^\circ\text{C}$	100	mA
$R_{th(j-c)}$	Thermal Impedance, max.	Junction to case, per $\frac{1}{2}$ Module	0.80	$^\circ\text{C}/\text{W}$
		Junction to case, per 1 Module	0.40	

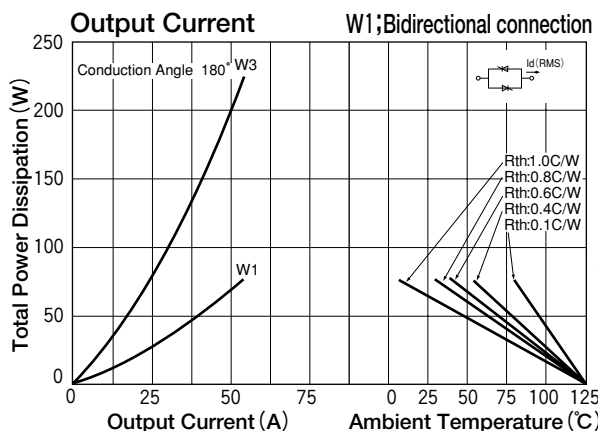
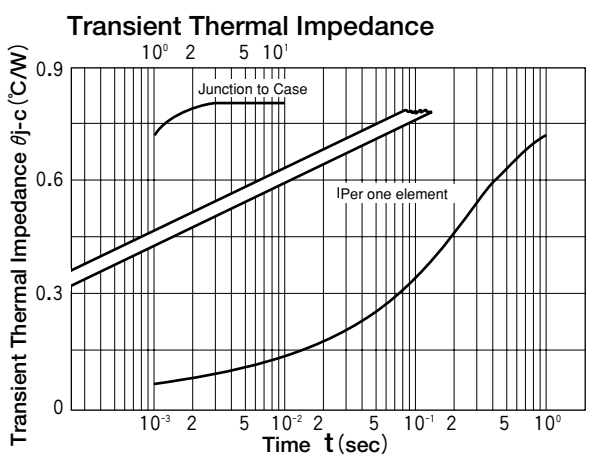
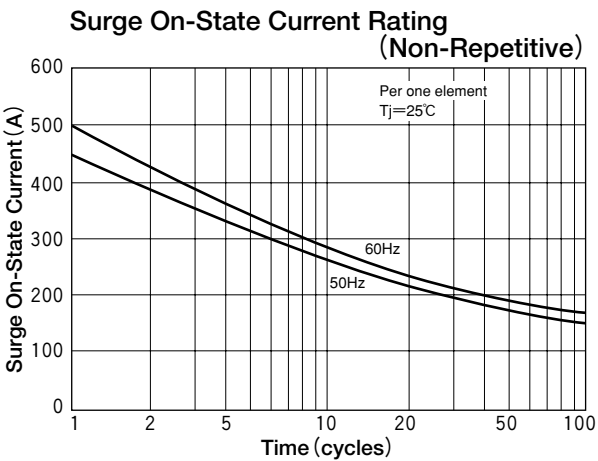
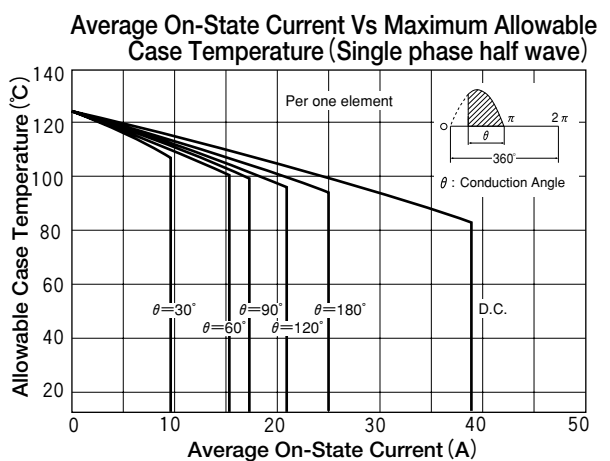
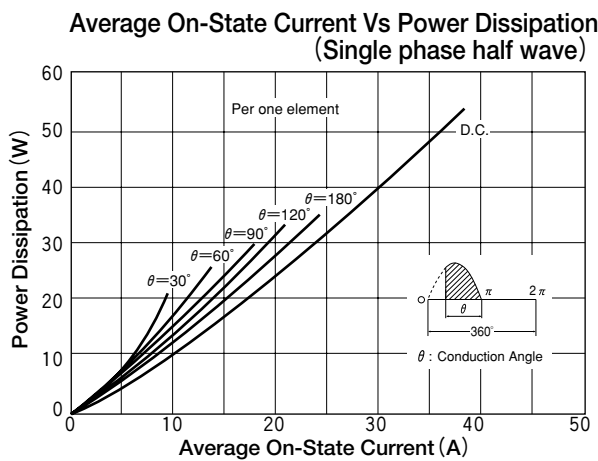
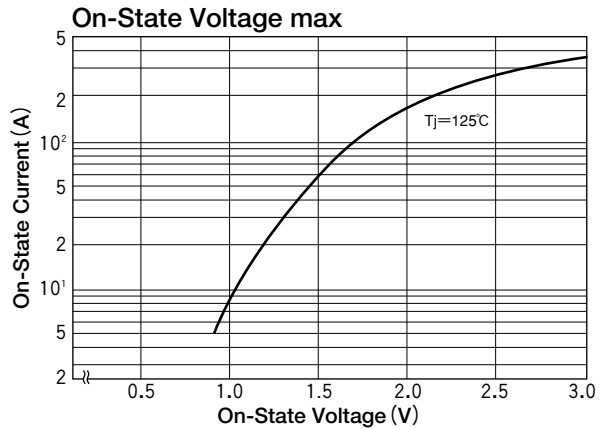
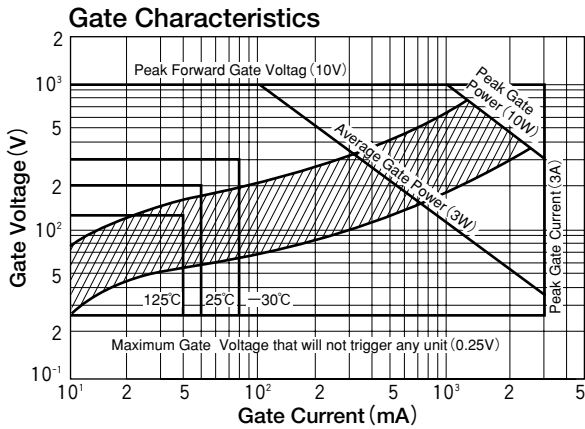

W3; Three phase bidirectional connection

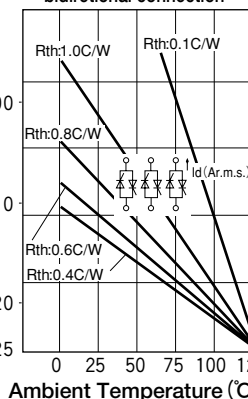

RMS On-State Current Vs Allowable Case Temperature

