

BCR12PM

MEDIUM POWER USE
INSULATED TYPE, PLANAR PASSIVATION TYPE

BCR12PM

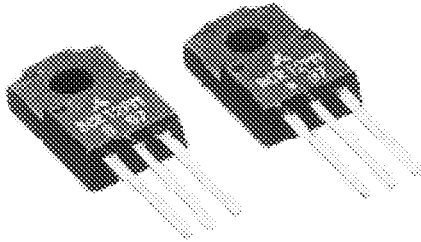

- **IT (RMS)** **12A**
- **VDRM** **400V/600V**
- **IFGT I, IRGT I, IRGT II** **30mA (20mA) *5**
- **Viso** **1500V**
- **UL Recognized: File No. E80276**

OUTLINE DRAWING

Dimensions
in mm

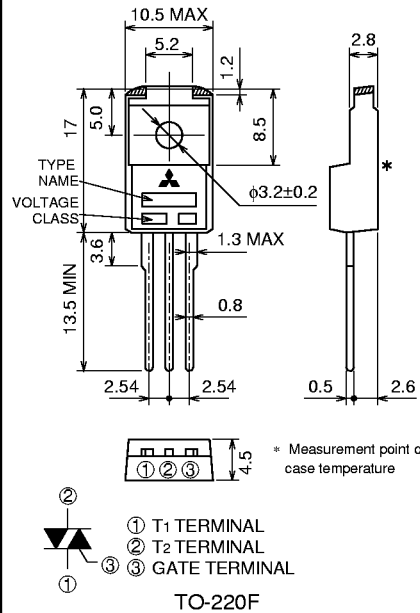

APPLICATION

Switching mode power supply, light dimmer, electric flasher unit, hair driver, control of household equipment such as TV sets · stereo · refrigerator · washing machine · infrared kotatsu · carpet, solenoid drivers, small motor control, copying machine, electric tool

MAXIMUM RATINGS

Symbol	Parameter	Voltage class		Unit
		8	12	
VDRM	Repetitive peak off-state voltage *1	400	600	V
VDSM	Non-repetitive peak off-state voltage *1	500	720	V

Symbol	Parameter	Conditions	Ratings	Unit
IT (RMS)	RMS on-state current	Commercial frequency, sine full wave 360° conduction, Tc=74°C	12	A
ITSM	Surge on-state current	60Hz sinewave 1 full cycle, peak value, non-repetitive	120	A
I _{F1}	I _{F1} for fusing	Value corresponding to 1 cycle of half wave 60Hz, surge on-state current	60	A ² s
P _{GM}	Peak gate power dissipation		5	W
P _{G (AV)}	Average gate power dissipation		0.5	W
V _{GM}	Peak gate voltage		10	V
I _{GM}	Peak gate current		2	A
T _J	Junction temperature		-40 ~ +125	°C
T _{stg}	Storage temperature		-40 ~ +125	°C
—	Weight	Typical value	2.0	g
Viso	Isolation voltage	Ta=25°C, AC 1 minute, T1 · T2 · G terminal to case	1500	V

*1. Gate open.

BCR12PM

MEDIUM POWER USE
INSULATED TYPE, PLANAR PASSIVATION TYPE

ELECTRICAL CHARACTERISTICS

Symbol	Parameter	Test conditions	Limits			Unit
			Min.	Typ.	Max.	
IDRM	Repetitive peak off-state current	T _j =125°C, V _{DRM} applied	—	—	2.0	mA
V _{TM}	On-state voltage	T _c =25°C, I _{TM} =20A, Instantaneous measurement	—	—	1.6	V
V _{FGT I}	Gate trigger voltage *2	T _j =25°C, V _D =6V, R _L =6Ω, R _G =330Ω	I	—	1.5	V
V _{RGT I}			II	—	1.5	V
V _{RGT III}			III	—	1.5	V
I _{FGT I}	Gate trigger current *2	T _j =25°C, V _D =6V, R _L =6Ω, R _G =330Ω	I	—	30*5	mA
I _{RGT I}			II	—	30*5	mA
I _{RGT III}			III	—	30*5	mA
V _{GD}	Gate non-trigger voltage	T _j =125°C, V _D =1/2V _{DRM}	0.2	—	—	V
R _{th(j-c)}	Thermal resistance	Junction to case *4	—	—	3.5	°C/W
(dv/dt) _c	Critical-rate of rise of off-state commutating voltage		*3	—	—	V/μs

*2. Measurement using the gate trigger characteristics measurement circuit.
 *3. The critical-rate of rise of the off-state commutating voltage is shown in the table below.
 *4. The contact thermal resistance R_{th(c-t)} in case of greasing is 0.5°C/W.
 *5. High sensitivity (I_{GT}≤20mA) is also available. (IGT item ①)

Voltage class	V _{DRM} (V)	(dv/dt) _c			Test conditions	Commutating voltage and current waveforms (inductive load)
		Symbol	Min.	Unit		
8	400	R	—	V/μs	1. Junction temperature T _j =125°C 2. Rate of decay of on-state commutating current (di/dt) _c =6.0A/ms 3. Peak off-state voltage V _D =400V	
		L	10			
12	600	R	—			
		L	10			

PERFORMANCE CURVES

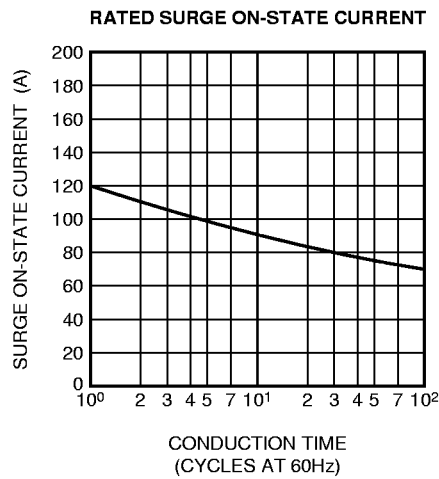
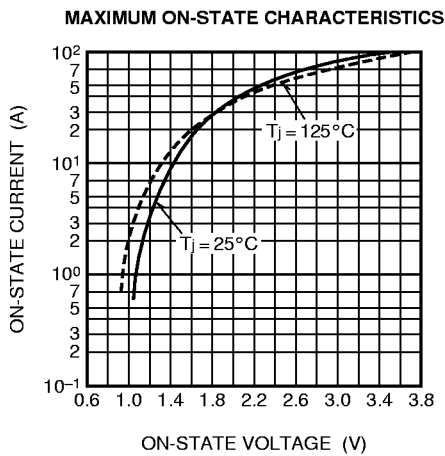

BCR12PM

MEDIUM POWER USE
INSULATED TYPE, PLANAR PASSIVATION TYPE

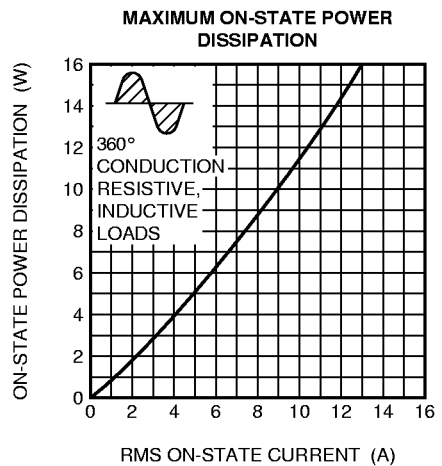
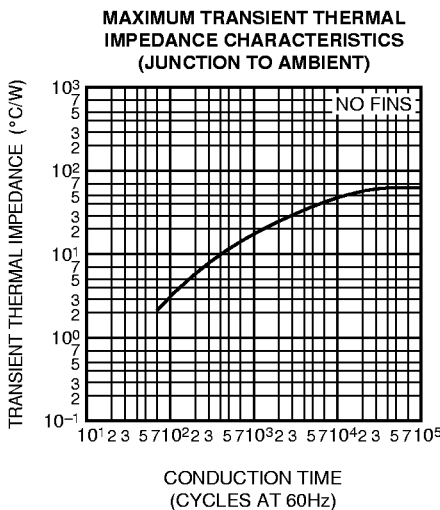
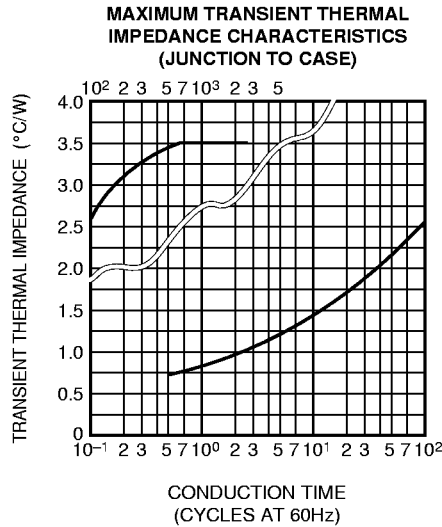
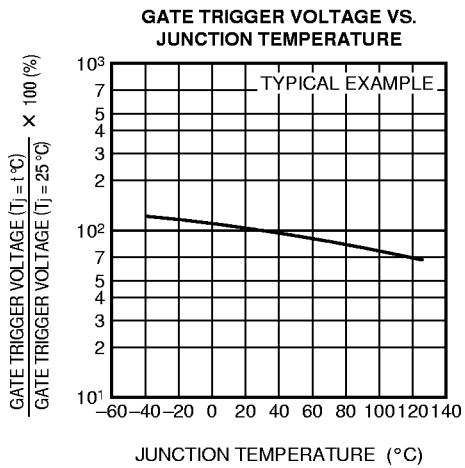
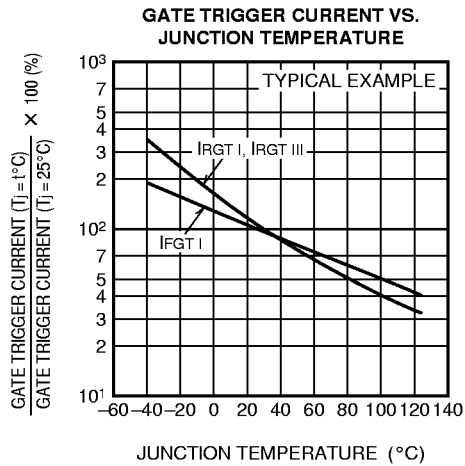
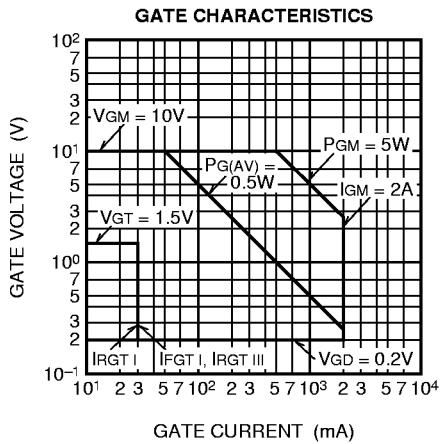

BCR12PM

MEDIUM POWER USE
INSULATED TYPE, PLANAR PASSIVATION TYPE

ALLOWABLE CASE TEMPERATURE
VS. RMS ON-STATE CURRENT

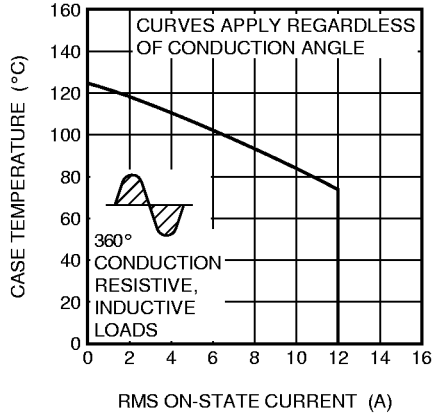

ALLOWABLE AMBIENT TEMPERATURE
VS. RMS ON-STATE CURRENT

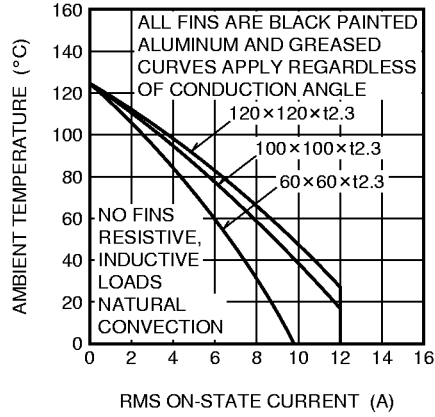

ALLOWABLE AMBIENT TEMPERATURE
VS. RMS ON-STATE CURRENT

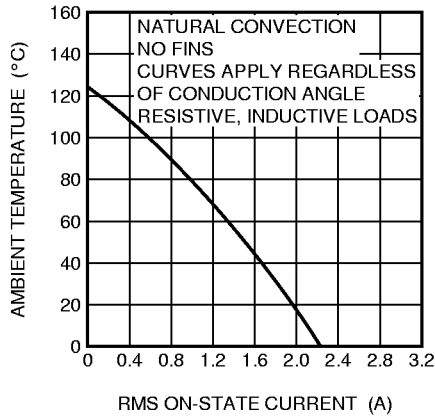

REPETITIVE PEAK OFF-STATE
CURRENT VS. JUNCTION
TEMPERATURE

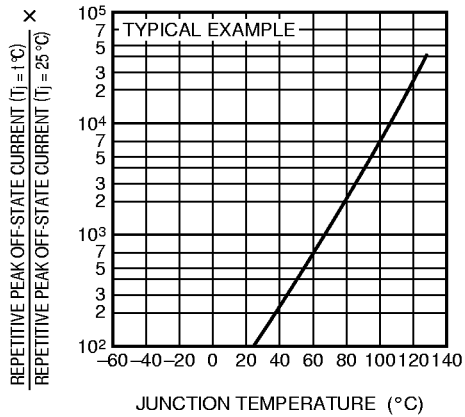

HOLDING CURRENT VS.
JUNCTION TEMPERATURE

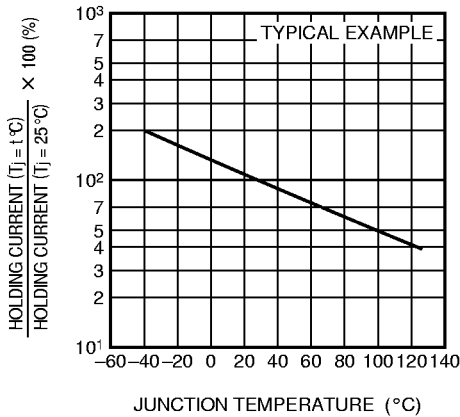

LACHING CURRENT VS.
JUNCTION TEMPERATURE

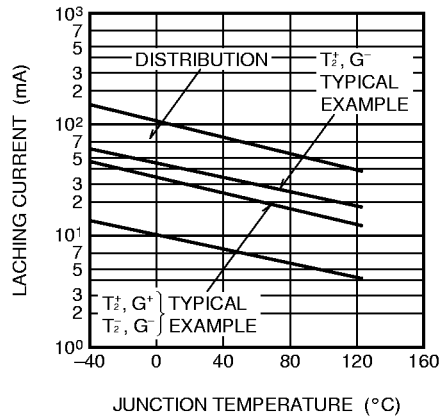

BCR12PM

MEDIUM POWER USE
INSULATED TYPE, PLANAR PASSIVATION TYPE

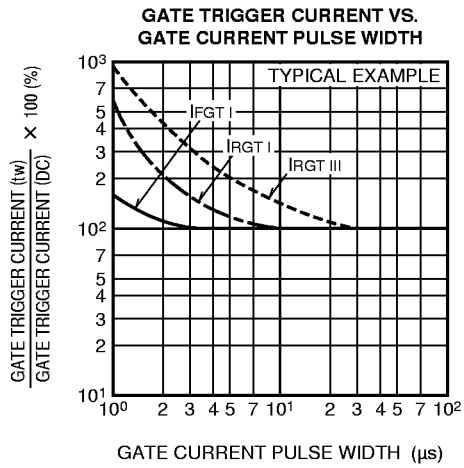
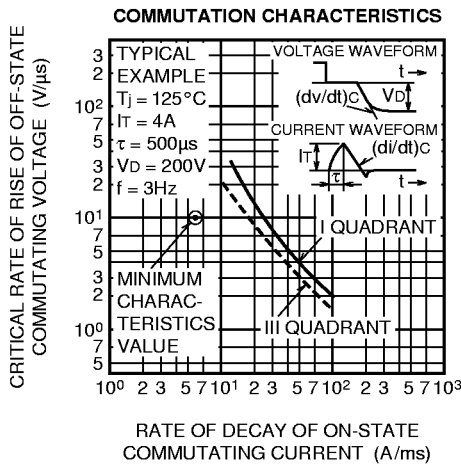
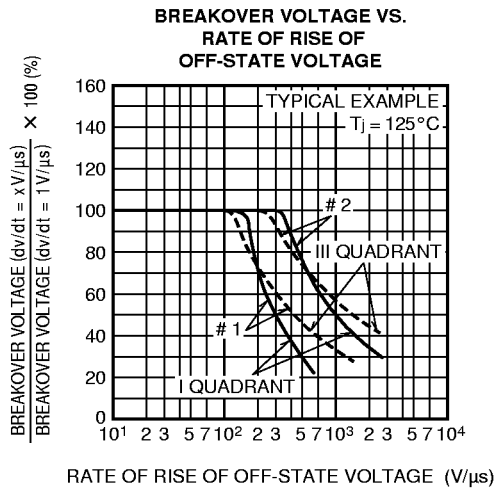
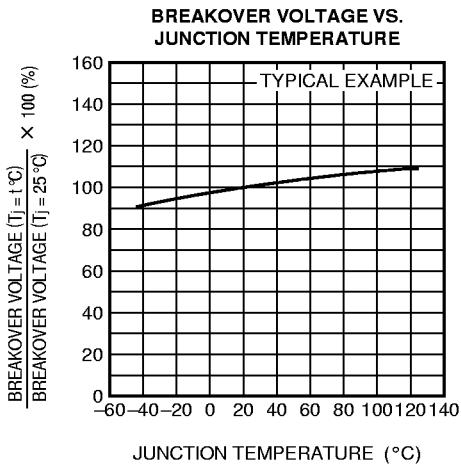

GATE TRIGGER CHARACTERISTICS TEST CIRCUITS

