

### Single IGBTMOD™ HVIGBT 600 Amperes/4500 Volts

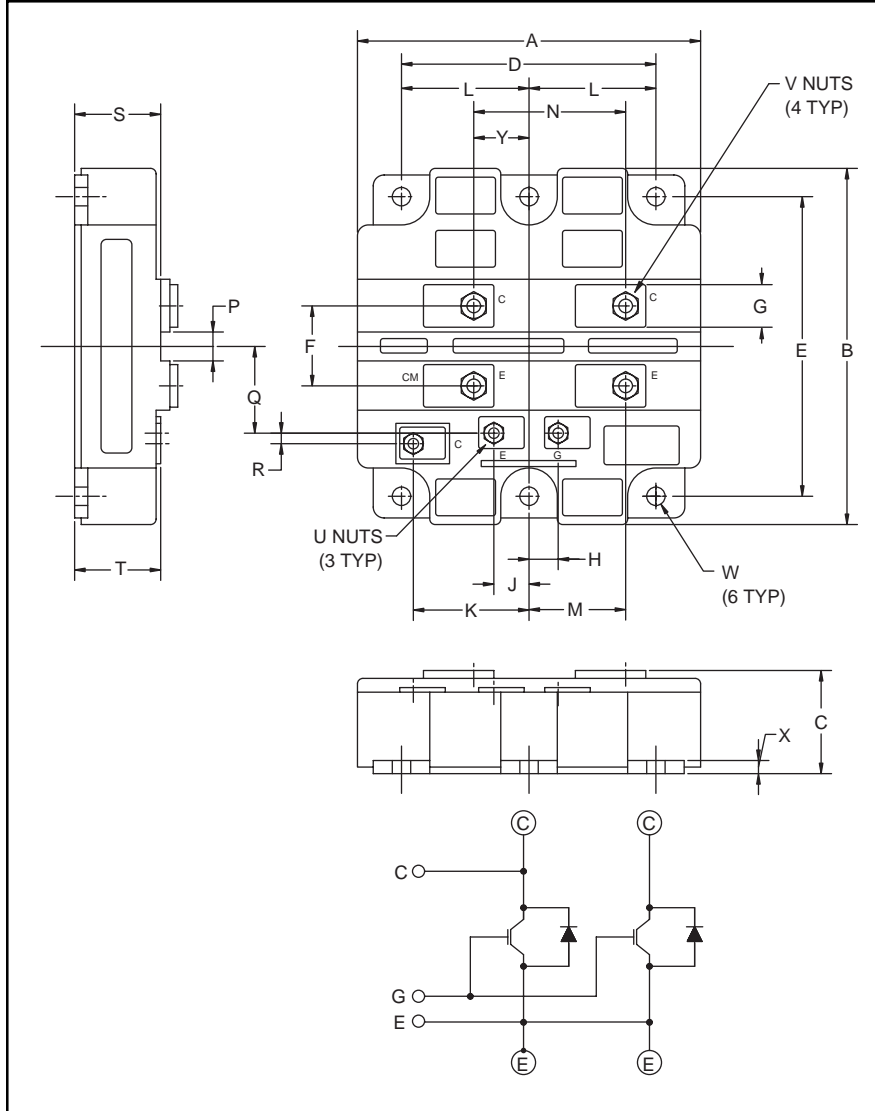

Outline Drawing and Circuit Diagram

Dimensions	Inches	Millimeters
A	5.12	130.0
B	5.51	140.0
C	1.50	38.0
D	4.48	114.0
E	4.88±0.01	124.0±0.25
F	1.57	40.0
G	0.79	20.0
H	0.41	10.35
J	0.42	10.65
K	1.92	48.8
L	2.24±0.01	57.0±0.25
M	1.71	43.5

Dimensions	Inches	Millimeters
N	2.42	61.5
P	0.59	15.0
Q	1.57	40.0
R	0.20	5.2
S	1.16	29.5
T	1.10	28.0
U	M4 Metric	M4
V	M8 Metric	M8
W	0.28 Dia.	Dia. 7.0
X	0.20	5.0
Y	0.71	18.0



#### Description:

Powerex IGBTMOD™ Modules are designed for use in switching applications. Each module consists of one IGBT Transistor with a reverse-connected super-fast recovery free-wheel diode. All components and interconnects are isolated from the heat sinking baseplate, offering simplified system assembly and thermal management.

#### Features:

- Low Drive Power
- Low  $V_{CE(sat)}$
- Super-Fast Recovery Free-Wheel Diode
- Isolated Baseplate for Easy Heat Sinking

#### Applications:

- Traction
- Medium Voltage Drives
- High Voltage Power Supplies

#### Ordering Information:

Example: Select the complete part module number you desire from the table below -i.e. CM600HB-90H is a 4500V ( $V_{CES}$ ), 600 Ampere Single IGBTMOD™ Power Module.

Type	Current Rating Amperes	$V_{CES}$ Volts (x 50)
CM	600	90



Powerex, Inc., 200 Hillis Street, Youngwood, Pennsylvania 15697-1800 (724) 925-7272

**CM600HB-90H**  
**Single IGBTMOD™ HVIGBT**  
 600 Amperes/4500 Volts

**Absolute Maximum Ratings,  $T_j = 25\text{ }^\circ\text{C}$  unless otherwise specified**

Ratings	Symbol	CM600HB-90H	Units
Junction Temperature	$T_j$	-40 to 150	$^\circ\text{C}$
Storage Temperature	$T_{stg}$	-40 to 125	$^\circ\text{C}$
Collector-Emitter Voltage ( $V_{GE} = 0V$ )	$V_{CES}$	4500	Volts
Gate-Emitter Voltage ( $V_{CE} = 0V$ )	$V_{GES}$	$\pm 20$	Volts
Collector Current ( $T_c = 25^\circ\text{C}$ )	$I_C$	600	Amperes
Peak Collector Current (Pulse)	$I_{CM}$	1200*	Amperes
Diode Forward Current** ( $T_c = 25^\circ\text{C}$ )	$I_E$	600	Amperes
Diode Forward Surge Current** (Pulse)	$I_{EM}$	1200*	Amperes
Maximum Collector Dissipation ( $T_c = 25^\circ\text{C}$ , IGBT Part, $T_j \leq 125^\circ\text{C}$ )	$P_C$	6700	Watts
Max. Mounting Torque M8 Terminal Screws	–	115	in-lb
Max. Mounting Torque M6 Mounting Screws	–	53	in-lb
Max. Mounting Torque M4 Auxiliary Terminal Screws	–	17	in-lb
Module Weight (Typical)	–	1.5	kg
Isolation Voltage (Charged Part to Baseplate, AC 60Hz 1 min.)	$V_{iso}$	6000	Volts

\* Pulse width and repetition rate should be such that device junction temperature ( $T_j$ ) does not exceed  $T_{j(max)}$  rating.  
 \*\*Represents characteristics of the anti-parallel, emitter-to-collector free-wheel diode (FWDi).

**Static Electrical Characteristics,  $T_j = 25\text{ }^\circ\text{C}$  unless otherwise specified**

Characteristics	Symbol	Test Conditions	Min.	Typ.	Max.	Units
Collector-Cutoff Current	$I_{CES}$	$V_{CE} = V_{CES}, V_{GE} = 0V$	–	–	12.0	mA
Gate Leakage Current	$I_{GES}$	$V_{GE} = V_{GES}, V_{CE} = 0V$	–	–	0.5	$\mu\text{A}$
Gate-Emitter Threshold Voltage	$V_{GE(th)}$	$I_C = 60\text{mA}, V_{CE} = 10V$	4.5	6.0	7.5	Volts
Collector-Emitter Saturation Voltage	$V_{CE(sat)}$	$I_C = 600\text{A}, V_{GE} = 15V, T_j = 25^\circ\text{C}$	–	3.0	3.9*	Volts
		$I_C = 600\text{A}, V_{GE} = 15V, T_j = 125^\circ\text{C}$	–	3.3	–	Volts
Total Gate Charge	$Q_G$	$V_{CC} = 2250V, I_C = 600\text{A}, V_{GE} = 15V$	–	5.4	–	$\mu\text{C}$
Emitter-Collector Voltage**	$V_{EC}$	$I_E = 600\text{A}, V_{GE} = 0V$	–	4.0	5.2	Volts

\* Pulse width and repetition rate should be such that device junction temperature rise is negligible.  
 \*\*Represents characteristics of the anti-parallel, emitter-to-collector free-wheel diode (FWDi).



Powerex, Inc., 200 Hillis Street, Youngwood, Pennsylvania 15697-1800 (724) 925-7272

**CM600HB-90H**  
**Single IGBTMOD™ HVIGBT**  
 600 Amperes/4500 Volts

**Dynamic Electrical Characteristics,  $T_j = 25\text{ }^\circ\text{C}$  unless otherwise specified**

Characteristics	Symbol	Test Conditions	Min.	Typ.	Max.	Units
Input Capacitance	$C_{ies}$		–	108	–	nF
Output Capacitance	$C_{oes}$	$V_{GE} = 0V, V_{CE} = 10V$	–	8.0	–	nF
Reverse Transfer Capacitance	$C_{res}$		–	2.4	–	nF
Resistive	Turn-on Delay Time	$V_{CC} = 2250V, I_C = 600A,$ $V_{GE1} = V_{GE2} = 15V,$ $R_G = 15\Omega$	–	–	2.4	$\mu s$
Load	Rise Time		$t_{d(on)}$			
Switching	Turn-off Delay Time		–	–	6.0	$\mu s$
Times	Fall Time	Resistive Load Switching Operation	–	–	1.2	$\mu s$
Diode Reverse Recovery Time**		$I_E = 600A, di_E/dt = -1200A/\mu s$	–	–	1.8	$\mu s$
Diode Reverse Recovery Charge**		$I_E = 600A, di_E/dt = -1200A/\mu s$	–	240*	–	$\mu C$

\* Pulse width and repetition rate should be such that device junction temperature rise is negligible.

\*\*Represents characteristics of the anti-parallel, emitter-to-collector free-wheel diode (FWDi).

**Thermal and Mechanical Characteristics,  $T_j = 25\text{ }^\circ\text{C}$  unless otherwise specified**

Characteristics	Symbol	Test Conditions	Min.	Typ.	Max.	Units
Thermal Resistance, Junction to Case	$R_{th(j-c)}$ Q	Per IGBT	–	–	0.015	K/W
Thermal Resistance, Junction to Case	$R_{th(j-c)}$ D	Per FWDi	–	–	0.030	K/W
Contact Thermal Resistance, Case to Fin	$R_{th(c-f)}$	Per Module, Thermal Grease Applied	–	0.010	–	K/W



Powerex, Inc., 200 Hillis Street, Youngwood, Pennsylvania 15697-1800 (724) 925-7272

**CM600HB-90H**  
**Single IGBTMOD™ HVIGBT**  
 600 Amperes/4500 Volts

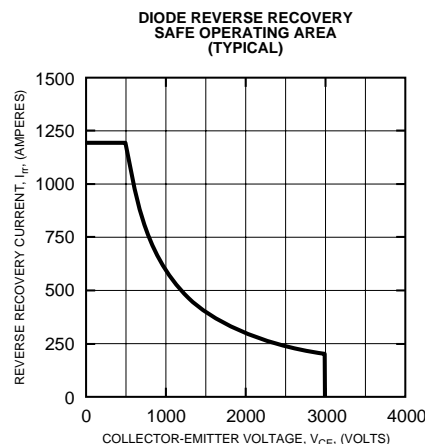
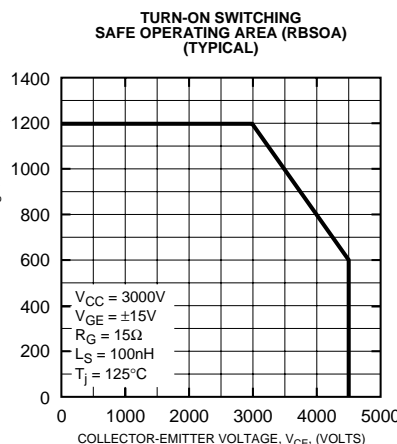
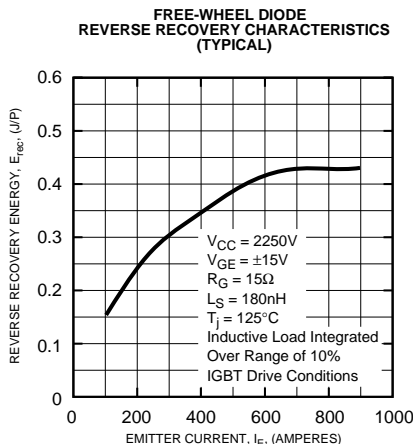
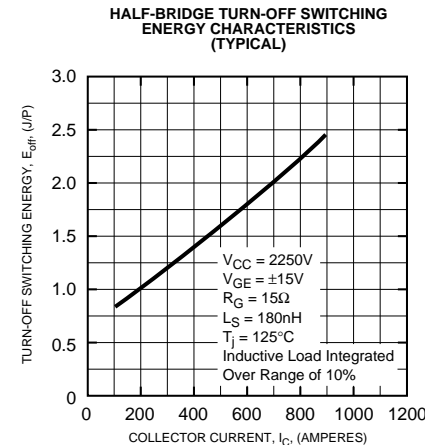
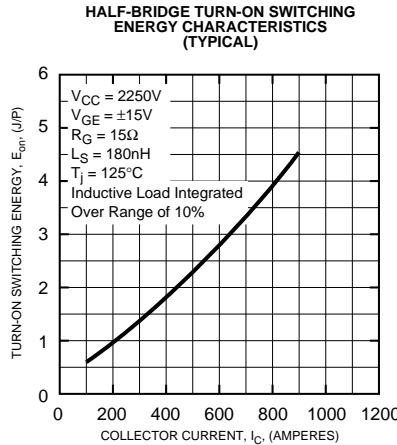
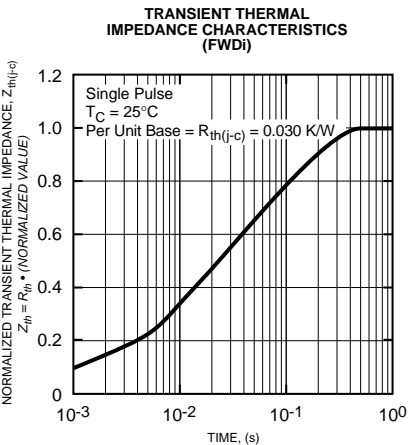
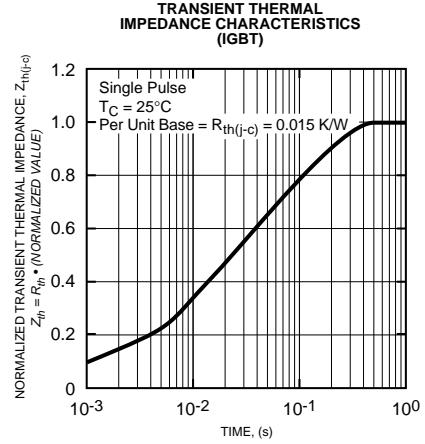
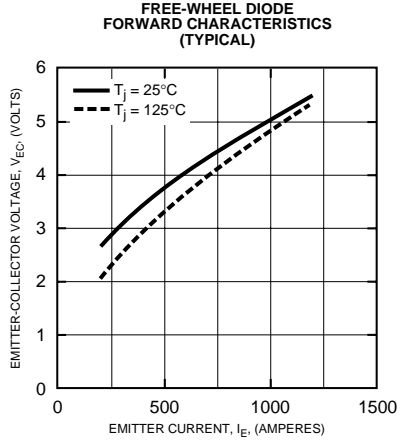
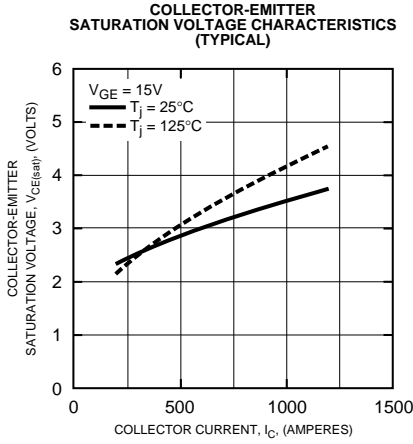



LittleDiode supplies new, hard to find or obsolete electronic components and semiconductors all over the world.

With over two million different components listed you are sure to find the part you need.

Feel free to visit us today at our online store:

[LittleDiode.com](http://LittleDiode.com)

Looking forward to providing you with the best possible service.