

# SHINDENGEN

## Schottky Rectifiers (SBD)

Single

# D1FH3

## 30V 3A

### OUTLINE DIMENSIONS

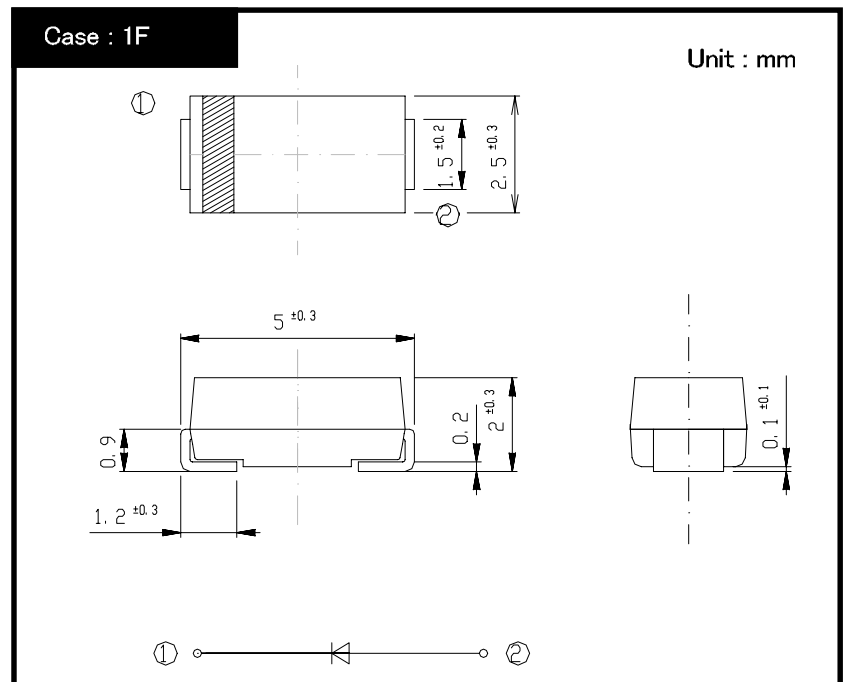

### RATINGS

#### ● Absolute Maximum Ratings (Tc=25°C)

Item	Symbol	Conditions	Ratings	Unit
Storage Temperature	Tstg		-55~125	°C
Operating Junction Temperature	Tj		125	°C
Maximum Reverse Voltage	V <sub>RM</sub>		30	V
Average Rectified Forward Current	I <sub>O</sub>	50Hz sine wave, R-load Tc=95°C	3.0	A
Peak Surge Forward Current	I <sub>FSM</sub>	50Hz sine wave, Non-repetitive 1 cycle peak value, Tj=25°C	60	A

#### ● Electrical Characteristics Tc=25°C

Item	Symbol	Conditions	Ratings	Unit
Forward Voltage	V <sub>F1</sub>	I <sub>F</sub> =1.0A, Pulse measurement	Max.0.30	V
	V <sub>F2</sub>	I <sub>F</sub> =3.0A, Pulse measurement	Max.0.36	
Reverse Current	I <sub>R</sub>	V <sub>R</sub> =V <sub>RM</sub> , Pulse measurement	Max.2.0	mA
Junction Capacitance	C <sub>j</sub>	f=1MHz, V <sub>R</sub> =10V	Typ.130	pF
Thermal Resistance	θ <sub>jc</sub>	junction to case	Max.16	°C/W
	θ <sub>jl</sub>	junction to lead	Max.18	
	θ <sub>ja</sub>	junction to ambient On glass-epoxy substrate	Max.65	

# D1FH3

# Forward Voltage

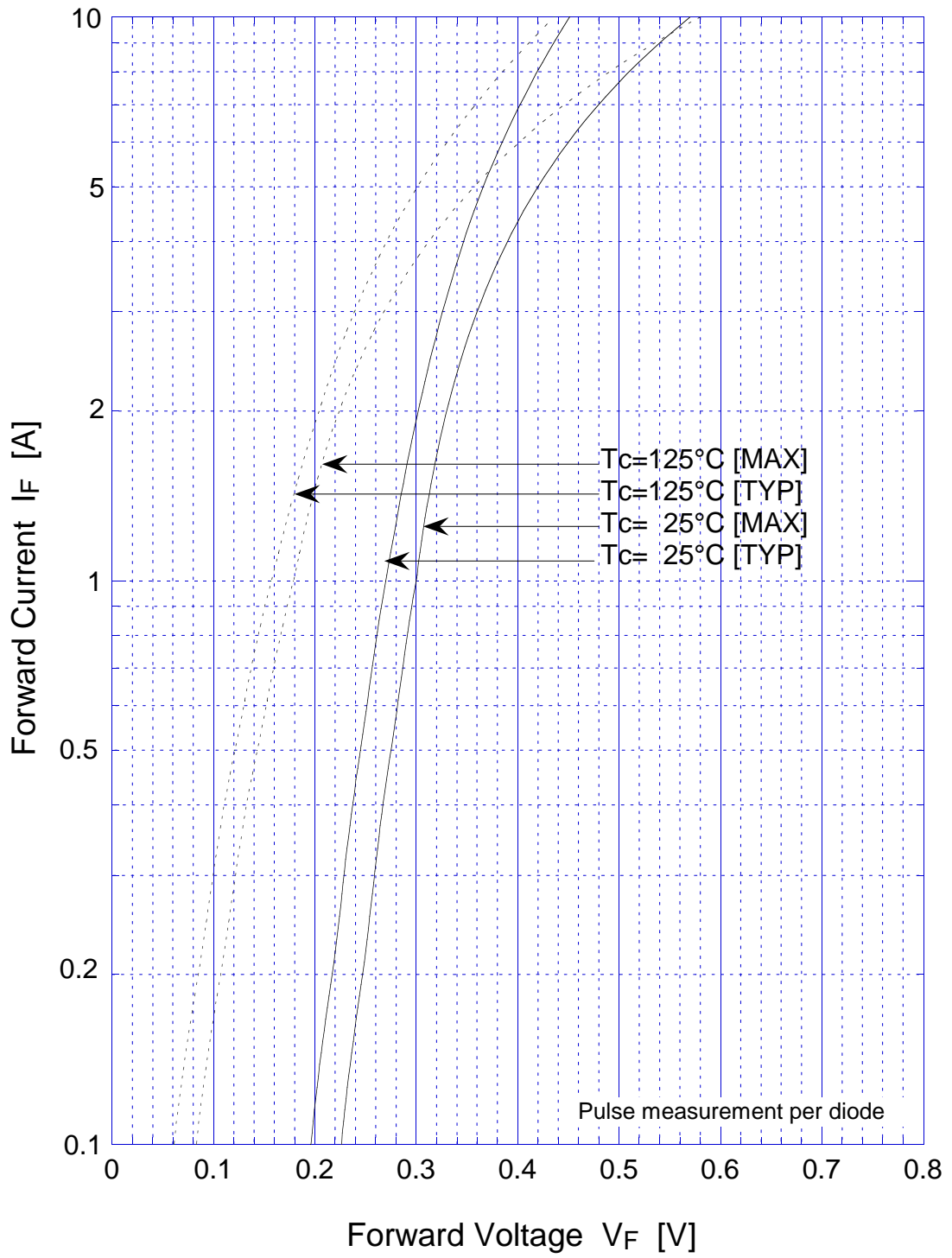

# D1FH3 Forward Power Dissipation

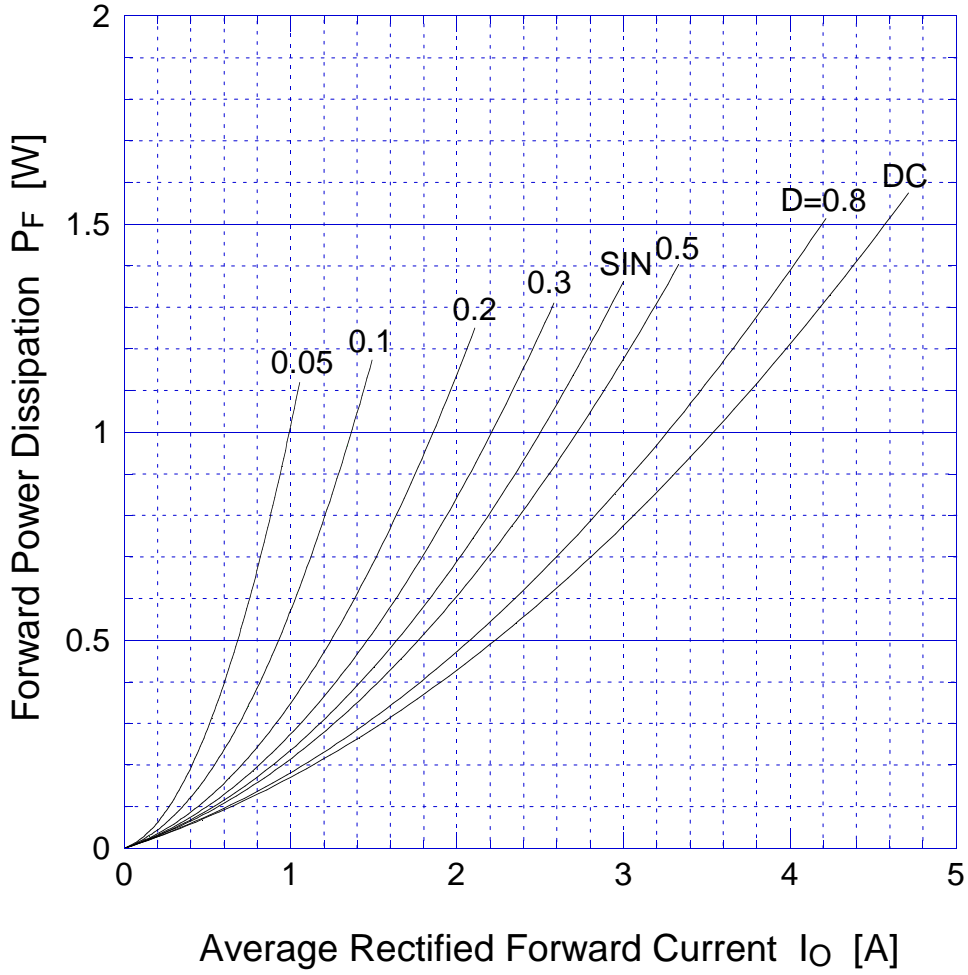

$T_j = 125^\circ\text{C}$

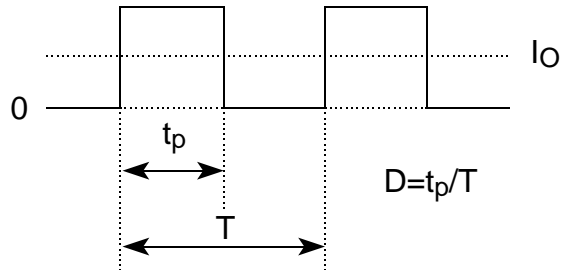

# D1FH3

## Peak Surge Forward Capability

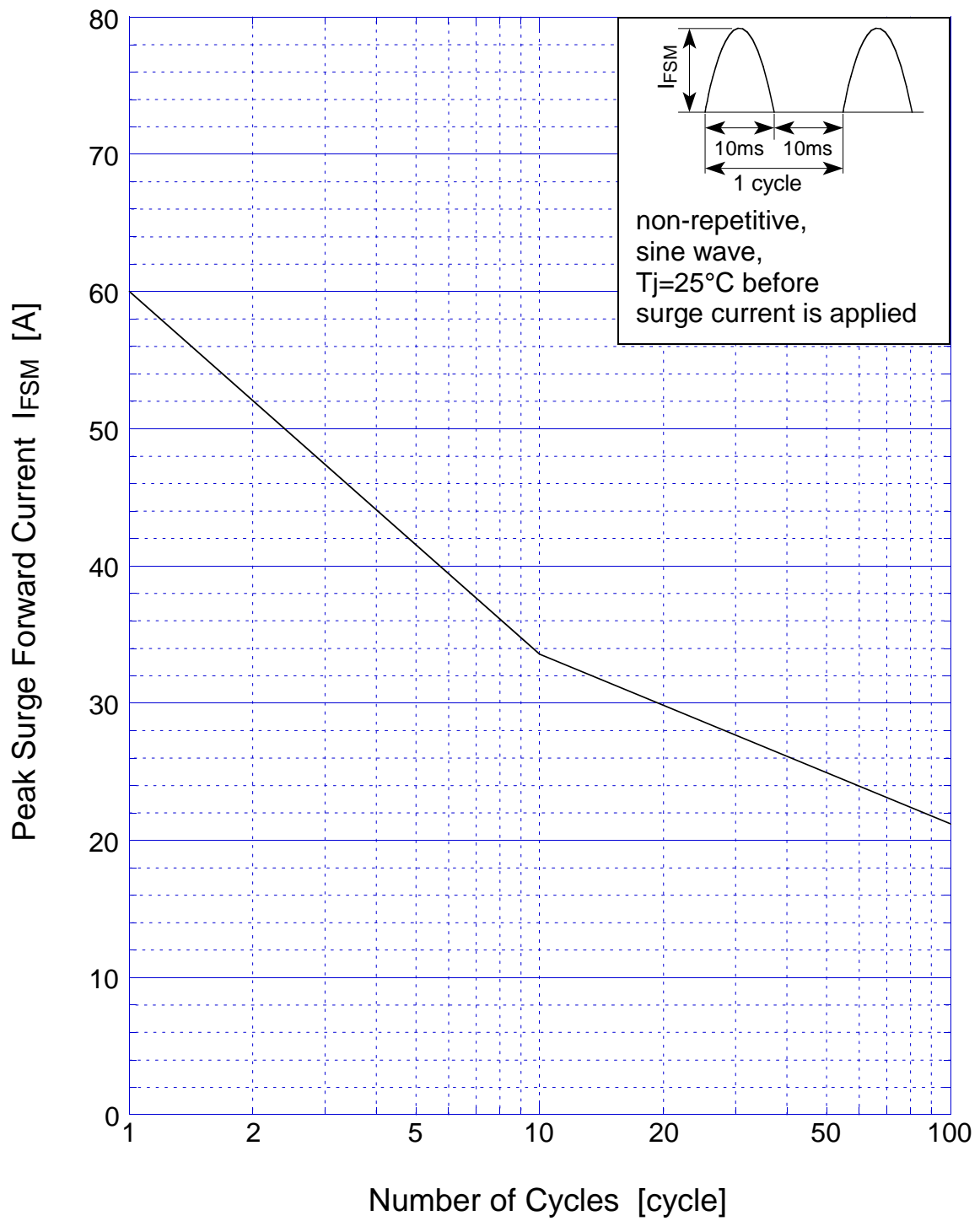

# D1FH3

# Reverse Current

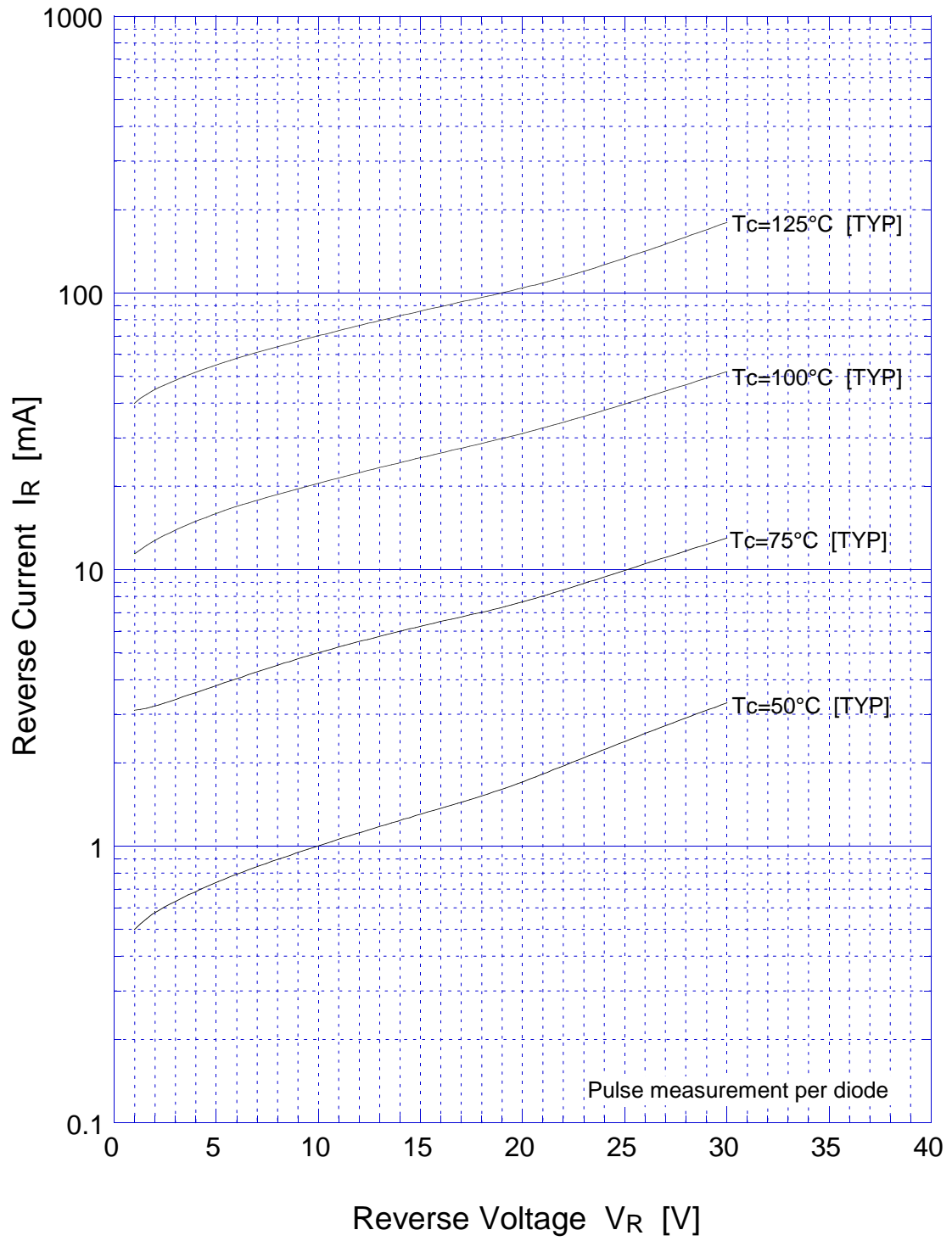

# D1FH3

## Reverse Power Dissipation

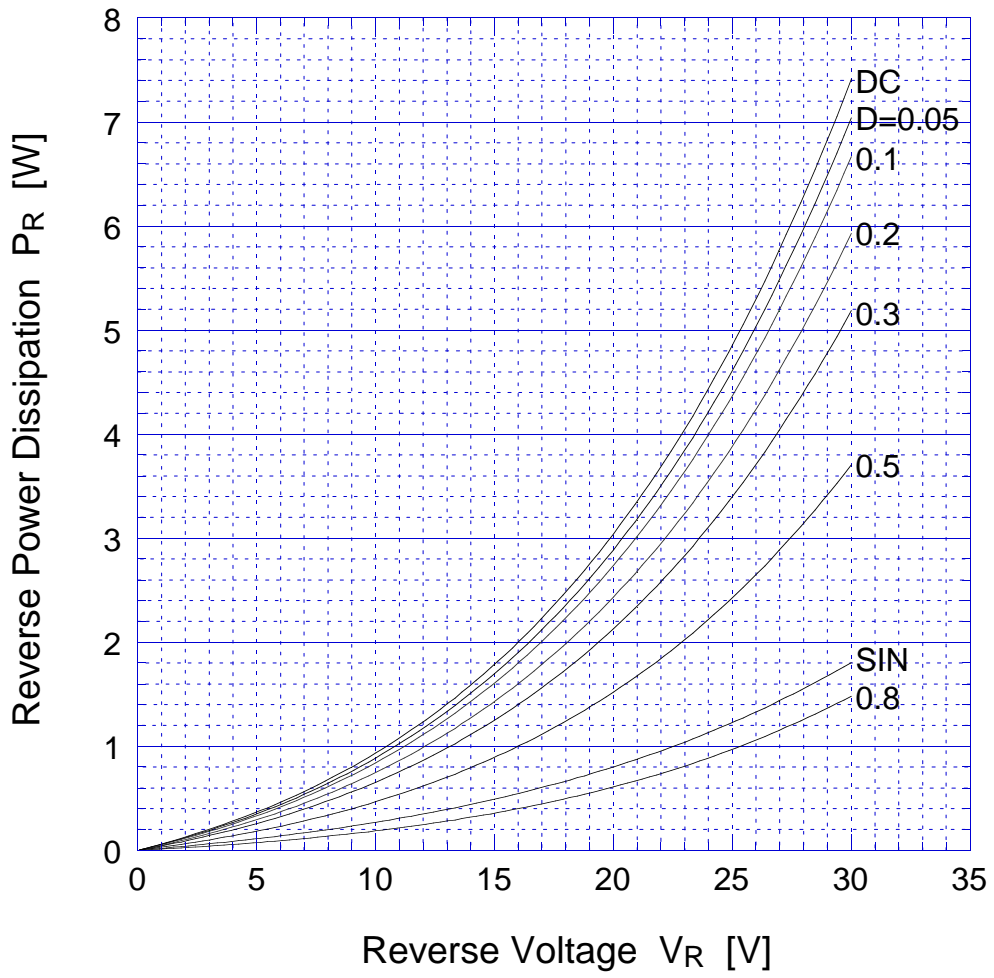

$T_j = 125^\circ\text{C}$

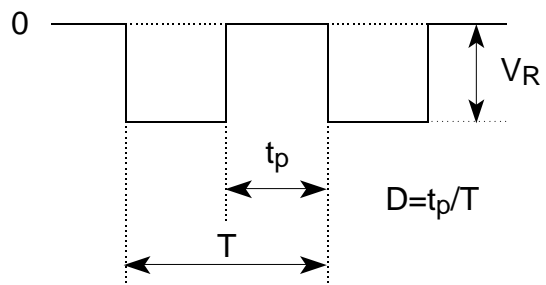

# D1FH3 Junction Capacitance

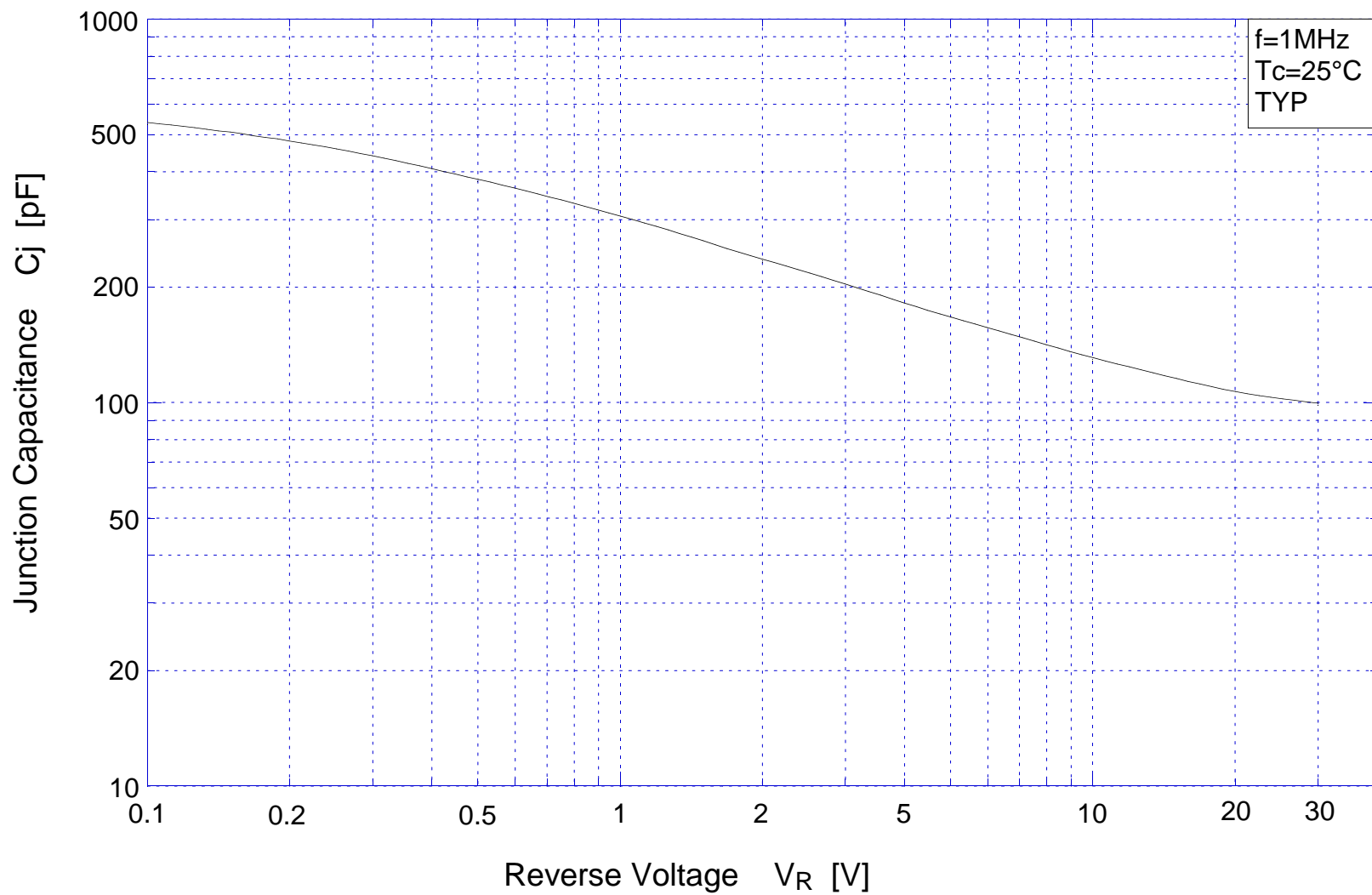

# D1FH3

# Derating Curve

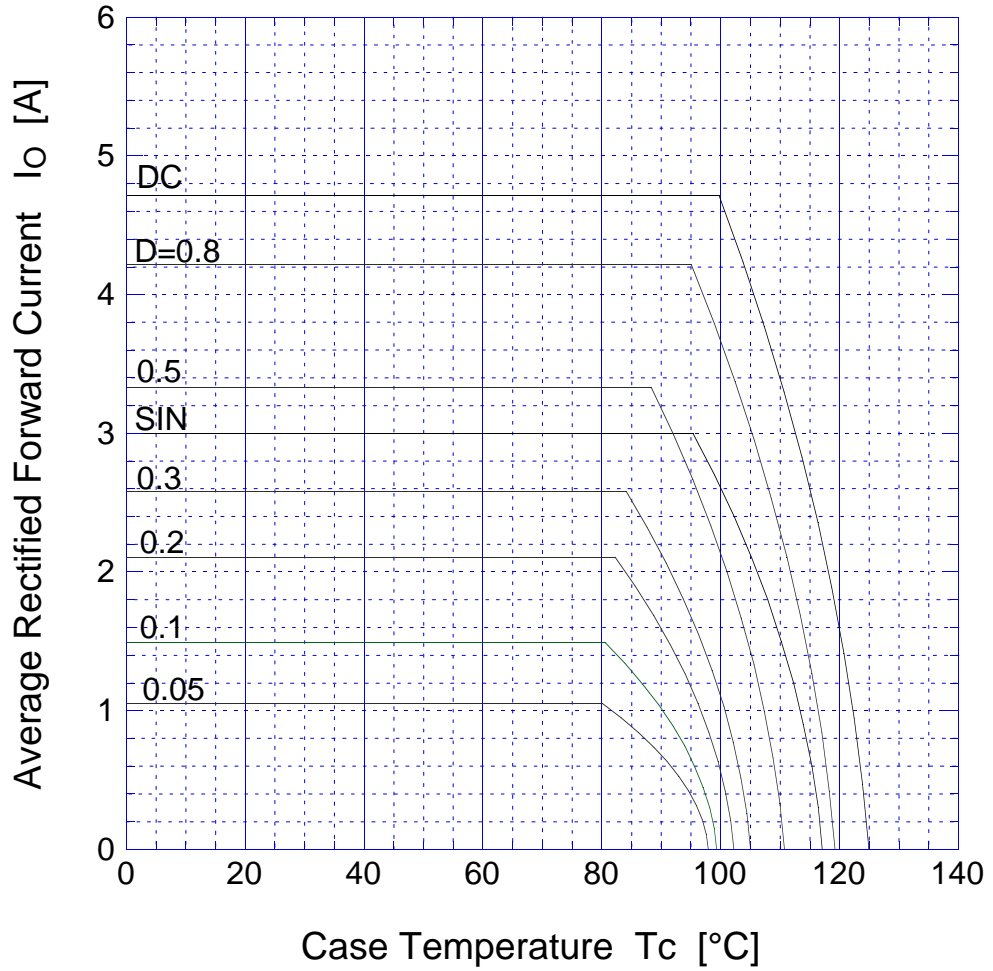

$V_R = 15V$

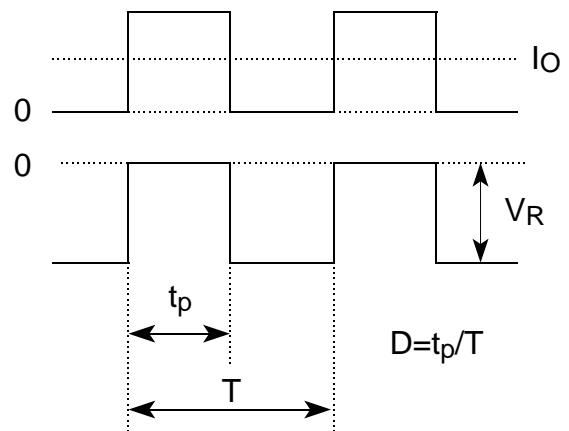

# D1FH3

# Derating Curve

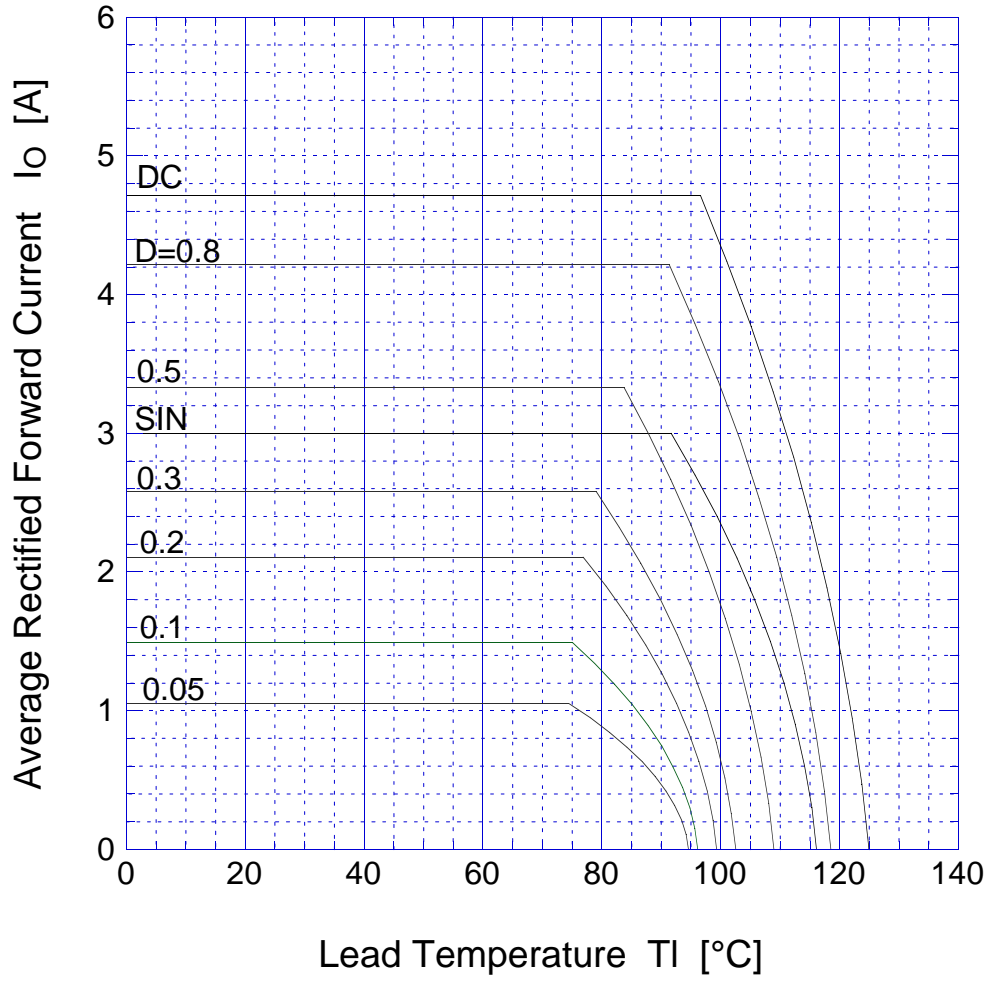

$V_R = 15V$

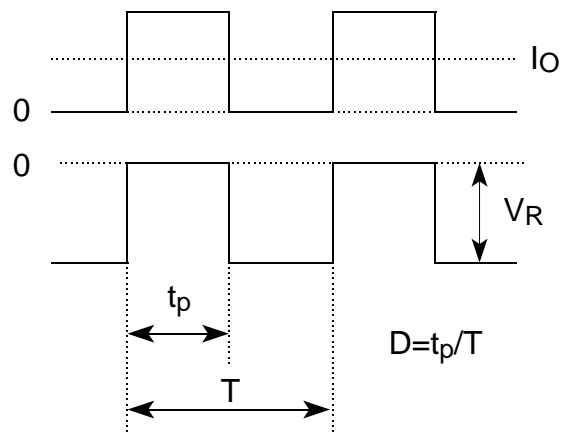

### D1FH3 $\theta_{ja}$ - Conductor pattern area

---

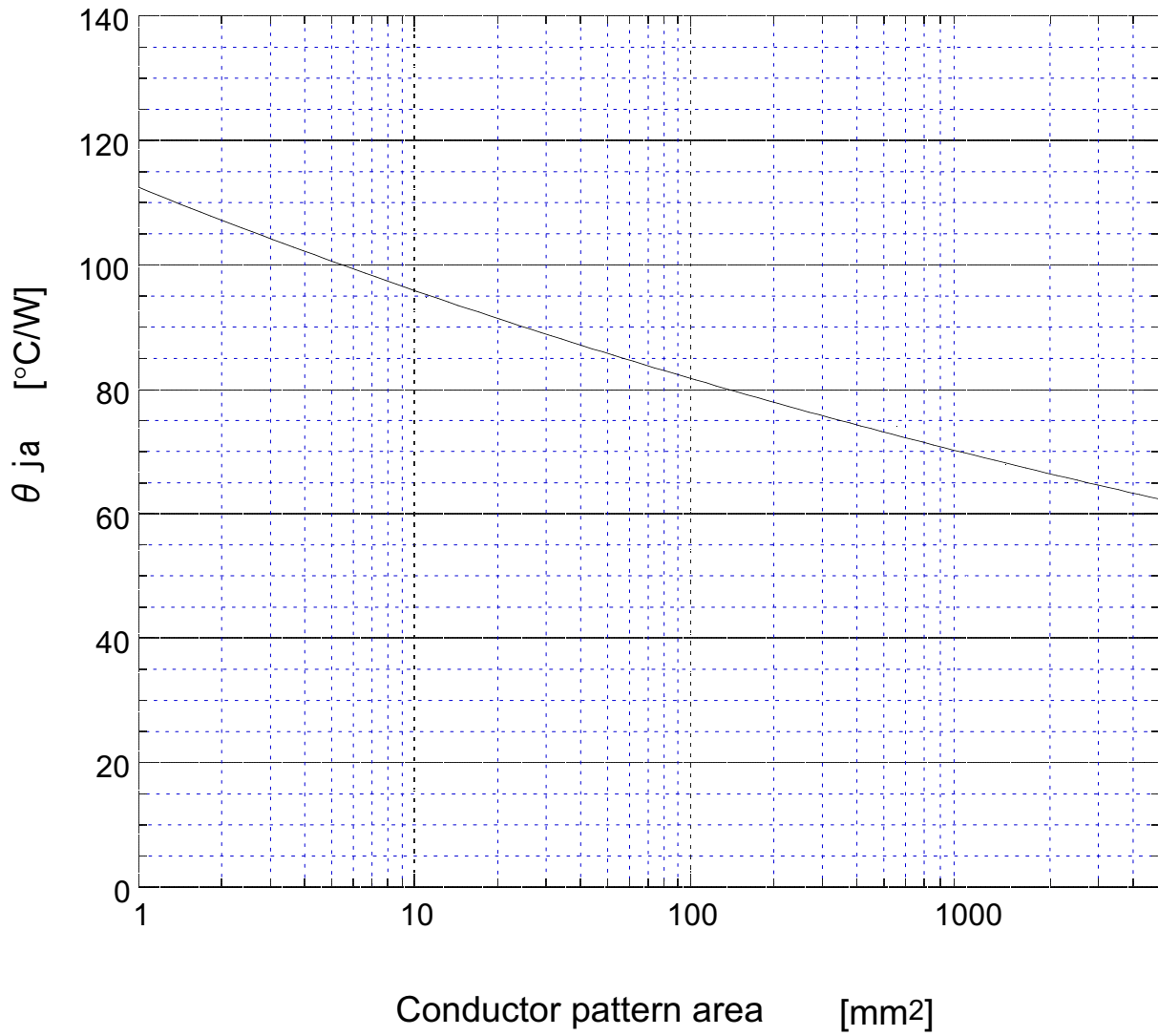

# D1FH3 Transient Thermal Impedance

