



# NPN POWER DARLINGTON TRANSISTOR ARRAY

**D78A3D1**

**100 VOLTS  
3 AMP, 25 WATTS**

Designed for high power switching applications, hammer drive, pulse motor drive and inductive load drive applications.

**Features:**

- High reliability small-sized available (4 in 1)
- Epoxy single-inline package with heat sink (12 pin)
- High collector power dissipation:  $P_D = 25W @ T_A = 25^\circ C$  (Four device action)
- High collector current:  $I_C = 3A$  (Max.)
- High DC current gain:  $hFE = 2000$  (Min.) @  $V_{CE} = 2V, I_C = 1.5A$

ARRAY CONFIGURATION

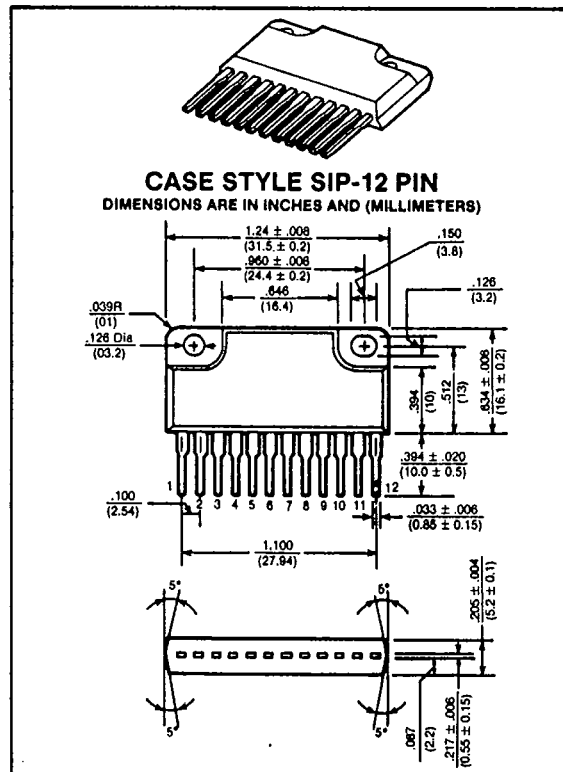
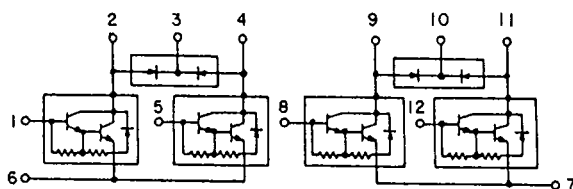

maximum ratings ( $T_A = 25^\circ C$ ) (unless otherwise specified)

RATING	SYMBOL	D78A3D1	UNITS
Collector-Emitter Voltage	$V_{CEO}$	100	Volts
Collector-Base Voltage	$V_{CBO}$	120	Volts
Emitter Base Voltage	$V_{EBO}$	6	Volts
Collector Current — Continuous	$I_C$	3	A
Peak	$I_{CM}$	6	A
Base Current — Continuous	$I_B$	0.5	A
Maximum Forward Current	$I_{FM}$	3	A
Surge Current (1 sec)	$I_{FSM}$	6	A
Reverse Voltage	$V_R$	100	A
Collector Power Dissipation (One Device Action, $T_A = 25^\circ C$ )	$P_D$	3.0	Watts
Collector Power Dissipation (Four Device Action)	$P_D$	5.0 25	Watts
Isolation Voltage (Between Fin to 1 ~ 12 pin)	$V_{isol}$	1000	Volts
Operating and Storage Junction Temperature Range	$T_J, T_{STG}$	-55 to +150	$^\circ C$

thermal characteristics

Thermal Resistance, Junction to Case	$R_{\theta JC}$	5	$^{\circ}C/W$
Thermal Resistance, Junction to Ambient	$R_{\theta JA}$	25	$^{\circ}C/W$
Maximum Lead Temperature for Soldering Purpose: 1/8" from Case for 5 Seconds	$T_L$	260	$^{\circ}C$

electrical characteristics ( $T_A = 25^{\circ}C$ ) (unless otherwise specified)

CHARACTERISTIC	SYMBOL	MIN	TYP	MAX	UNIT
----------------	--------	-----	-----	-----	------

off characteristics

Collector-Emitter Breakdown Voltage ( $I_C = 10mA, I_B = 0$ )	$V_{BR(CEO)}$	100	—	—	Volts
Collector-Base Breakdown Voltage ( $I_C = 1mA, I_E = 0$ )	$V_{BR(CBO)}$	120	—	—	Volts
Collector Cutoff Current ( $V_{CB} = 120V, I_E = 0$ )	$I_{CBO}$	—	—	10	$\mu A$
Collector Cutoff Current ( $V_{CE} = 100V, I_B = 0$ )	$I_{CEO}$	—	—	10	$\mu A$
Emitter Cutoff Current ( $V_{EB} = 6V, I_C = 0$ )	$I_{EBO}$	0.5	—	2.5	mA

second breakdown

Second Breakdown with Base Forward Biased	FBSOA	SEE FIGURE 13
---	-------	---------------

on characteristics

DC Current Gain ( $I_C = 1.5A, V_{CE} = 2V$ ) ( $I_C = 3A, V_{CE} = 2V$ )	$h_{FE}$	2000 1000	— —	12000 —	—
Collector-Emitter Saturation Voltage ( $I_C = 1.5A, I_B = 3mA$ )	$V_{CE(sat)}$	—	—	1.5	Volts
Base-Emitter Saturation Voltage ( $I_C = 1.5A, I_B = 3mA$ )	$V_{BE(sat)}$	—	—	2.0	Volts

switching characteristics

Turn-on Time	$V_{CC} = 30V$ $I_{B1} = -I_{B2} = 3mA$ Duty Cycle = 1%	$t_{on}$	—	0.3	—	$\mu S$
Storage Time		$t_{stg}$	—	2	—	
Fall Time		$t_f$	—	0.4	—	

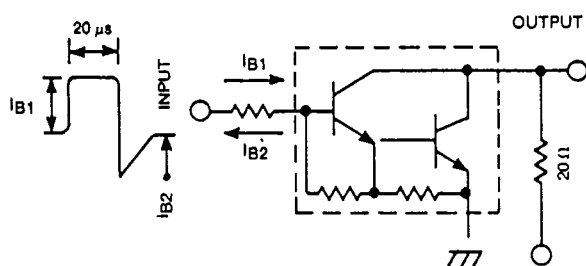

FIG. 1 SWITCHING TIME TEST CIRCUIT

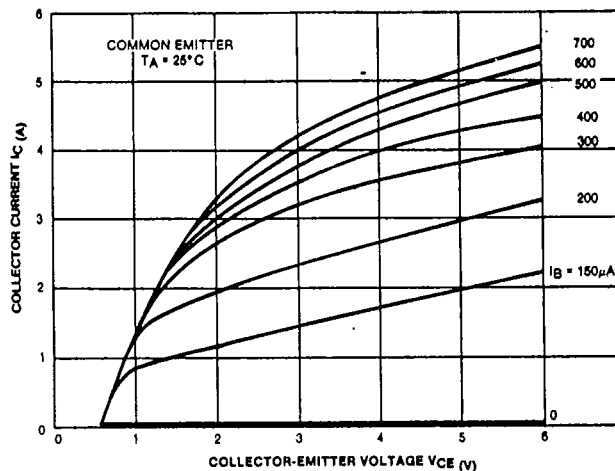

FIG. 2  $I_C - V_{CE}$

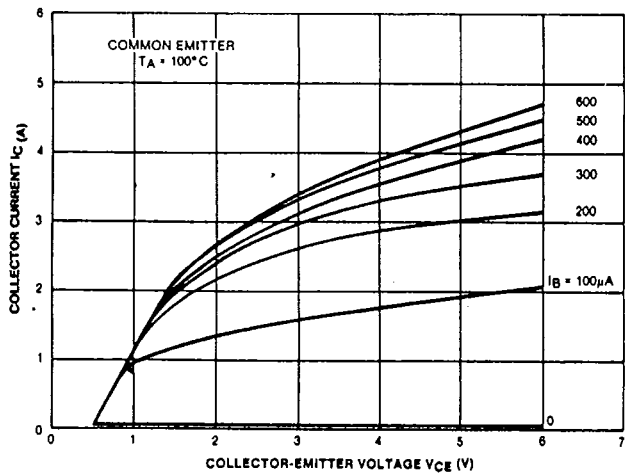

FIG. 3  $I_C - V_{CE}$

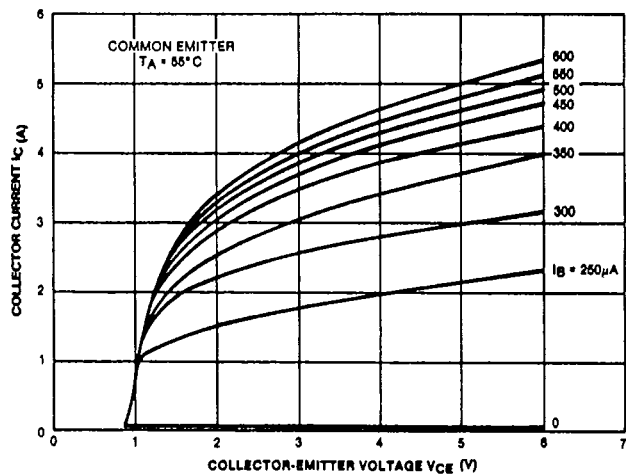

FIG. 4  $I_C - V_{CE}$

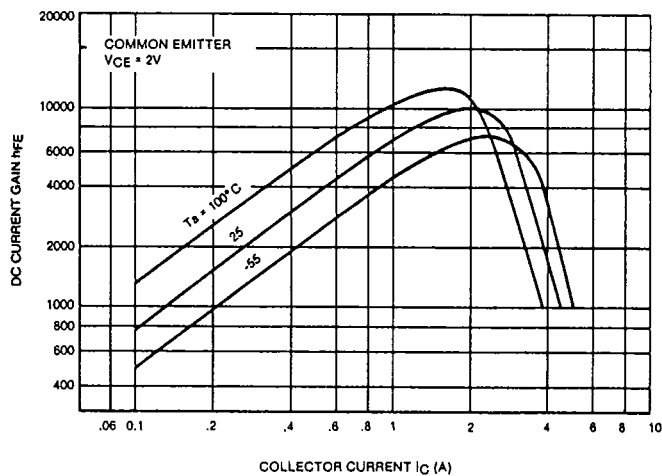

FIG. 5  $h_{FE} - I_C$

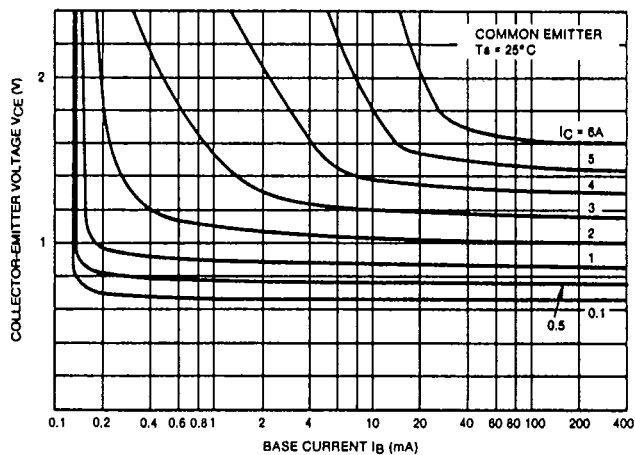

FIG. 6

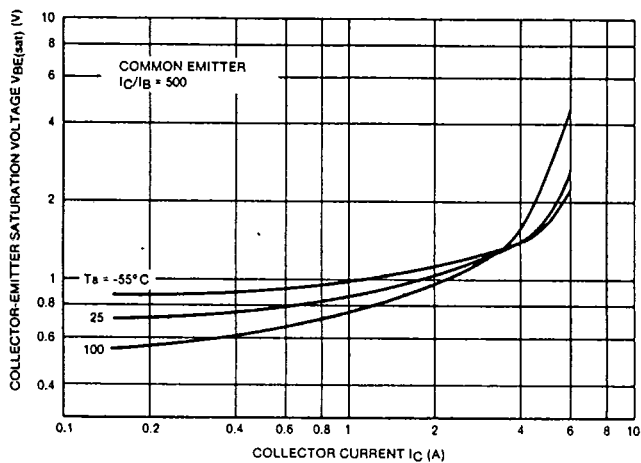

FIG. 7  $V_{CE(sat)} - I_C$

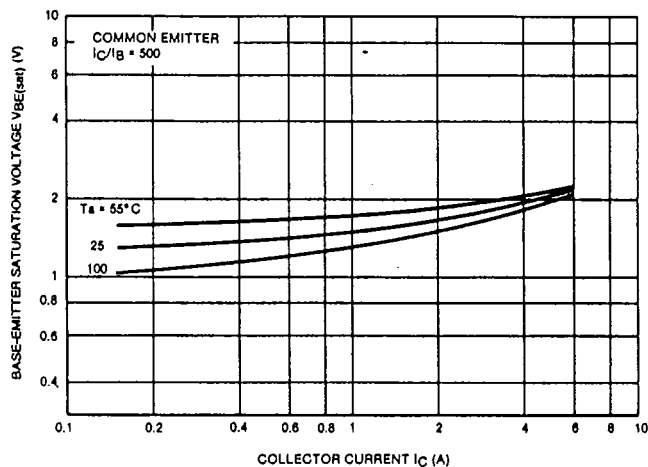

FIG. 8  $V_{BE(sat)} - I_C$

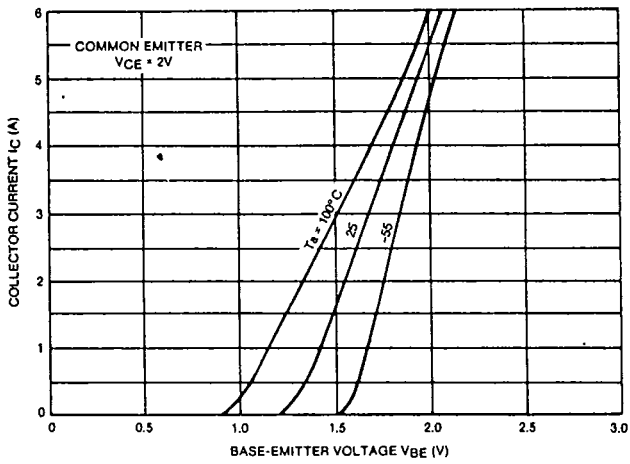

FIG. 9  $I_C - V_{BE}$

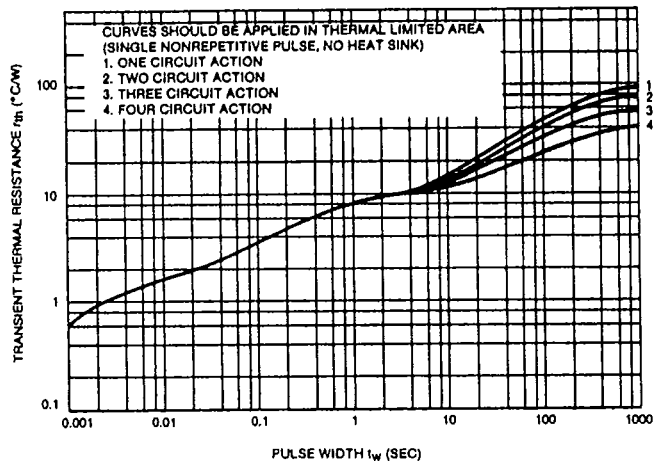

FIG. 10  $r_{th} - t_w$

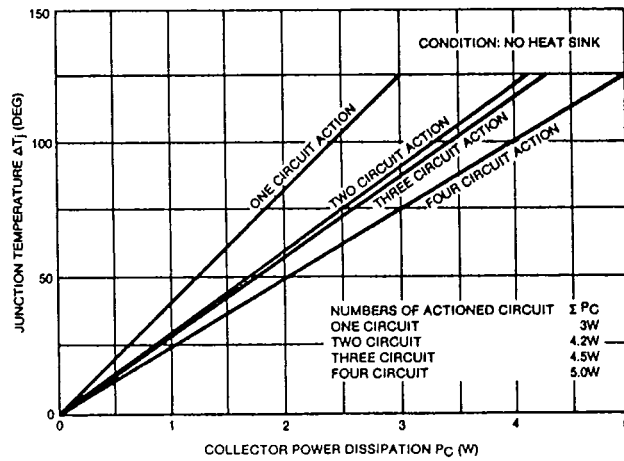

FIG. 11

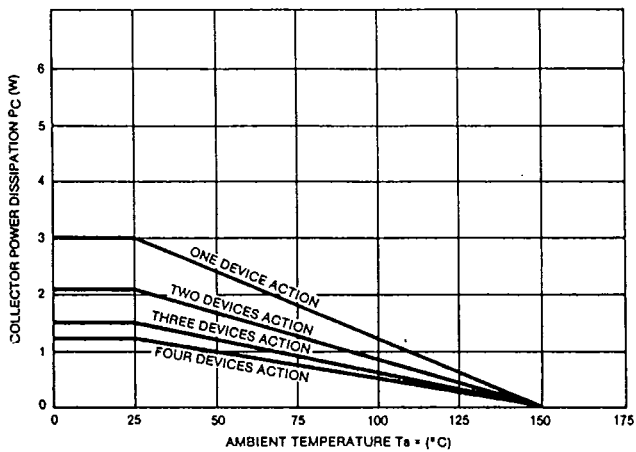

FIG. 12  $P_C - T_a$

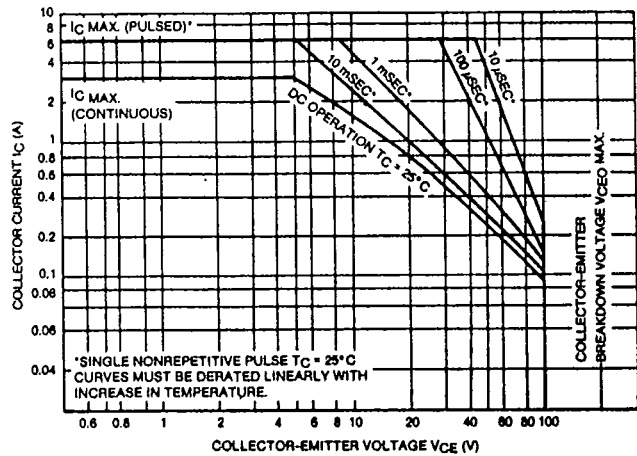

FIG. 13 SAFE OPERATING AREA



# NPN POWER DARLINGTON TRANSISTOR ARRAY

**D78A3D1**

**100 VOLTS  
3 AMP, 25 WATTS**

Designed for high power switching applications, hammer drive, pulse motor drive and inductive load drive applications.

**Features:**

- High reliability small-sized available (4 in 1)
- Epoxy single-inline package with heat sink (12 pin)
- High collector power dissipation:  $P_D = 25W @ T_A = 25^\circ C$  (Four device action)
- High collector current:  $I_C = 3A$  (Max.)
- High DC current gain:  $h_{FE} = 2000$  (Min.) @  $V_{CE} = 2V, I_C = 1.5A$

ARRAY CONFIGURATION

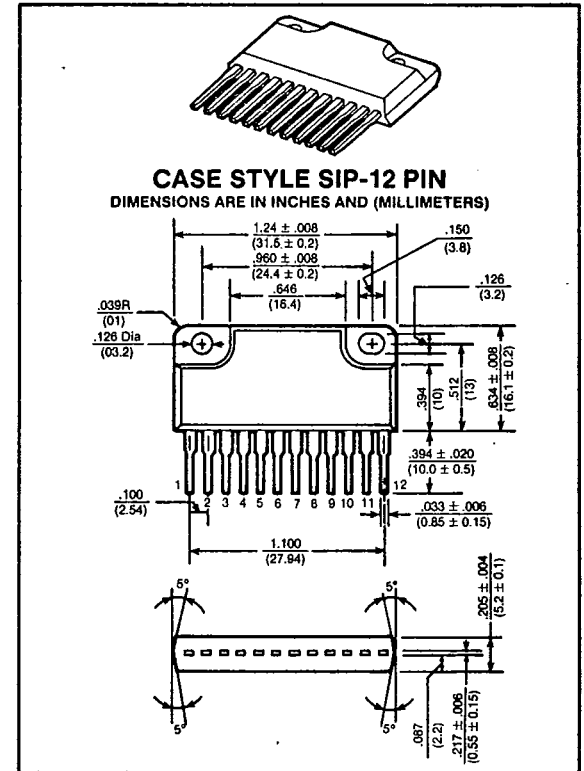
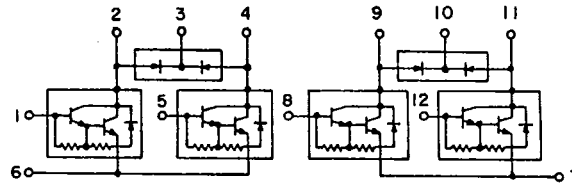

maximum ratings ( $T_A = 25^\circ C$ ) (unless otherwise specified)

RATING	SYMBOL	D78A3D1	UNITS
Collector-Emitter Voltage	$V_{CEO}$	100	Volts
Collector-Base Voltage	$V_{CBO}$	120	Volts
Emitter Base Voltage	$V_{EBO}$	6	Volts
Collector Current — Continuous	$I_C$	3	A
Peak	$I_{CM}$	6	A
Base Current — Continuous	$I_B$	0.5	A
Maximum Forward Current	$I_{FM}$	3	A
Surge Current (1 sec)	$I_{FSM}$	6	A
Reverse Voltage	$V_R$	100	A
Collector Power Dissipation (One Device Action, $T_A = 25^\circ C$ )	$P_D$	3.0	Watts
Collector Power Dissipation (Four Device Action)	$P_D$	$T_A, 25^\circ C$ $T_C = 25^\circ C$ 5.0 25	Watts
Isolation Voltage (Between Fin to 1 ~ 12 pin)	$V_{Isol}$	1000	Volts
Operating and Storage Junction Temperature Range	$T_J, T_{STG}$	-55 to +150	$^\circ C$