

SHINDENGEN

Super Fast Recovery Rectifiers

Dual

D8LD20U

200V 8A

FEATURES

- Low noise
- trr35ns
- Fully Isolated Molding

APPLICATION

- Switching power supply
- Free Wheel
- Home Appliances, Office Equipment
- Telecommunication, Factory Automation

OUTLINE DIMENSIONS

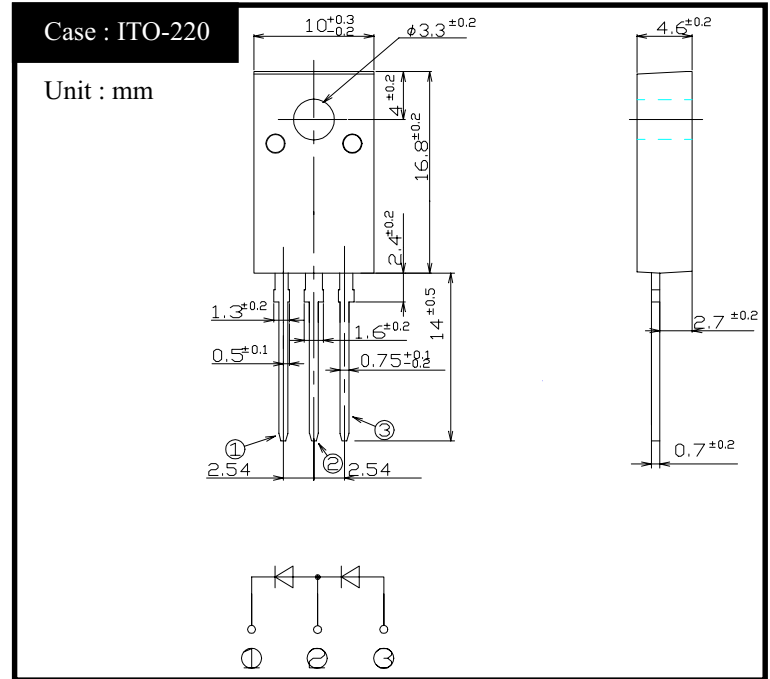

RATINGS

● Absolute Maximum Ratings (If not specified T_c=25°C)

Item	Symbol	Conditions	Ratings	Unit
Storage Temperature	T _{stg}		-40~150	°C
Operating Junction Temperature	T _j		150	°C
Maximum Reverse Voltage	V _{RM}		200	V
Average Rectified Forward Current	I _O	50Hz sine wave, R-load, Rating for each diode I _O /2, T _c =122°C	8	A
Peak Surge Forward Current	I _{FSM}	50Hz sine wave, Non-repetitive 1 cycle peak value, T _j =25°C	60	A
Dielectric Strength	V _{dis}	Terminals to case, AC 1 minute	1.5	kV
Mounting Torque	TOR	(Recommended torque:0.3N·m)	0.5	N·m

● Electrical Characteristics (If not specified T_c=25°C)

Item	Symbol	Conditions	Ratings	Unit
Forward Voltage	V _F	I _F =4A, Pulse measurement, Rating of per diode	Max.0.98	V
Reverse Current	I _R	V _R =V _{RM} , Pulse measurement, Rating of per diode	Max.10	μA
Reverse Recovery Time	trr	I _F =0.5A, I _R =1A, Rating of per diode	Max.35	ns
Thermal Resistance	θ _{jc}	junction to case	Max.3.3	°C/W

D8LD20U

Forward Voltage

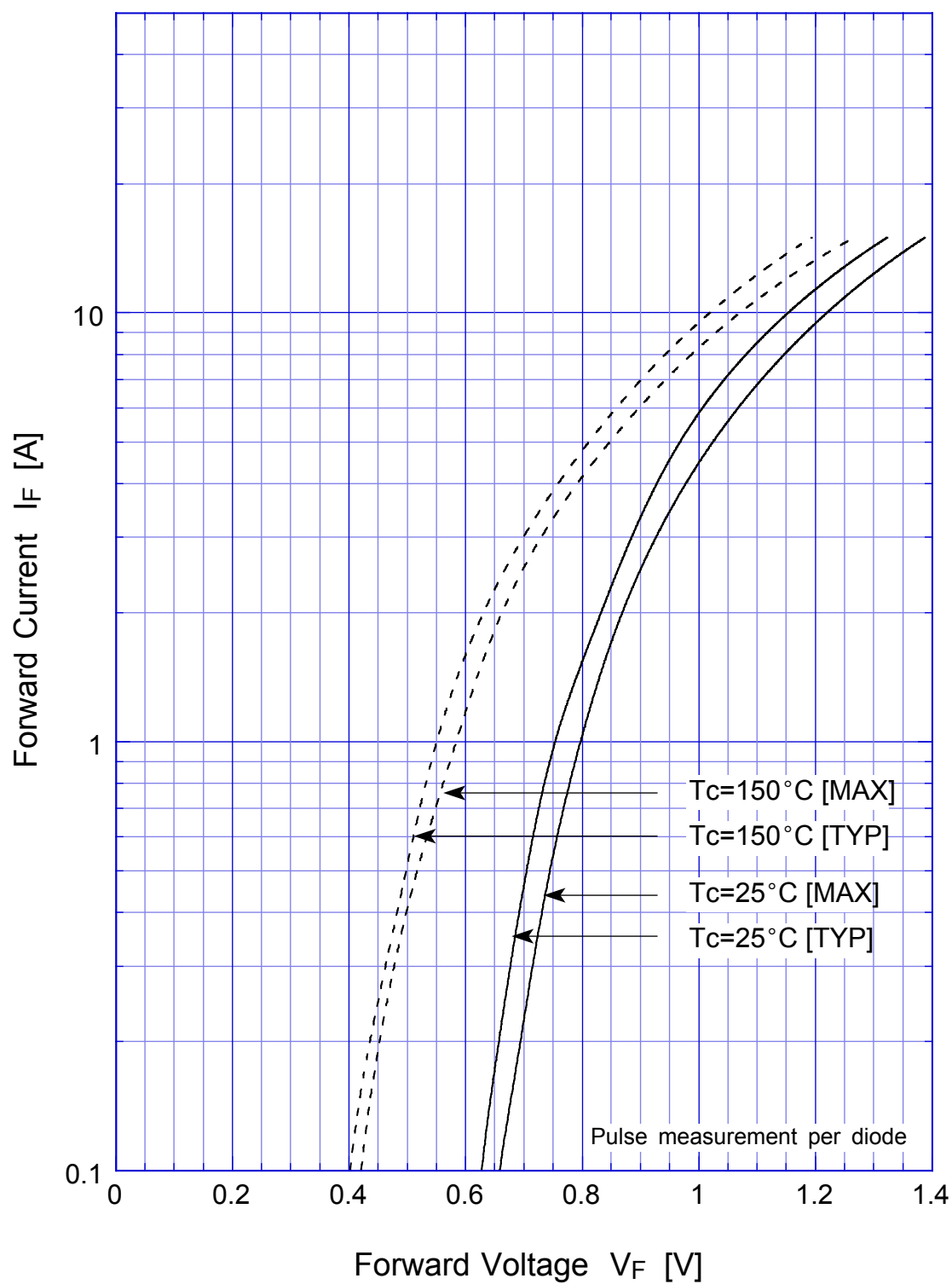

D8LD20U Forward Power Dissipation

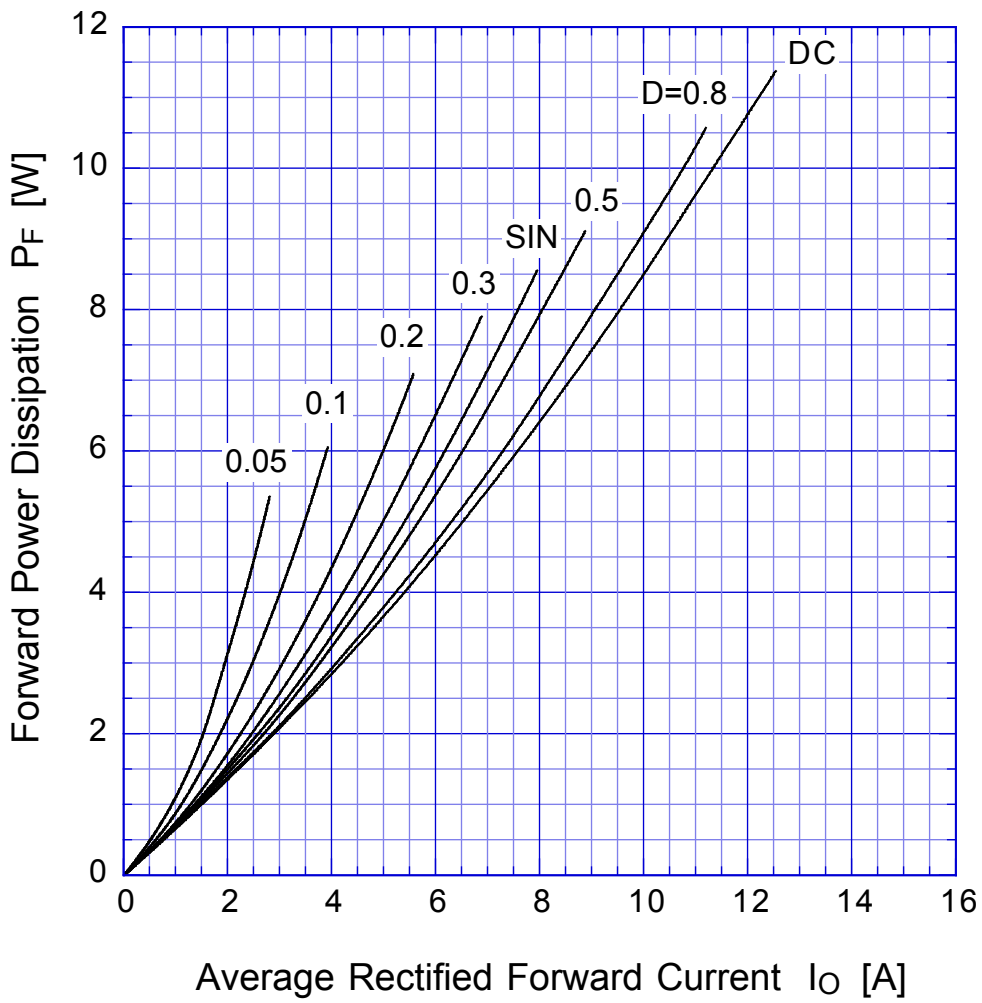

$T_j = T_{jmax}$

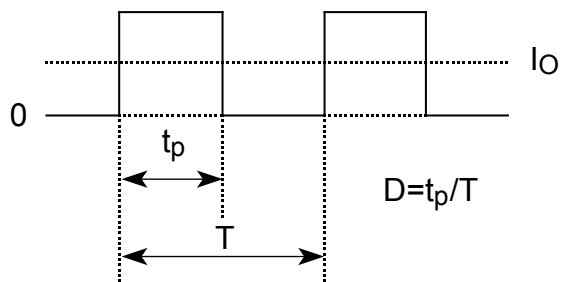

D8LD20U

Derating Curve

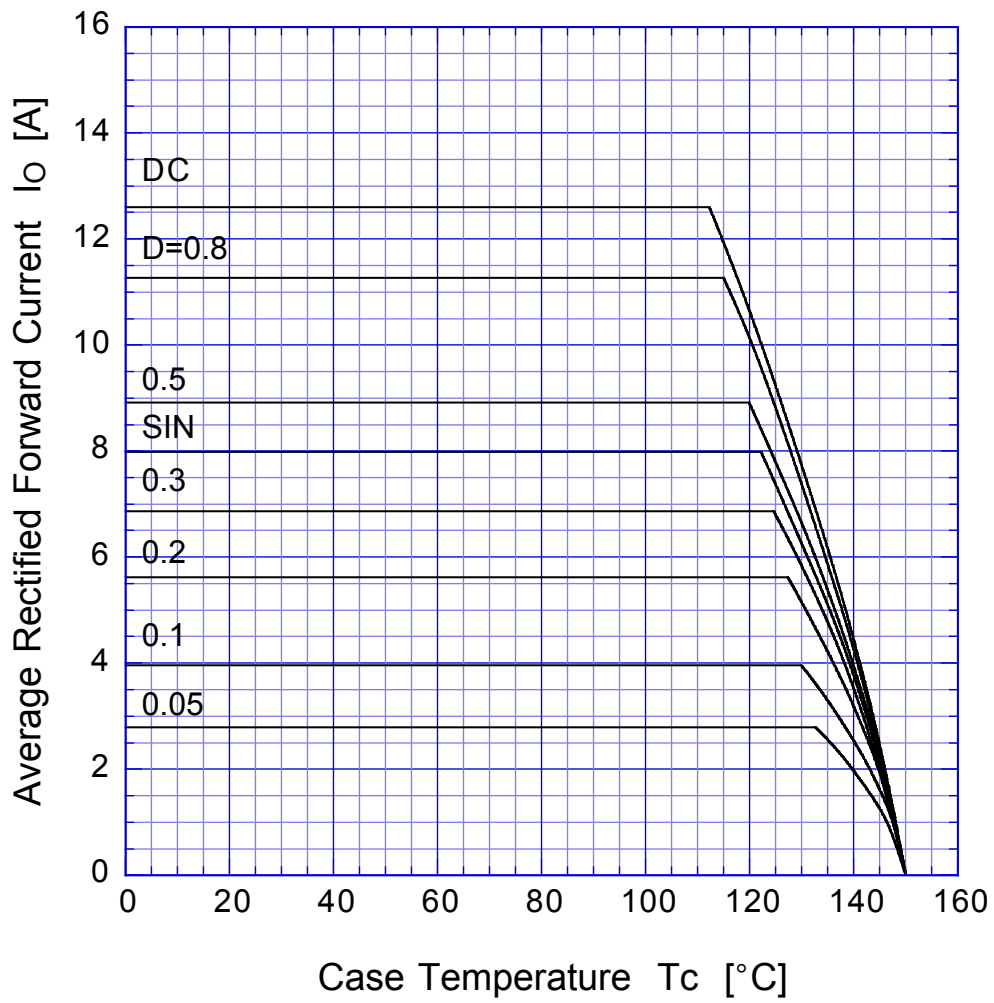

$$V_R = V_{RM}$$



D8LD20U

Derating Curve

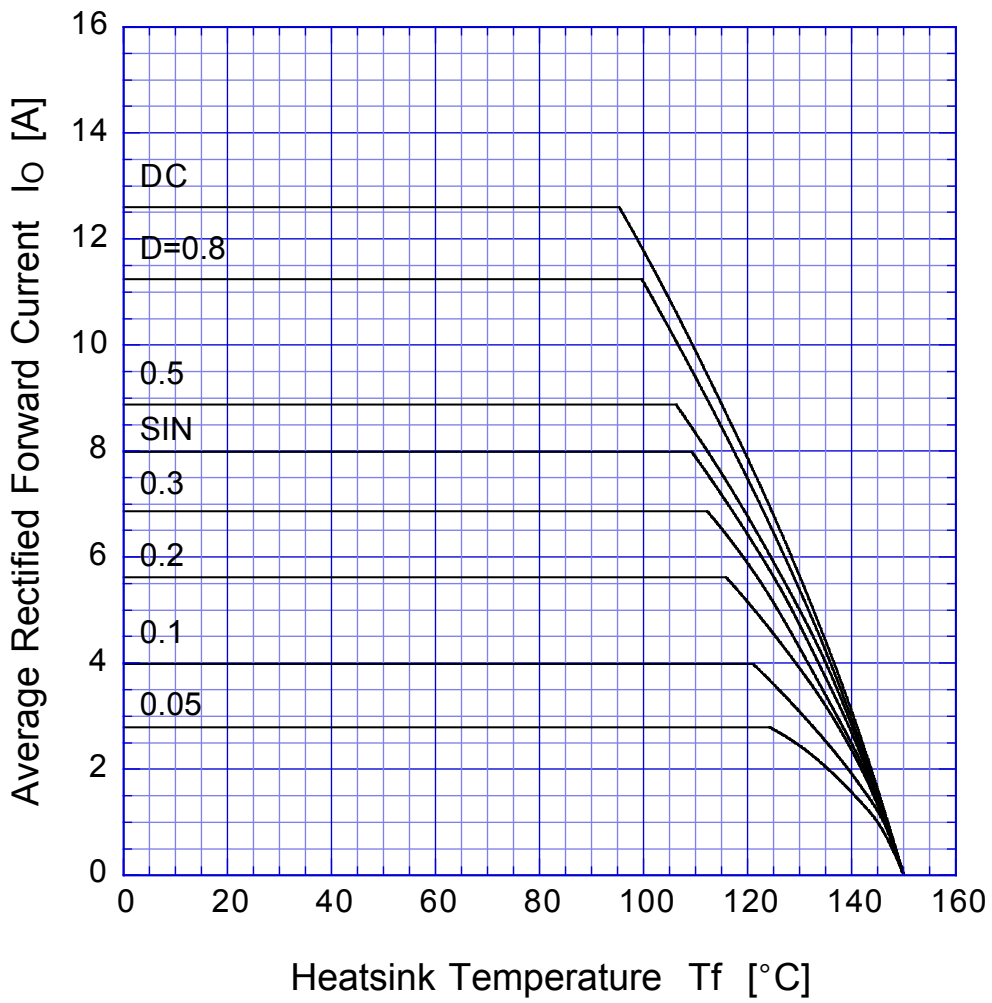

$$V_R = V_{RM}$$



D8LD20U Peak Surge Forward Capability

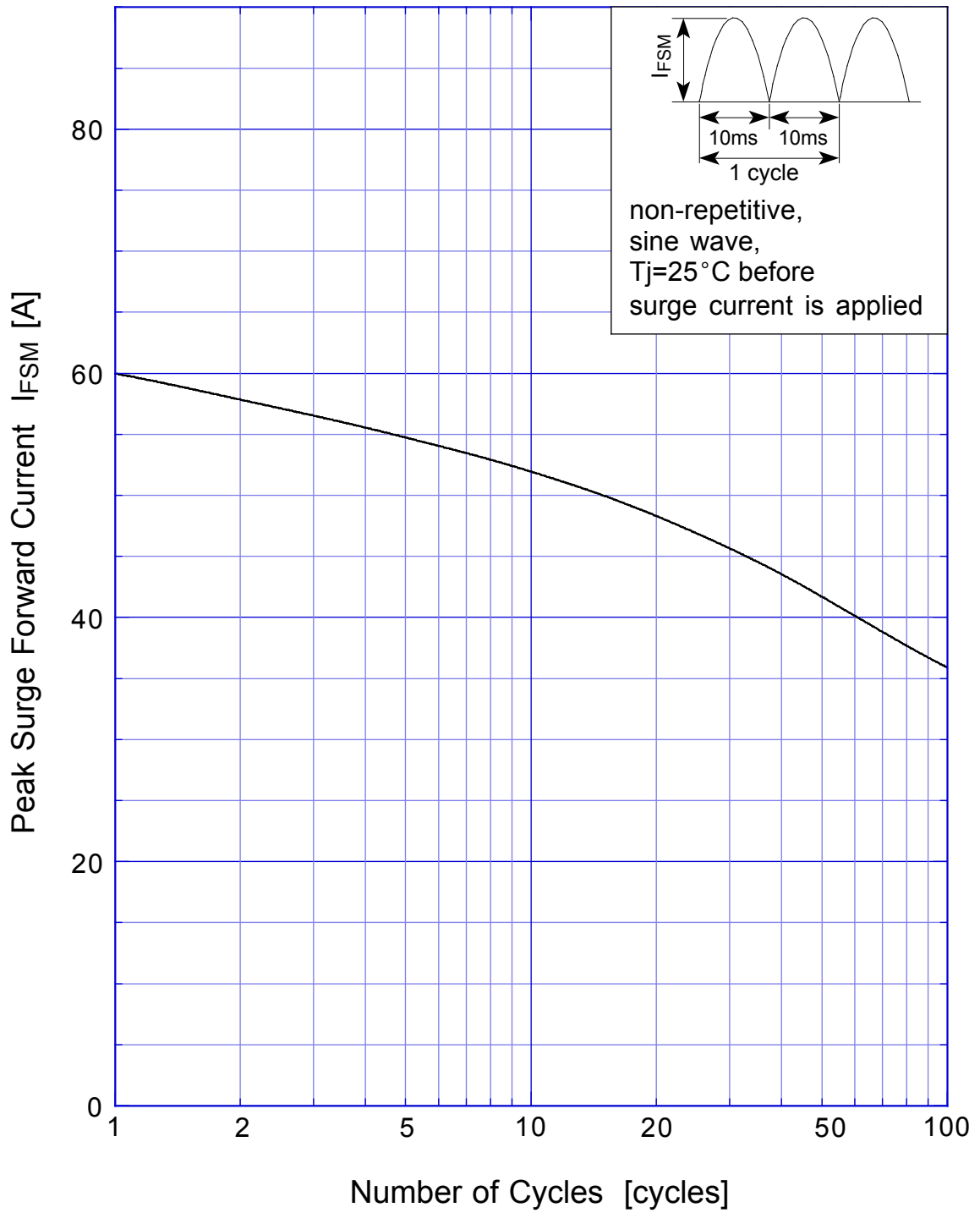

D8LD20U Junction Capacitance

