

DE3L40

Forward Voltage

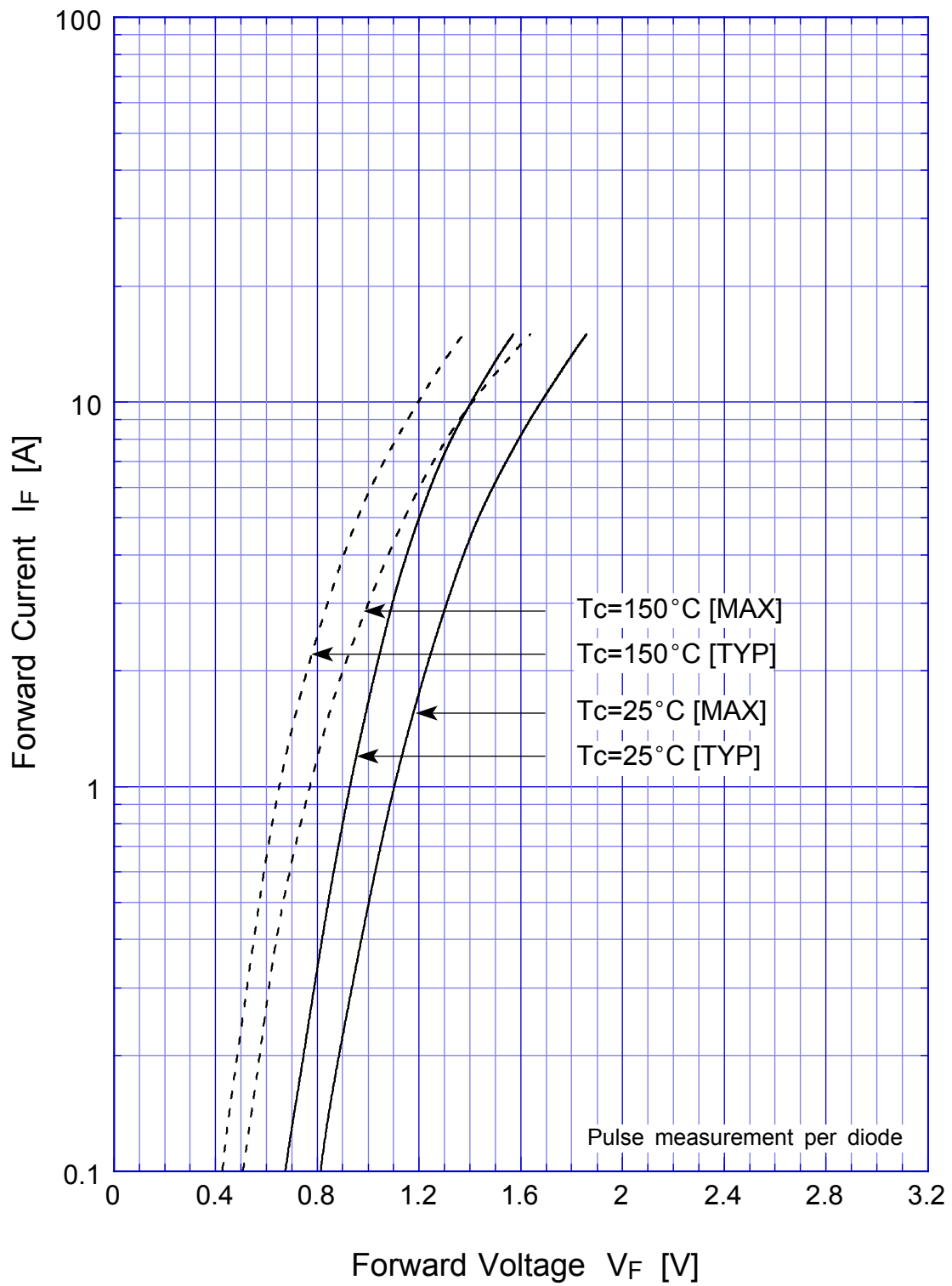

DE3L40

Forward Power Dissipation

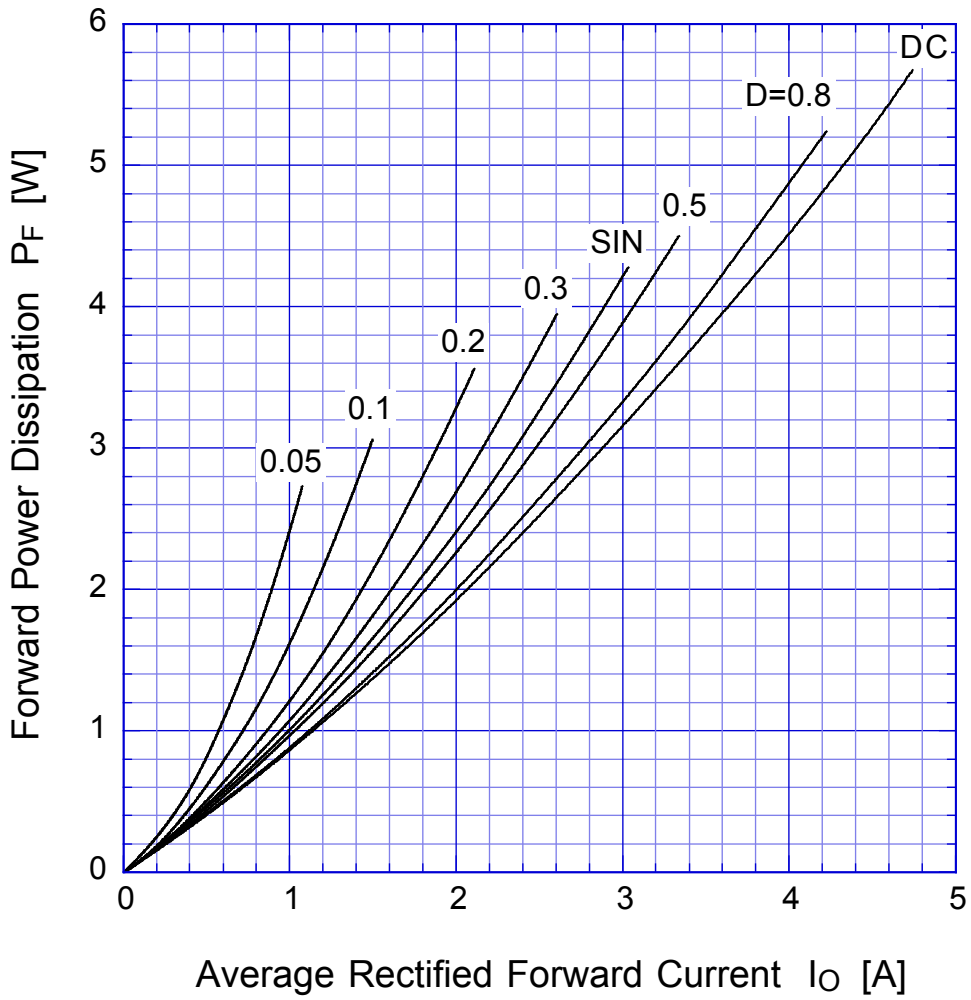

$T_j = T_{jmax}$

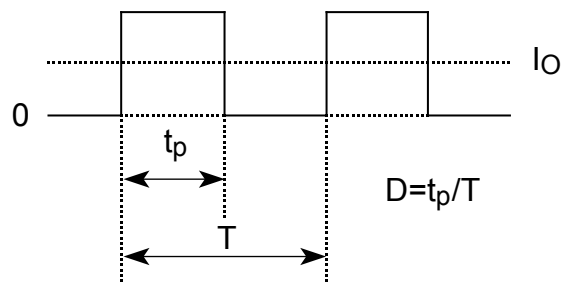

DE3L40

Derating Curve

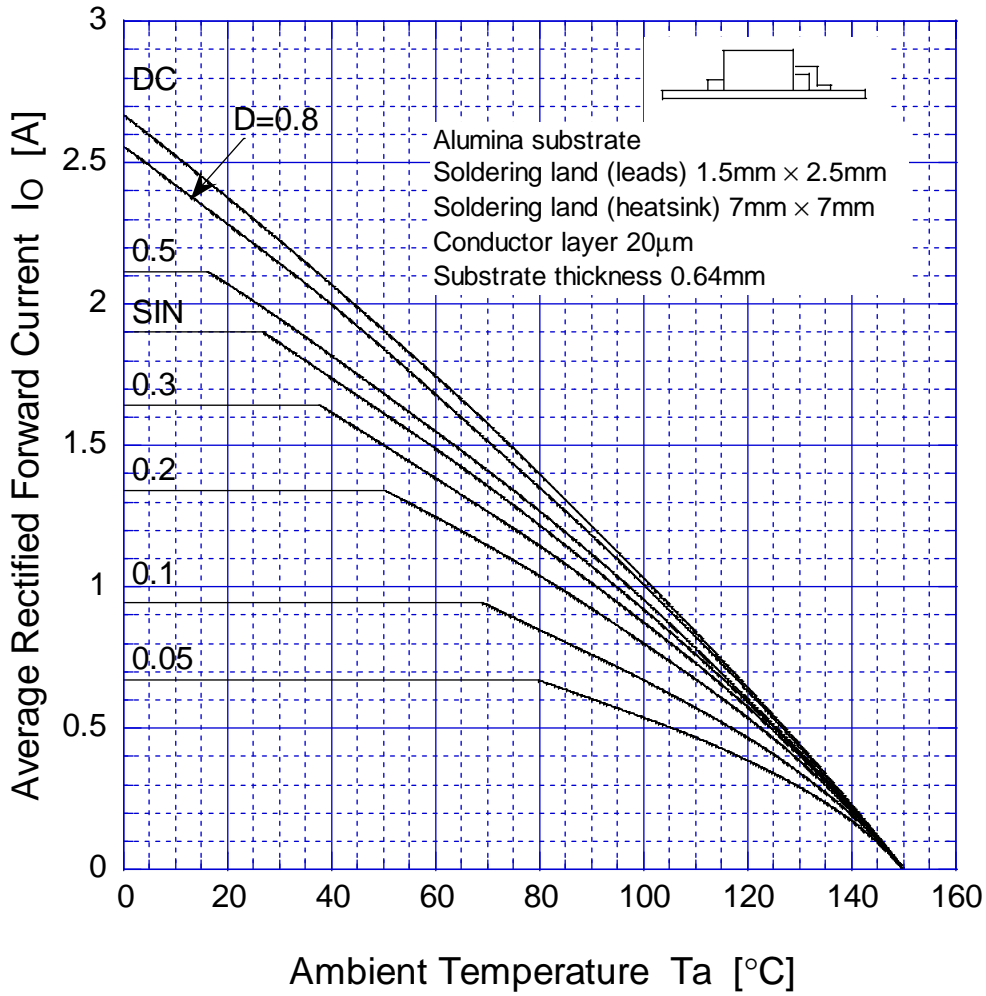

$$V_R = V_{RM}$$

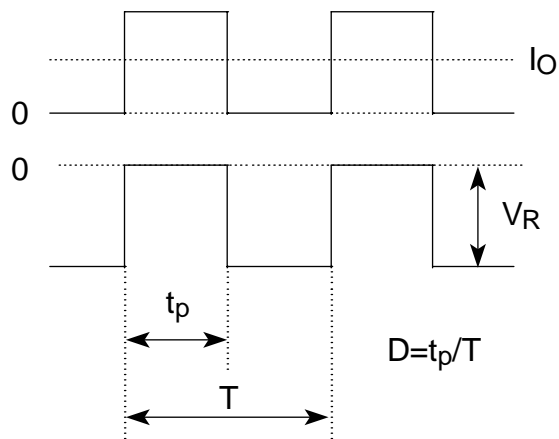

DE3L40

Derating Curve

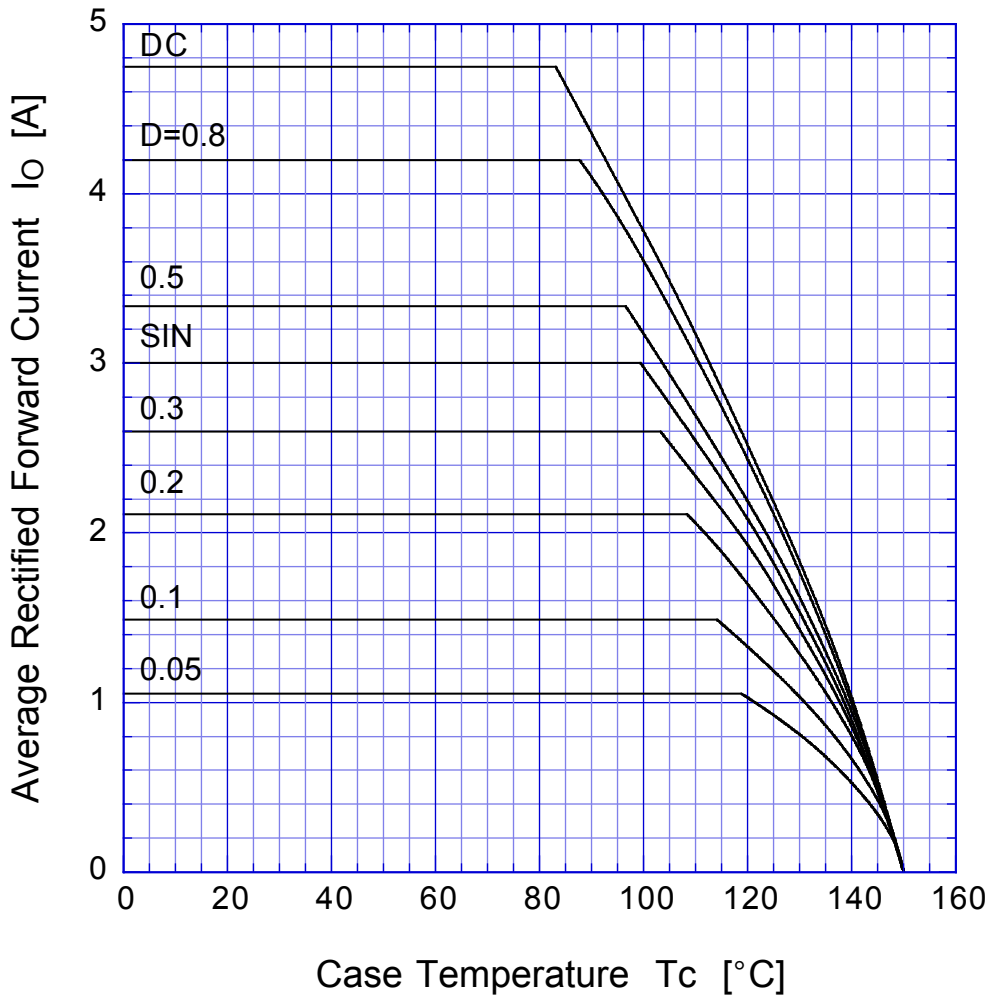

$$V_R = V_{RM}$$



DE3L40

Peak Surge Forward Capability

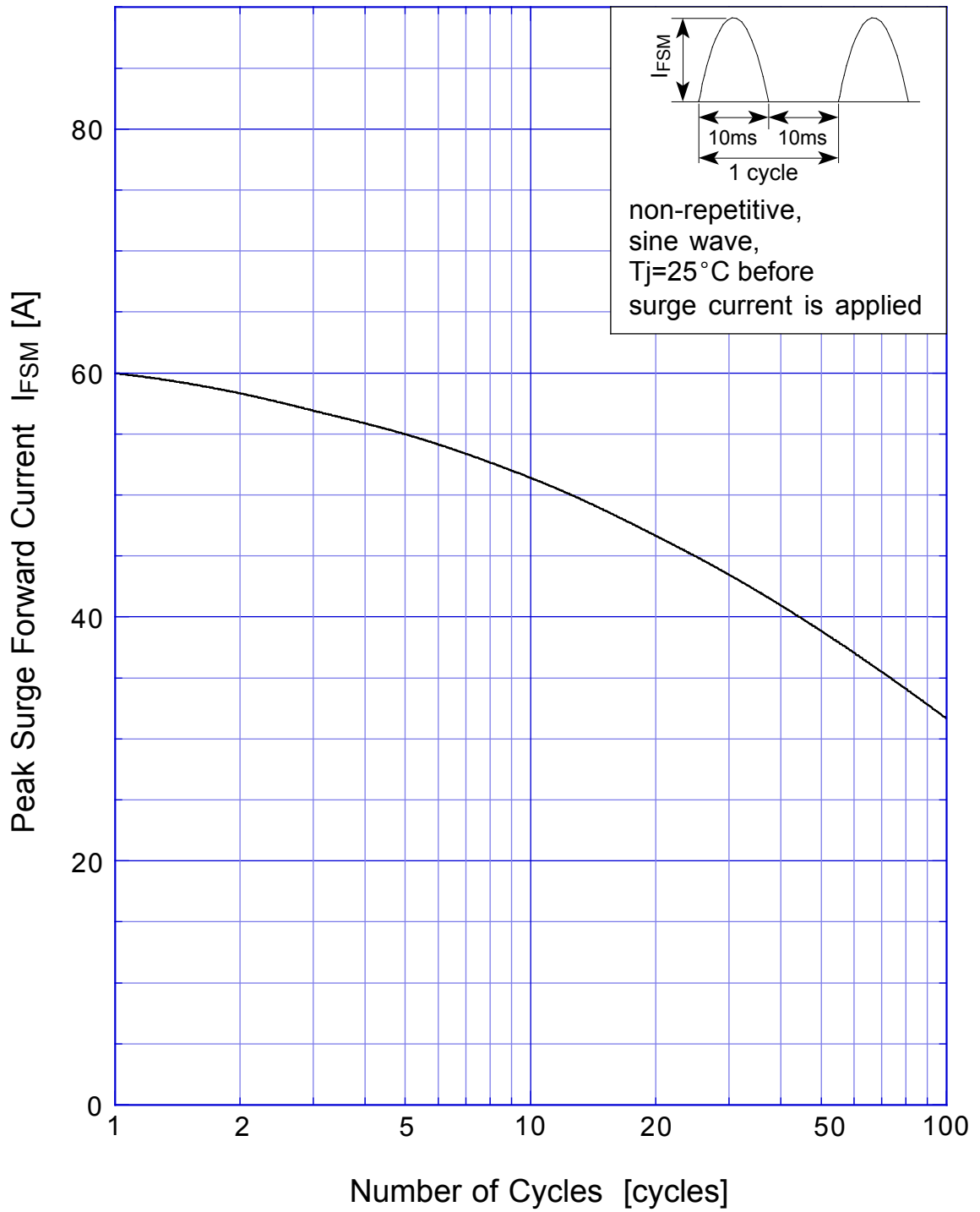

DE3L40 Junction Capacitance

