

SHINDENGEN

Super Fast Recovery Rectifiers

Single

DF20L60U

600V 20A

OUTLINE DIMENSIONS

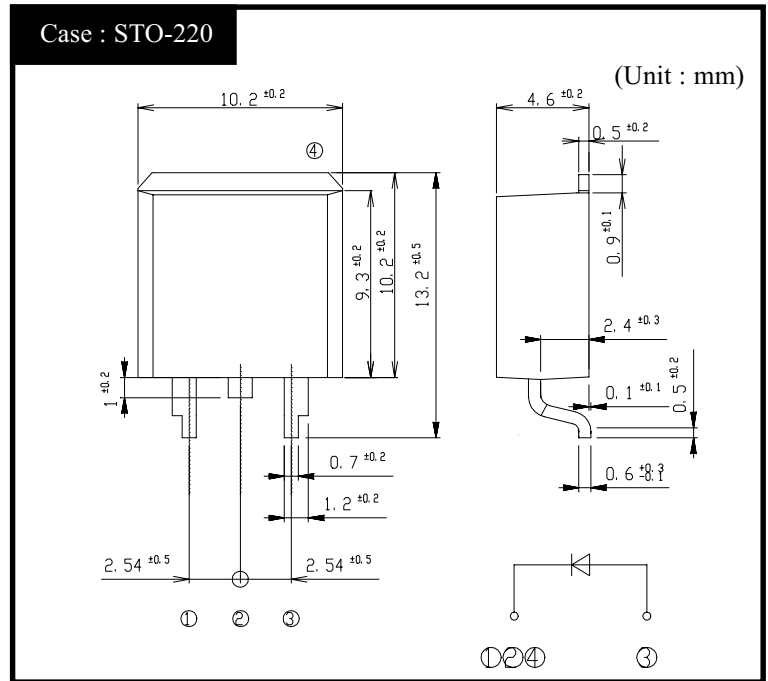

RATINGS

●Absolute Maximum Ratings (Tc=25°C)

Item	Symbol	Conditions	Ratings	Unit
Storage Temperature	Tstg		-55~150	°C
Operating Junction Temperature	Tj		150	°C
Maximum Reverse Voltage	VRM		600	V
Average Rectified Forward Current	Io	50Hz sine wave, R-load Tc=93°C	20	A
Peak Surge Forward Current	IFSM	50Hz sine wave, Non-repetitive 1 cycle peak value, Tj=25°C	160	A

●Electrical Characteristics Tc=25°C

Item	Symbol	Conditions	Ratings	Unit
Forward Voltage	VF	IF=20A, Pulse measurement	Max.3.0	V
Reverse Current	IR	VR=VRM, Pulse measurement	Max.25	μA
Reverse Recovery Time	trr	IF=0.5A, IR=1.0A	Max.35	ns
Junction Capacitance	Cj	f=1MHz, VR=10V	Typ.105	pF
Thermal Resistance	θjc	junction to case	Max.0.9	°C/W

DF20L60U Forward Voltage

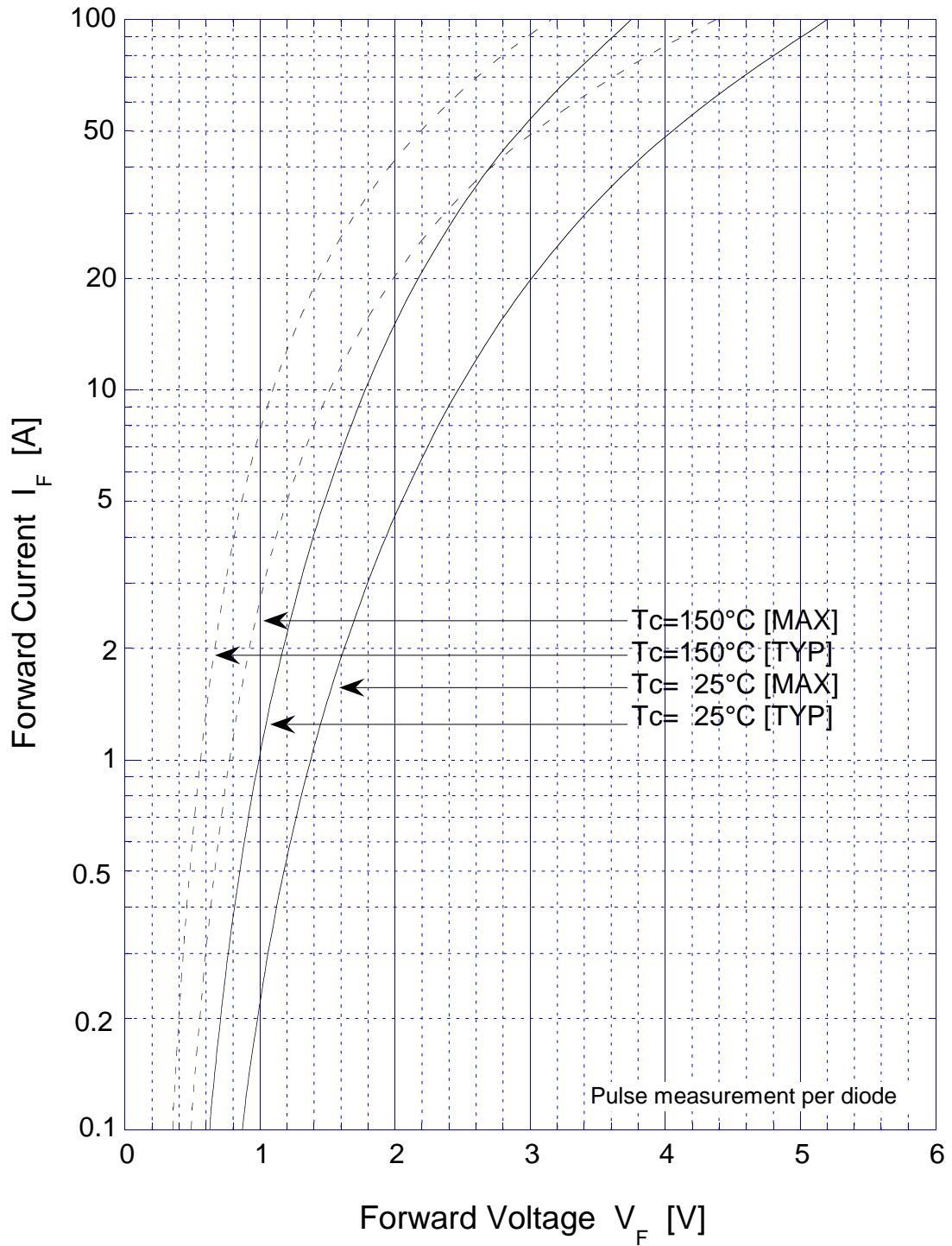

DF20L60U Forward Power Dissipation

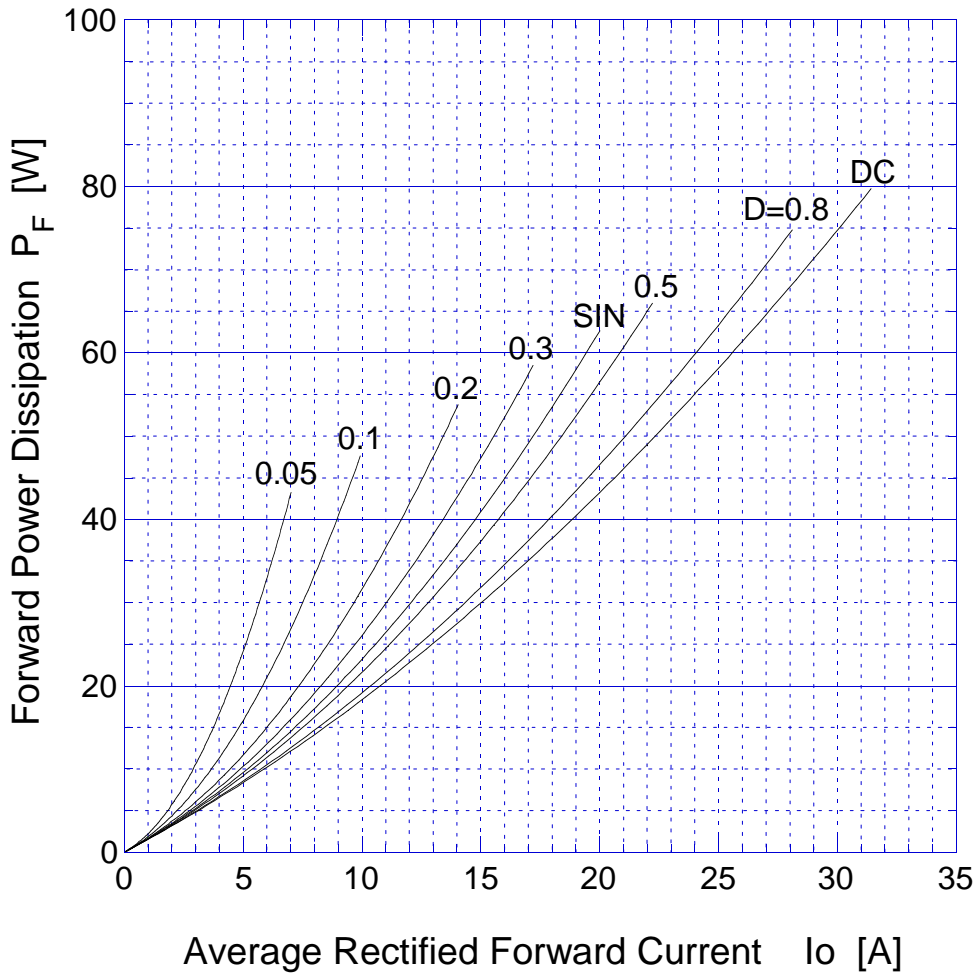

$T_j = 150^\circ\text{C}$

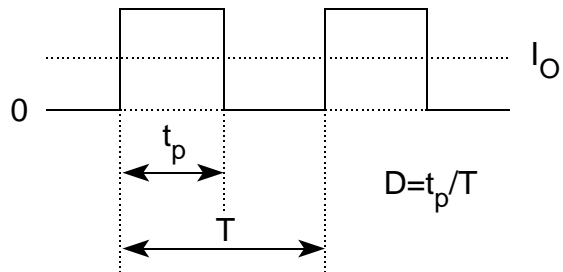

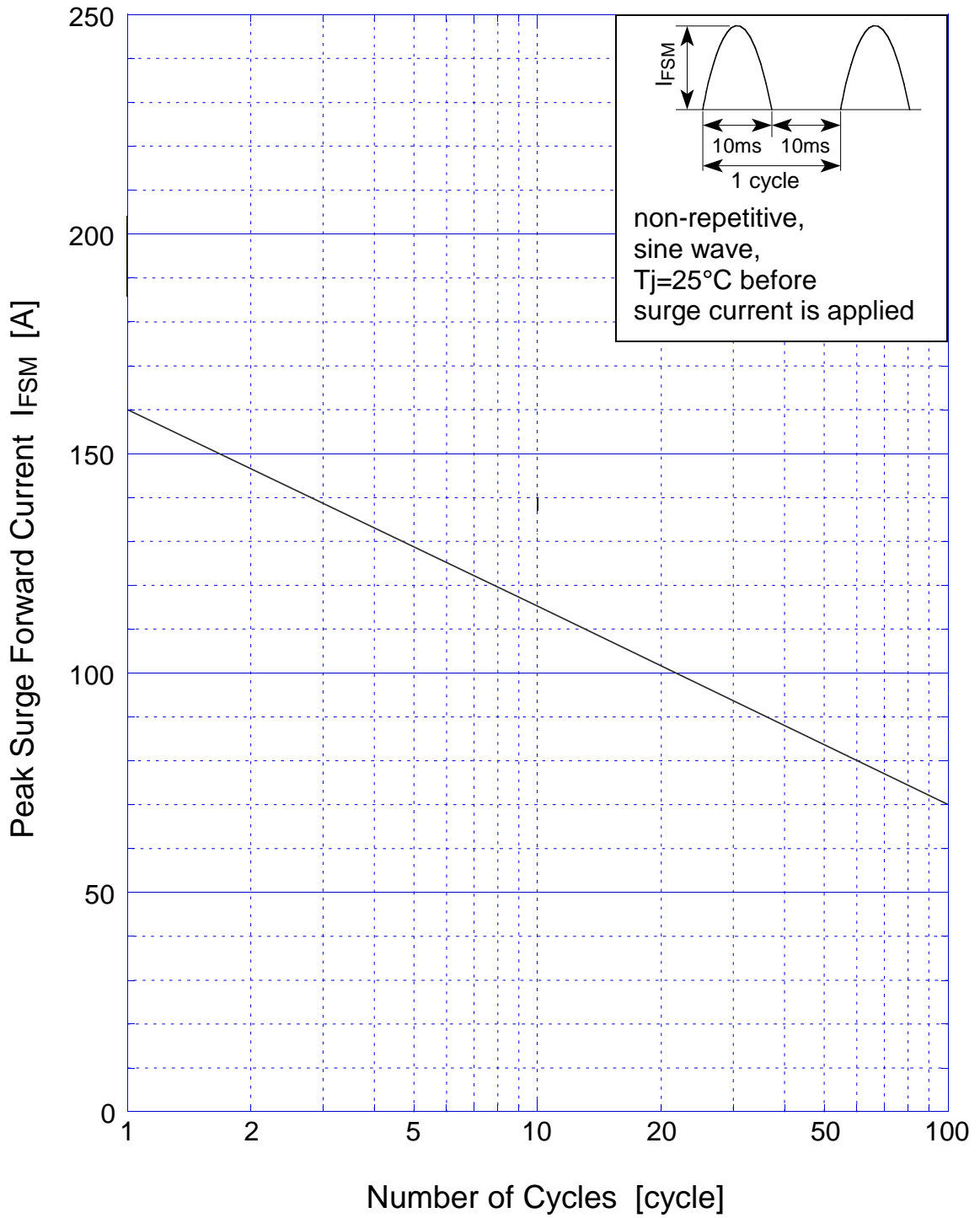

DF20L60U Reverse Current

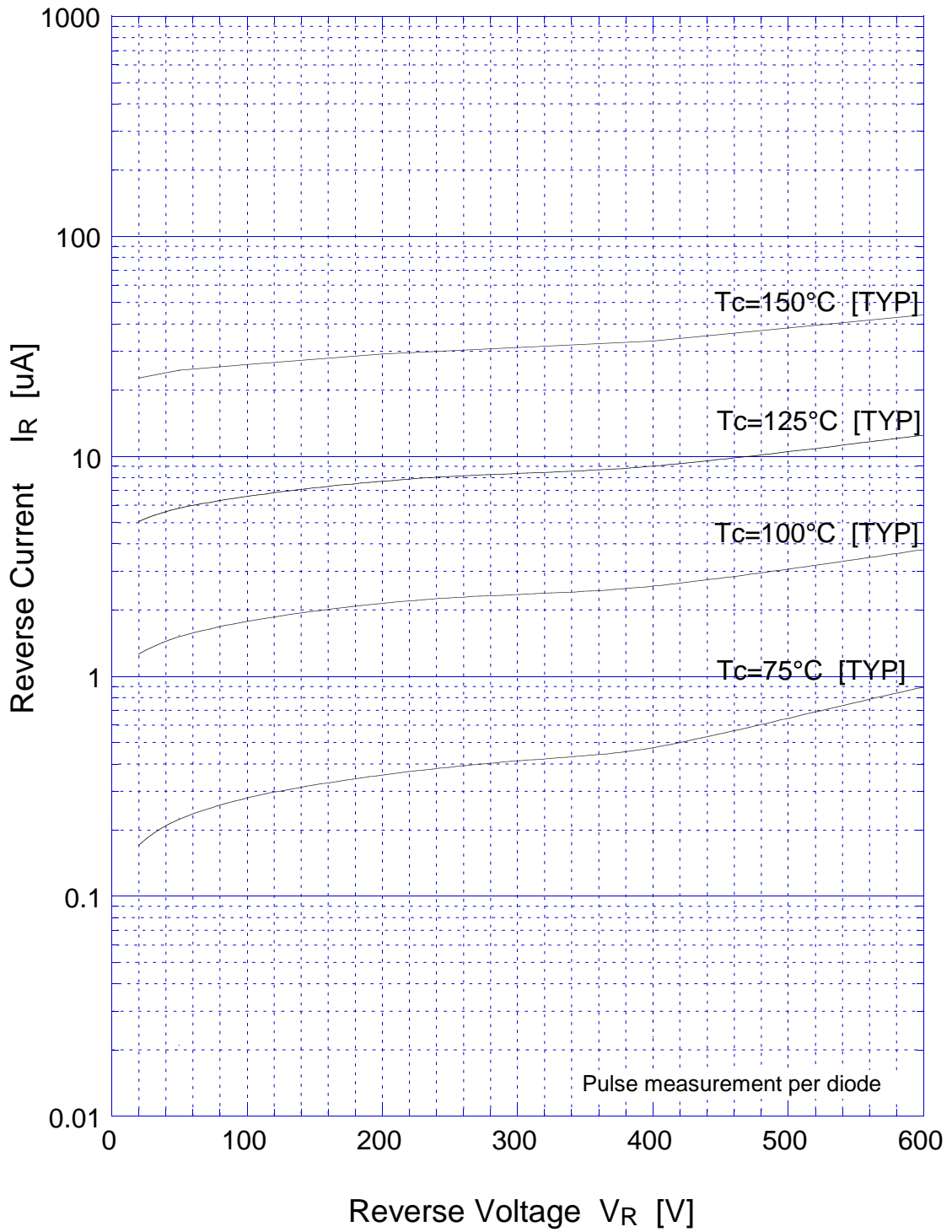

DF20L60U Junction Capacitance

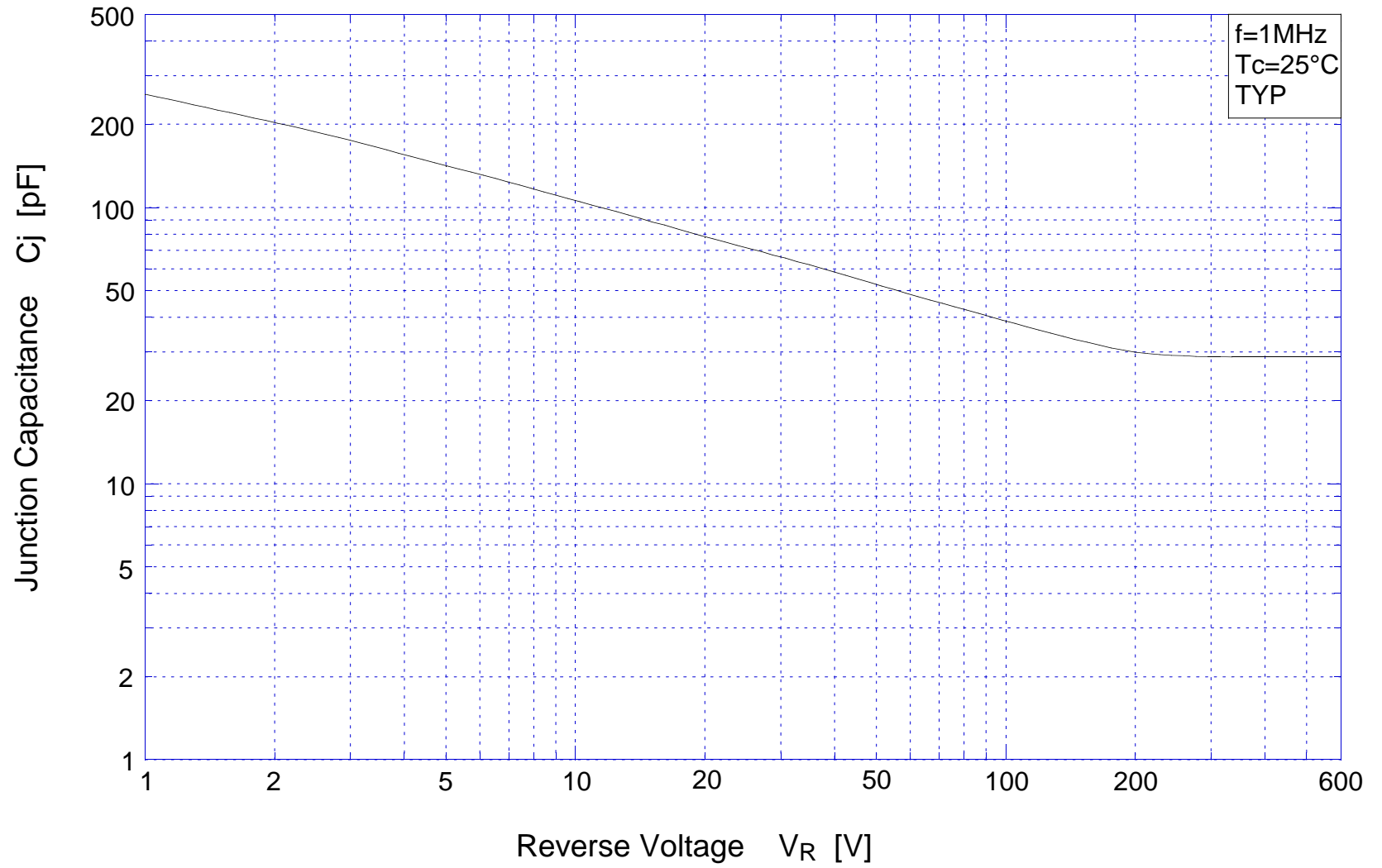

DF20L60U

Derating Curve

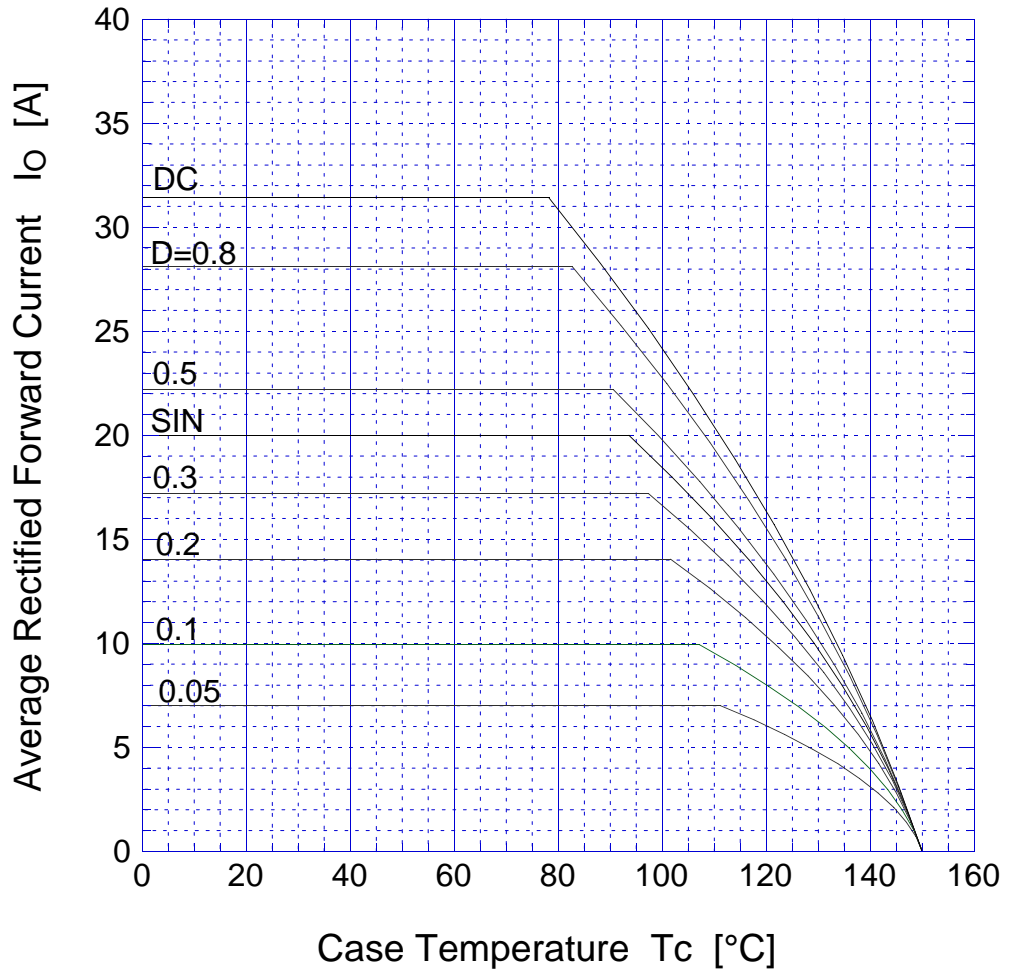

$$V_R = V_{RM}$$

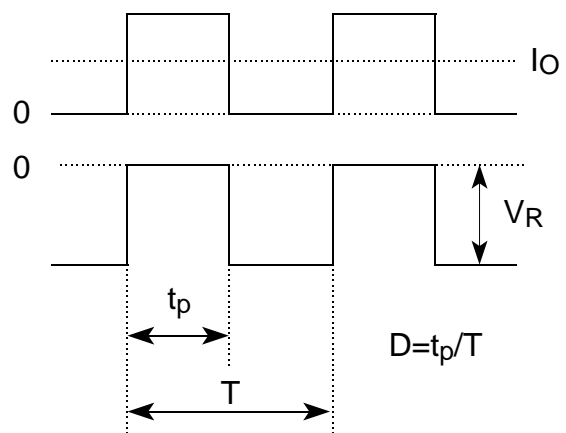

DF20L60U Transient Thermal Impedance

