

DM74ALS86 Quad 2-Input Exclusive-OR Gate

General Description

This device contains four independent gates, each of which performs the logic exclusive-OR function.

Features

- Switching specifications at 50 pF
- Switching specifications guaranteed over full temperature and V_{CC} range

- Advanced oxide-isolated, ion-implanted Schottky TTL process
- Functionally and pin for pin compatible with Schottky and low power Schottky TTL counterpart
- Improved AC performance over Schottky and low power Schottky counterparts

Connection Diagram

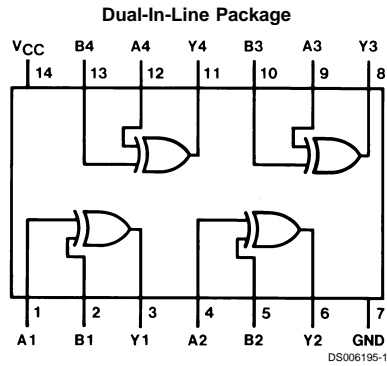

Order Number DM74ALS86M or DM74ALS86N
See Package Number M14A or N14A

Function Table

$$Y = A \oplus B = \bar{A} B + A \bar{B}$$

Inputs		Output
A	B	Y
L	L	L
L	H	H
H	L	H
H	H	L

H = High Logic Level
L = Low Logic Level

Absolute Maximum Ratings (Note 1)

Supply Voltage	7V
Input Voltage	7V
Operating Free Air Temperature Range	0°C to +70°C
DM74ALS	

Storage Temperature Range

-65°C to +150°C

Typical θ_{JA}

N Package

87.0°C/W

M Package

117.2°C/W

Recommended Operating Conditions

Symbol	Parameter	DM74ALS86			Units
		Min	Nom	Max	
V_{CC}	Supply Voltage	4.5	5	5.5	V
V_{IH}	High Level Input Voltage	2			V
V_{IL}	Low Level Input Voltage			0.8	V
I_{OH}	High Level Output Current			-0.4	mA
I_{OL}	Low Level Output Current			8	mA
T_A	Free Air Operating Temperature	0		70	°C

Note 1: The "Absolute Maximum Ratings" are those values beyond which the safety of the device cannot be guaranteed. The device should not be operated at these limits. The parametric values defined in the "Electrical Characteristics" table are not guaranteed at the absolute maximum ratings. The "Recommended Operating Conditions" table will define the conditions for actual device operation.

Electrical Characteristics

over recommended operating free air temperature range. All typical values are measured at $V_{CC} = 5V$, $T_A = 25^\circ C$.

Symbol	Parameter	Conditions	Min	Typ	Max	Units
V_{IK}	Input Clamp Voltage	$V_{CC} = 4.5V$, $I_I = -18 mA$			-1.5	V
V_{OH}	High Level Output Voltage	$I_{OH} = -0.4 mA$ $V_{CC} = 4.5V$ to $5.5V$	$V_{CC} - 2$			V
V_{OL}	Low Level Output Voltage	$V_{CC} = 4.5V$	$I_{OL} = 4 mA$	0.25	0.4	V
			$I_{OL} = 8 mA$	0.35	0.5	V
I_I	Input Current @ Max. Input Voltage	$V_{CC} = 5.5V$, $V_{IH} = 7V$			0.1	mA
I_{IH}	High Level Input Current	$V_{CC} = 5.5V$, $V_{IH} = 2.7V$			20	μA
I_{IL}	Low Level Input Current	$V_{CC} = 5.5V$, $V_{IL} = 0.4V$			-0.1	mA
I_O	Output Drive Current	$V_{CC} = 5.5V$, $V_O = 2.25V$	-30		-112	mA
I_{CCL}	Supply Current with Outputs Low	$V_{CC} = \text{Max}$, All Inputs at 4.5V		3.9	5.9	mA
I_{CCH}	Supply Current with Outputs High	$V_{CC} = \text{Max}$, A Inputs at 0.0V B Inputs at 4.5V		3.8	4.5	mA

Switching Characteristics

over recommended operating free air temperature range. (Note 3)

Symbol	Parameter	Conditions	DM74ALS86		Units
			Min	Max	
t_{PLH}	Propagation Delay Time Low to High Level Output	(Note 3) A or B to Y Other Input Low	3	17	ns
			2	12	ns
t_{PHL}	Propagation Delay Time High to Low Level Output	(Note 3) A or B to Y Other Input High	2	17	ns
			2	10	ns

Note 2: See Section 1 for test waveforms and output load.

Note 3: $V_{CC} = 4.5V$ to $5.5V$, $R_L = 500\Omega$, $C_L = 50 pF$.

Physical Dimensions inches (millimeters) unless otherwise noted

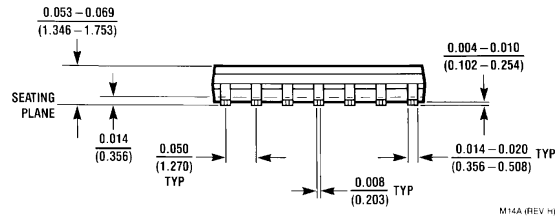
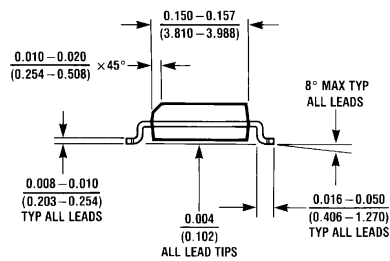
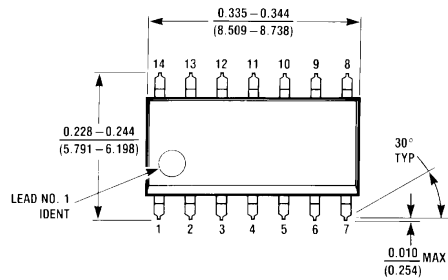

M14A (REV H)

S.O. Package (M)
Order Number DM74ALS86M
Package Number M14A

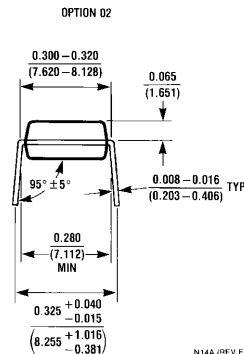
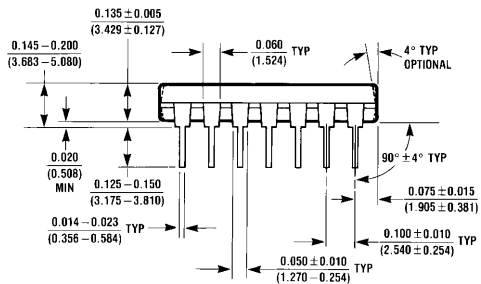
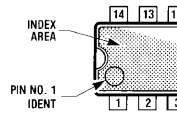
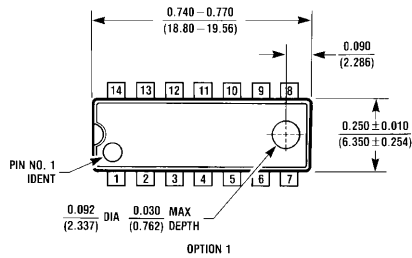

N14A (REV F)

Molded Dual-In-Line Package (N)
Order Number DM74ALS86N
Package Number N14A

LIFE SUPPORT POLICY

FAIRCHILD'S PRODUCTS ARE NOT AUTHORIZED FOR USE AS CRITICAL COMPONENTS IN LIFE SUPPORT DEVICES OR SYSTEMS WITHOUT THE EXPRESS WRITTEN APPROVAL OF THE PRESIDENT OF FAIRCHILD SEMICONDUCTOR CORPORATION. As used herein:

1. Life support devices or systems are devices or systems which, (a) are intended for surgical implant into the body, or (b) support or sustain life, and (c) whose failure to perform when properly used in accordance with instructions for use provided in the labeling, can be reasonably expected to result in a significant injury to the user.
2. A critical component in any component of a life support device or system whose failure to perform can be reasonably expected to cause the failure of the life support device or system, or to affect its safety or effectiveness.

Fairchild Semiconductor Corporation Americas
Customer Response Center
Tel: 1-888-522-5372

www.fairchildsemi.com

Fairchild Semiconductor Europe
Fax: +49 (0) 1 80-530 85 86
Email: europa.support@nsc.com
Deutsch Tel: +49 (0) 8 141-35-0
English Tel: +44 (0) 1 793-85-68-56
Italy Tel: +39 (0) 2 57 5631

Fairchild Semiconductor Hong Kong Ltd.
13th Floor, Straight Block,
Ocean Centre, 5 Canton Rd.
Tsimshatsui, Kowloon
Hong Kong
Tel: +852 2737-7200
Fax: +852 2314-0061

National Semiconductor Japan Ltd.
Tel: 81-3-5620-6175
Fax: 81-3-5620-6179