

## DM74LS02 Quad 2-Input NOR Gates

### General Description

This device contains four independent gates each of which performs the logic NOR function.

### Features

- Alternate Military/Aerospace device (54LS02) is available. Contact a Fairchild Semiconductor Sales Office/Distributor for specifications

### Connection Diagram

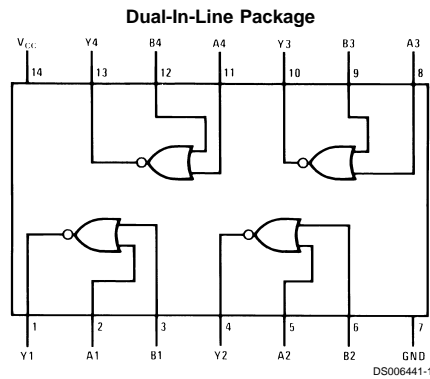

Order Number 54LS02DMQB, 54LS02FMQB, 54LS02LMQB, DM54LS02J, DM54LS02W,  
DM74LS02M or DM74LS02N  
See Package Number E20A, J14A, M14A, N14A or W14B

### Function Table

$$Y = \overline{A + B}$$

Inputs		Output
A	B	Y
L	L	H
L	H	L
H	L	L
H	H	L

H = High Logic Level  
L = Low Logic Level

## Absolute Maximum Ratings (Note 1)

Supply Voltage	7V
Input Voltage	7V
Operating Free Air Temperature Range	
DM54LS and 54LS	-55°C to +125°C
DM74LS	0°C to +70°C

Storage Temperature Range -65°C to +150°C

**Note 1:** The "Absolute Maximum Ratings" are those values beyond which the safety of the device cannot be guaranteed. The device should not be operated at these limits. The parametric values defined in the "Electrical Characteristics" table are not guaranteed at the absolute maximum ratings. The "Recommended Operating Conditions" table will define the conditions for actual device operation.

## Recommended Operating Conditions

Symbol	Parameter	DM54LS02			DM74LS02			Units
		Min	Nom	Max	Min	Nom	Max	
V <sub>CC</sub>	Supply Voltage	4.5	5	5.5	4.75	5	5.25	V
V <sub>IH</sub>	High Level Input Voltage	2			2			V
V <sub>IL</sub>	Low Level Input Voltage			0.7			0.8	V
I <sub>OH</sub>	High Level Output Current			-0.4			-0.4	mA
I <sub>OL</sub>	Low Level Output Current			4			8	mA
T <sub>A</sub>	Free Air Operating Temperature	-55		125	0		70	°C

## Electrical Characteristics

over recommended operating free air temperature range (unless otherwise noted)

Symbol	Parameter	Conditions	Min	Typ (Note 2)	Max	Units
V <sub>I</sub>	Input Clamp Voltage	V <sub>CC</sub> = Min, I <sub>I</sub> = -18 mA			-1.5	V
V <sub>OH</sub>	High Level Output Voltage	V <sub>CC</sub> = Min, I <sub>OH</sub> = Max, V <sub>IL</sub> = Max	DM54	2.5	3.4	V
			DM74	2.7	3.4	
V <sub>OL</sub>	Low Level Output Voltage	V <sub>CC</sub> = Min, I <sub>OL</sub> = Max, V <sub>IH</sub> = Min	DM54	0.25	0.4	V
			DM74	0.35	0.5	
		I <sub>OL</sub> = 4 mA, V <sub>CC</sub> = Min	DM74	0.25	0.4	
I <sub>I</sub>	Input Current @ Max Input Voltage	V <sub>CC</sub> = Max, V <sub>I</sub> = 7V			0.1	mA
I <sub>IH</sub>	High Level Input Current	V <sub>CC</sub> = Max, V <sub>I</sub> = 2.7V			20	µA
I <sub>IL</sub>	Low Level Input Current	V <sub>CC</sub> = Max, V <sub>I</sub> = 0.4V			-0.40	mA
I <sub>OS</sub>	Short Circuit Output Current	V <sub>CC</sub> = Max (Note 3)	DM54	-20	-100	mA
			DM74	-20	-100	
I <sub>CCH</sub>	Supply Current with Outputs High	V <sub>CC</sub> = Max		1.6	3.2	mA
I <sub>CCL</sub>	Supply Current with Outputs Low	V <sub>CC</sub> = Max		2.8	5.4	mA

## Switching Characteristics

at V<sub>CC</sub> = 5V and T<sub>A</sub> = 25°C (See Section 1 for Test Waveforms and Output Load)

Symbol	Parameter	R <sub>L</sub> = 2 kΩ				Units
		C <sub>L</sub> = 15 pF		C <sub>L</sub> = 50 pF		
		Min	Max	Min	Max	
t <sub>PLH</sub>	Propagation Delay Time Low to High Level Output		13		18	ns
t <sub>PHL</sub>	Propagation Delay Time High to Low Level Output		10		15	ns

**Note 2:** All typicals are at V<sub>CC</sub> = 5V, T<sub>A</sub> = 25°C.

**Note 3:** Not more than one output should be shorted at a time, and the duration should not exceed one second.



**Physical Dimensions** inches (millimeters) unless otherwise noted

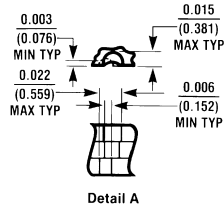
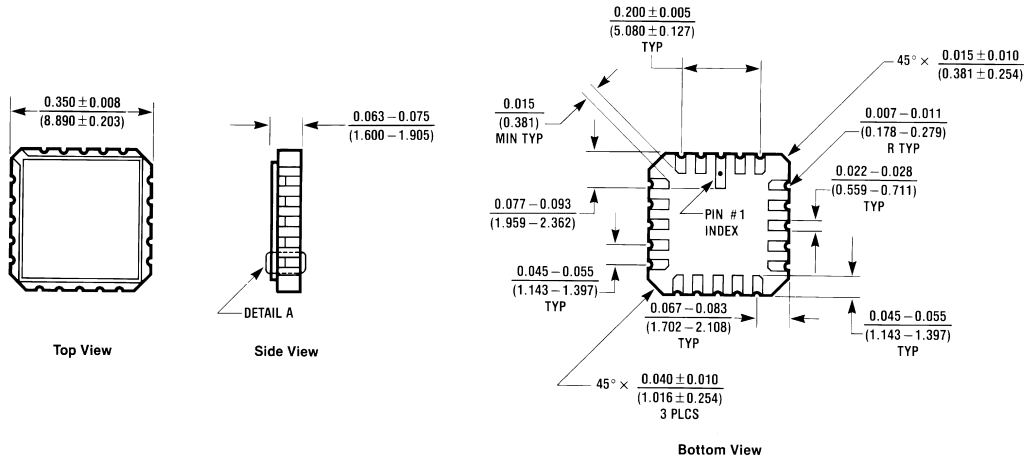

**Ceramic Leadless Chip Carrier Package (E)**  
**Order Number 54LS02LMQB**  
**Package Number E20A**

E20A (REV D)

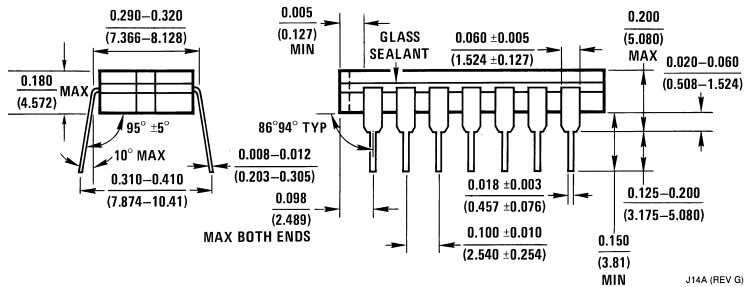
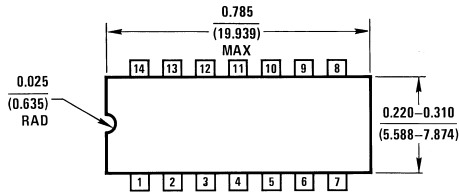

**14-Lead Ceramic Dual-In-Line Package (J)**  
**Order Number 54LS02DMQB or DM54LS02J**  
**Package Number J14A**

J14A (REV G)

**Physical Dimensions** inches (millimeters) unless otherwise noted (Continued)

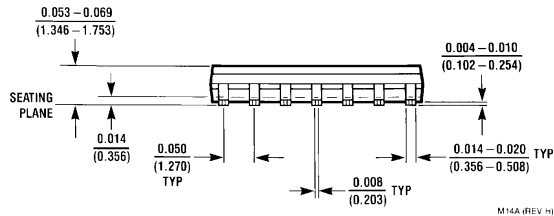
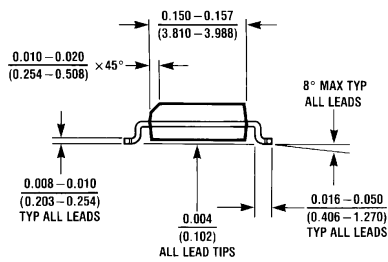
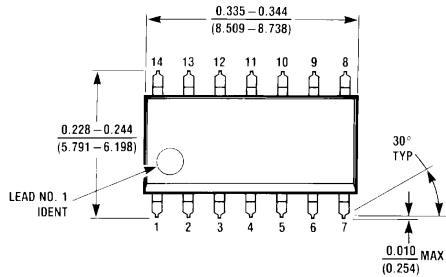

**14-Lead Small Outline Molded Package (M)**  
**Order Number DM74LS02M**  
**Package Number M14A**

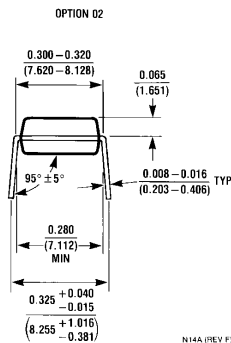
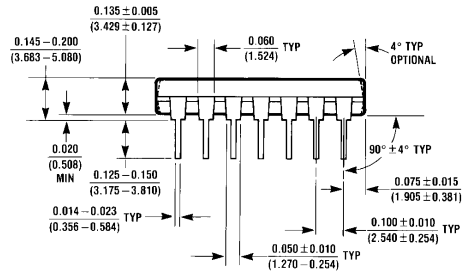
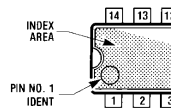
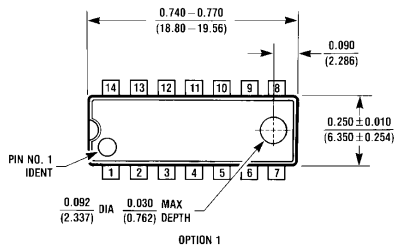

**14-Lead Molded Dual-In-Line Package (N)**  
**Order Number DM74LS02N**  
**Package Number N14A**

**Physical Dimensions** inches (millimeters) unless otherwise noted (Continued)

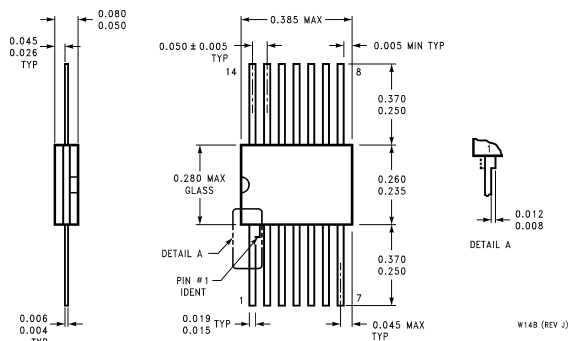

**14-Lead Ceramic Flat Package (W)**  
**Order Number 54LS02FMQB or DM54LS02W**  
**Package Number W14B**

**LIFE SUPPORT POLICY**

FAIRCHILD'S PRODUCTS ARE NOT AUTHORIZED FOR USE AS CRITICAL COMPONENTS IN LIFE SUPPORT DEVICES OR SYSTEMS WITHOUT THE EXPRESS WRITTEN APPROVAL OF THE PRESIDENT OF FAIRCHILD SEMICONDUCTOR CORPORATION. As used herein:

1. Life support devices or systems are devices or systems which, (a) are intended for surgical implant into the body, or (b) support or sustain life, and (c) whose failure to perform when properly used in accordance with instructions for use provided in the labeling, can be reasonably expected to result in a significant injury to the user.
2. A critical component in any component of a life support device or system whose failure to perform can be reasonably expected to cause the failure of the life support device or system, or to affect its safety or effectiveness.

**Fairchild Semiconductor Corporation Americas**  
 Customer Response Center  
 Tel: 1-888-522-5372

**Fairchild Semiconductor Europe**  
 Fax: +49 (0) 1 80-530 85 86  
 Email: europe.support@nsc.com  
 Deutsch Tel: +49 (0) 8 141-35-0  
 English Tel: +44 (0) 1 793-85-68-56  
 Italy Tel: +39 (0) 2 57 5631

**Fairchild Semiconductor Hong Kong Ltd.**  
 13th Floor, Straight Block,  
 Ocean Centre, 5 Canton Rd.  
 Tsimshatsui, Kowloon  
 Hong Kong  
 Tel: +862 2737-7200  
 Fax: +852 2314-0061

**National Semiconductor Japan Ltd.**  
 Tel: 81-3-5620-6175  
 Fax: 81-3-5620-6179

[www.fairchildsemi.com](http://www.fairchildsemi.com)