

## DM74LS74A Dual Positive-Edge-Triggered D Flip-Flops with Preset, Clear and Complementary Outputs

### General Description

This device contains two independent positive-edge-triggered D flip-flops with complementary outputs. The information on the D input is accepted by the flip-flops on the positive going edge of the clock pulse. The triggering occurs at a voltage level and is not directly related to the transition time of the rising edge of the clock. The data on the D input may be changed while the clock is low or high without affecting the outputs as long as the data setup and

hold times are not violated. A low logic level on the preset or clear inputs will set or reset the outputs regardless of the logic levels of the other inputs.

### Features

- Alternate military/aerospace device (54LS74) is available. Contact a Fairchild Semiconductor Sales Office/Distributor for specifications.

### Connection Diagram

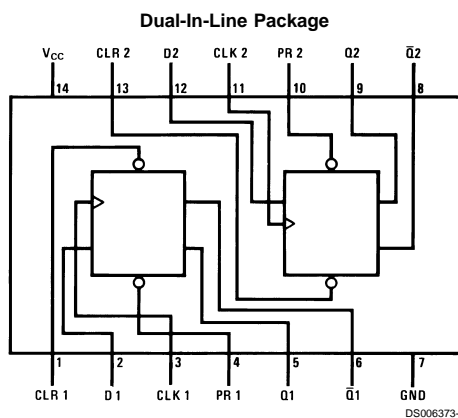

Order Number 54LS74DMQB, 54LS74FMQB, 54LS74LMQB,  
DM54LS74AJ, DM54LS74AW, DM74LS74AM or DM74LS74AN  
See Package Number E20A, J14A, M14A, N14A or W14B

### Function Table

Inputs				Outputs	
PR	CLR	CLK	D	Q	$\bar{Q}$
L	H	X	X	H	L
H	L	X	X	L	H
L	L	X	X	H (Note 1)	H (Note 1)
H	H	↑	H	H	L
H	H	↑	L	L	H
H	H	L	X	Q <sub>0</sub>	$\bar{Q}$ <sub>0</sub>

H = High Logic Level  
X = Either Low or High Logic Level  
L = Low Logic Level  
↑ = Positive-going Transition

Q<sub>0</sub> = The output logic level of Q before the indicated input conditions were established.

**Note 1:** This configuration is nonstable; that is, it will not persist when either the preset and/or clear inputs return to their inactive (high) level.

## Absolute Maximum Ratings (Note 2)

Supply Voltage	7V	DM54LS and 54LS	-55°C to +125°C
Input Voltage	7V	DM74LS	0°C to +70°C
Operating Free Air Temperature Range		Storage Temperature Range	-65°C to +150°C

## Recommended Operating Conditions

Symbol	Parameter	DM54LS74A			DM74LS74A			Units
		Min	Nom	Max	Min	Nom	Max	
V <sub>CC</sub>	Supply Voltage	4.5	5	5.5	4.75	5	5.25	V
V <sub>IH</sub>	High Level Input Voltage	2			2			V
V <sub>IL</sub>	Low Level Input Voltage			0.7			0.8	V
I <sub>OH</sub>	High Level Output Current			-0.4			-0.4	mA
I <sub>OL</sub>	Low Level Output Current			4			8	mA
f <sub>CLK</sub>	Clock Frequency (Note 4)	0		25	0		25	MHz
f <sub>CLK</sub>	Clock Frequency (Note 5)	0		20	0		20	MHz
t <sub>w</sub>	Pulse Width (Note 4)	Clock High	18		18			ns
		Preset Low	15		15			
		Clear Low	15		15			
t <sub>w</sub>	Pulse Width (Note 5)	Clock High	25		25			ns
		Preset Low	20		20			
		Clear Low	20		20			
t <sub>SU</sub>	Setup Time (Notes 3, 4)	20↑			20↑			ns
t <sub>SU</sub>	Setup Time (Notes 3, 5)	25↑			25↑			ns
t <sub>H</sub>	Hold Time (Notes 3, 6)	0↑			0↑			ns
T <sub>A</sub>	Free Air Operating Temperature	-55		125	0		70	°C

**Note 2:** The "Absolute Maximum Ratings" are those values beyond which the safety of the device cannot be guaranteed. The device should not be operated at these limits. The parametric values defined in the "Electrical Characteristics" table are not guaranteed at the absolute maximum ratings. The "Recommended Operating Conditions" table will define the conditions for actual device operation.

**Note 3:** The symbol (↑) indicates the rising edge of the clock pulse is used for reference.

**Note 4:** C<sub>L</sub> = 15 pF, R<sub>L</sub> = 2 kΩ, T<sub>A</sub> = 25°C, and V<sub>CC</sub> = 5V.

**Note 5:** C<sub>L</sub> = 50 pF, R<sub>L</sub> = 2 kΩ, T<sub>A</sub> = 25°C, and V<sub>CC</sub> = 5V.

**Note 6:** T<sub>A</sub> = 25°C and V<sub>CC</sub> = 5V.

## Electrical Characteristics

over recommended operating free air temperature range (unless otherwise noted)

Symbol	Parameter	Conditions	Min	Typ (Note 7)	Max	Units
V <sub>I</sub>	Input Clamp Voltage	V <sub>CC</sub> = Min, I <sub>I</sub> = -18 mA			-1.5	V
V <sub>OH</sub>	High Level Output Voltage	V <sub>CC</sub> = Min, I <sub>OH</sub> = Max	DM54	2.5	3.4	V
		V <sub>IL</sub> = Max, V <sub>IH</sub> = Min	DM74	2.7	3.4	
V <sub>OL</sub>	Low Level Output Voltage	V <sub>CC</sub> = Min, I <sub>OL</sub> = Max	DM54		0.25	V
		V <sub>IL</sub> = Max, V <sub>IH</sub> = Min	DM74		0.35	
		I <sub>OL</sub> = 4 mA, V <sub>CC</sub> = Min	DM74		0.25	
I <sub>I</sub>	Input Current @Max Input Voltage	V <sub>CC</sub> = Max V <sub>I</sub> = 7V	Data		0.1	mA
			Clock		0.1	
			Preset		0.2	
			Clear		0.2	
I <sub>IH</sub>	High Level Input Current	V <sub>CC</sub> = Max V <sub>I</sub> = 2.7V	Data		20	μA
			Clock		20	
			Clear		40	
			Preset		40	

## Electrical Characteristics (Continued)

over recommended operating free air temperature range (unless otherwise noted)

Symbol	Parameter	Conditions	Min	Typ (Note 7)	Max	Units
$I_{IL}$	Low Level Input Current	$V_{CC} = \text{Max}$ $V_I = 0.4V$	Data		-0.4	mA
			Clock		-0.4	
			Preset		-0.8	
			Clear		-0.8	
$I_{OS}$	Short Circuit Output Current	$V_{CC} = \text{Max}$ (Note 8)	DM54	-20	-100	mA
			DM74	-20	-100	
$I_{CC}$	Supply Current	$V_{CC} = \text{Max}$ (Note 9)		4	8	mA

**Note 7:** All typicals are at  $V_{CC} = 5V$ ,  $T_A = 25^\circ C$ .

**Note 8:** Not more than one output should be shorted at a time, and the duration should not exceed one second. For devices, with feedback from the outputs, where shorting the outputs to ground may cause the outputs to change logic state an equivalent test may be performed where  $V_O = 2.25V$  and  $2.125V$  for DM54 and DM74 series, respectively, with the minimum and maximum limits reduced by one half from their stated values. This is very useful when using automatic test equipment.

**Note 9:** With all outputs open,  $I_{CC}$  is measured with CLOCK grounded after setting the Q and  $\bar{Q}$  outputs high in turn.

## Switching Characteristics

at  $V_{CC} = 5V$  and  $T_A = 25^\circ C$

Symbol	Parameter	From (Input) To (Output)	$R_L = 2\text{ k}\Omega$				Units
			$C_L = 15\text{ pF}$		$C_L = 50\text{ pF}$		
			Min	Max	Min	Max	
$f_{MAX}$	Maximum Clock Frequency		25		20		MHz
$t_{PLH}$	Propagation Delay Time Low to High Level Output	Clock to Q or $\bar{Q}$		25		35	ns
$t_{PHL}$	Propagation Delay Time High to Low Level Output	Clock to Q or $\bar{Q}$		30		35	ns
$t_{PLH}$	Propagation Delay Time Low to High Level Output	Preset to Q		25		35	ns
$t_{PHL}$	Propagation Delay Time High to Low Level Output	Preset to $\bar{Q}$		30		35	ns
$t_{PLH}$	Propagation Delay Time Low to High Level Output	Clear to $\bar{Q}$		25		35	ns
$t_{PHL}$	Propagation Delay Time High to Low Level Output	Clear to Q		30		35	ns

**Physical Dimensions** inches (millimeters) unless otherwise noted

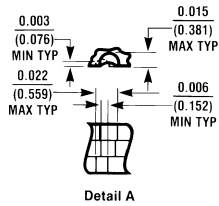
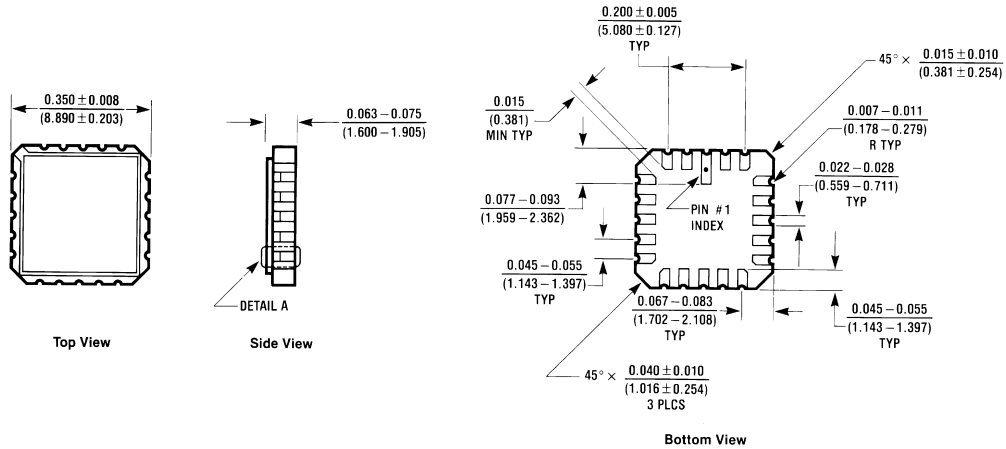

**Ceramic Leadless Chip Carrier Package (E)**  
 Order Number 54LS74LMQB  
 Package Number E20A

E20A (REV D)

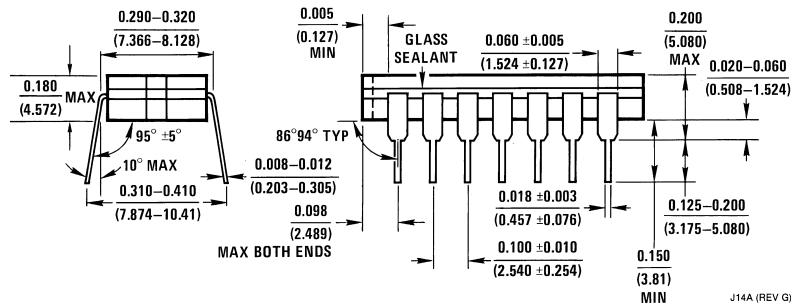
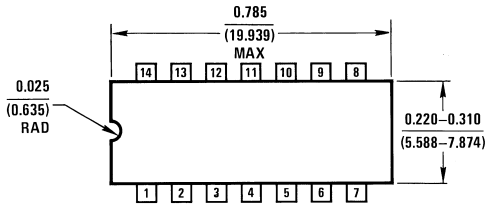

J14A (REV G)

**14-Lead Ceramic Dual-In-Line Package (J)**  
 Order Number 54LS74DMQB or DM54LS74AJ  
 Package Number J14A

**Physical Dimensions** inches (millimeters) unless otherwise noted (Continued)

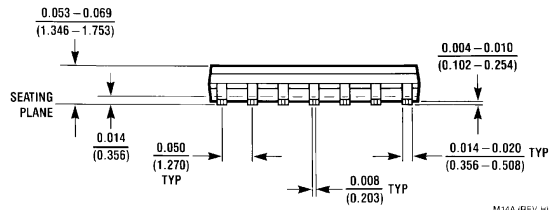
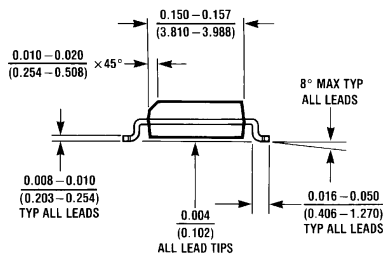
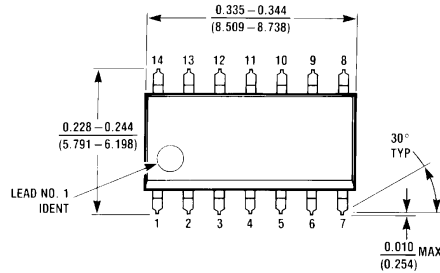

M14A (REV. H)

**14-Lead Small Outline Molded Package (M)**  
**Order Number DM74LS74AM**  
**Package Number M14A**

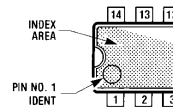
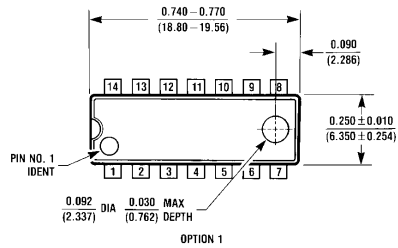

OPTION 02

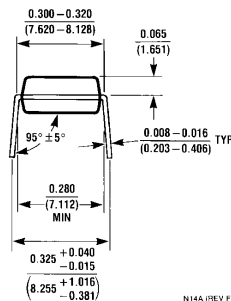
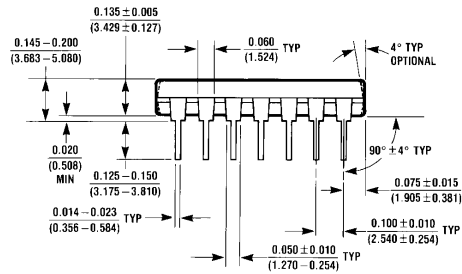

N14A (REV. F)

**14-Lead Molded Dual-In-Line Package (N)**  
**Order Number DM74LS74AN**  
**Package Number N14A**

**DM74LS74A Dual Positive-Edge-Triggered D Flip-Flops with Preset, Clear and Complementary Outputs**

**Physical Dimensions** inches (millimeters) unless otherwise noted (Continued)

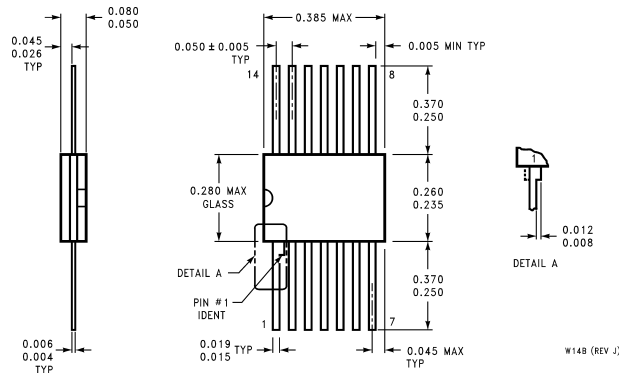

**14-Lead Ceramic Flat Package (W)**  
**Order Number 54LS74FMQB or DM54LS74AW**  
**Package Number W14B**

**LIFE SUPPORT POLICY**

FAIRCHILD'S PRODUCTS ARE NOT AUTHORIZED FOR USE AS CRITICAL COMPONENTS IN LIFE SUPPORT DEVICES OR SYSTEMS WITHOUT THE EXPRESS WRITTEN APPROVAL OF THE PRESIDENT OF FAIRCHILD SEMICONDUCTOR CORPORATION. As used herein:

1. Life support devices or systems are devices or systems which, (a) are intended for surgical implant into the body, or (b) support or sustain life, and (c) whose failure to perform when properly used in accordance with instructions for use provided in the labeling, can be reasonably expected to result in a significant injury to the user.
2. A critical component in any component of a life support device or system whose failure to perform can be reasonably expected to cause the failure of the life support device or system, or to affect its safety or effectiveness.

**Fairchild Semiconductor Corporation Americas**  
 Customer Response Center  
 Tel: 1-888-522-5372

**Fairchild Semiconductor Europe**  
 Fax: +49 (0) 1 80-530 85 86  
 Email: europe.support@nsc.com  
 Deutsch Tel: +49 (0) 8 141-35-0  
 English Tel: +44 (0) 1 793-85-68-56  
 Italy Tel: +39 (0) 2 57 5631

**Fairchild Semiconductor Hong Kong Ltd.**  
 13th Floor, Straight Block,  
 Ocean Centre, 5 Canton Rd.  
 Tsimshatsui, Kowloon  
 Hong Kong  
 Tel: +852 2737-7200  
 Fax: +852 2314-0061

**National Semiconductor Japan Ltd.**  
 Tel: 81-3-5620-6175  
 Fax: 81-3-5620-6179

[www.fairchildsemi.com](http://www.fairchildsemi.com)