

FS30KMJ-06

HIGH-SPEED SWITCHING USE

FS30KMJ-06

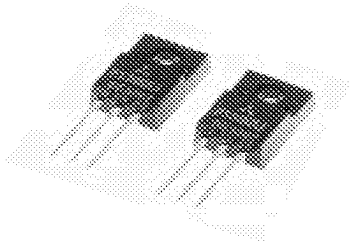

- ∨ 4V DRIVE
- ∨ V_{DSS} 60V
- ∨ r_{DS (ON)} (MAX) 30mΩ
- ∨ I_D 30A
- ∨ Integrated Fast Recovery Diode (TYP.) 60ns
- ∨ V_{iso} 2000V

OUTLINE DRAWING

Dimensions in mm

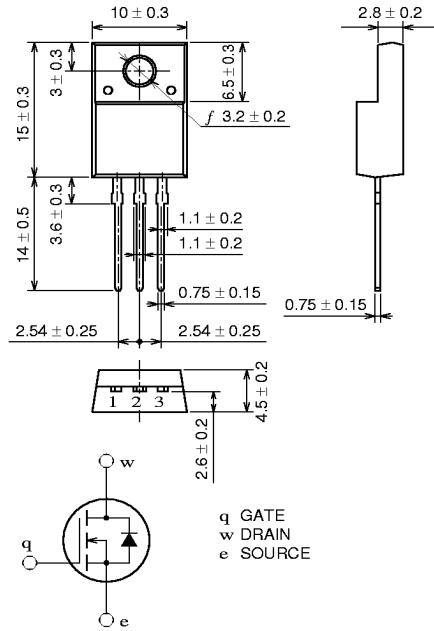

TO-220FN

APPLICATION

Motor control, Lamp control, Solenoid control
DC-DC converter, etc.

MAXIMUM RATINGS (T_c = 25°C)

Symbol	Parameter	Conditions	Ratings	Unit
V _{DSS}	Drain-source voltage	V _{GS} = 0V	60	V
V _{GSS}	Gate-source voltage	V _{DS} = 0V	±20	V
I _D	Drain current		30	A
I _{DM}	Drain current (Pulsed)		120	A
I _{DA}	Avalanche drain current (Pulsed)	L = 100μH	30	A
I _S	Source current		30	A
I _{SM}	Source current (Pulsed)		120	A
P _D	Maximum power dissipation		25	W
T _{ch}	Channel temperature		-55 ~ +150	°C
T _{stg}	Storage temperature		-55 ~ +150	°C
V _{iso}	Isolation voltage	AC for 1 minute, Terminal to case	2000	V
—	Weight	Typical value	2.0	g

Feb.1999



FS30KMJ-06

HIGH-SPEED SWITCHING USE

ELECTRICAL CHARACTERISTICS (Tch = 25°C)

Symbol	Parameter	Test conditions	Limits			Unit
			Min.	Typ.	Max.	
V(BR)DSS	Drain-source breakdown voltage	ID = 1mA, VGS = 0V	60	—	—	V
IGSS	Gate-source leakage current	VGS = ±20V, VDS = 0V	—	—	±0.1	μA
IDSS	Drain-source leakage current	VDS = 60V, VGS = 0V	—	—	0.1	mA
VGS(th)	Gate-source threshold voltage	ID = 1mA, VDS = 10V	1.0	1.5	2.0	V
rDS(ON)	Drain-source on-state resistance	ID = 15A, VGS = 10V	—	25	30	mΩ
rDS(ON)	Drain-source on-state resistance	ID = 15A, VGS = 4V	—	31	38	mΩ
VDS(ON)	Drain-source on-state voltage	ID = 15A, VGS = 10V	—	0.38	0.45	V
yfs	Forward transfer admittance	ID = 15A, VDS = 10V	—	28	—	S
Ciss	Input capacitance	VDS = 10V, VGS = 0V, f = 1MHz	—	1800	—	pF
Coss	Output capacitance		—	340	—	pF
Crss	Reverse transfer capacitance		—	180	—	pF
td(on)	Turn-on delay time	VDD = 30V, ID = 15A, VGS = 10V, RGEN = RGS = 50Ω	—	17	—	ns
tr	Rise time		—	46	—	ns
td(off)	Turn-off delay time		—	120	—	ns
tf	Fall time		—	95	—	ns
VSD	Source-drain voltage		IS = 15A, VGS = 0V	—	1.0	1.5
Rth(ch-c)	Thermal resistance	Channel to case	—	—	5.00	°C/W
trr	Reverse recovery time	IS = 30A, dis/dt = -100A/μs	—	60	—	ns

PERFORMANCE CURVES

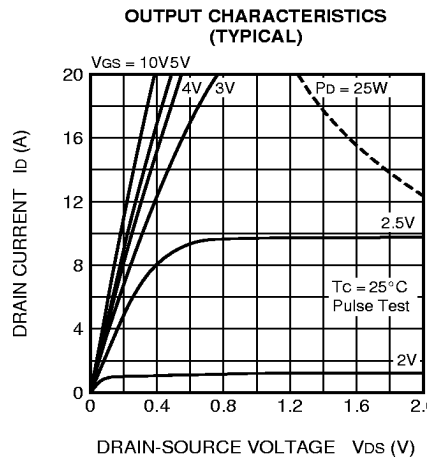
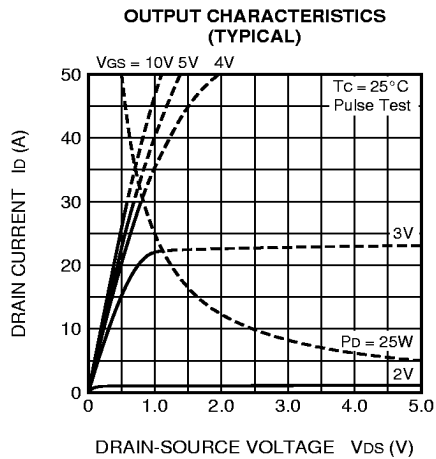
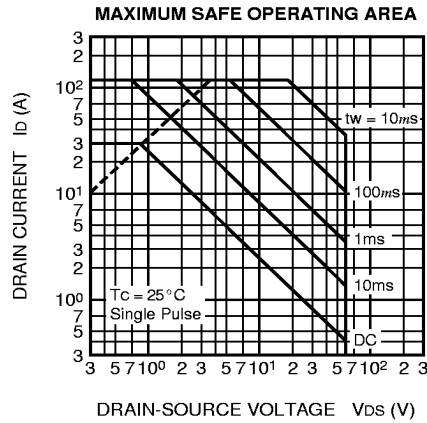
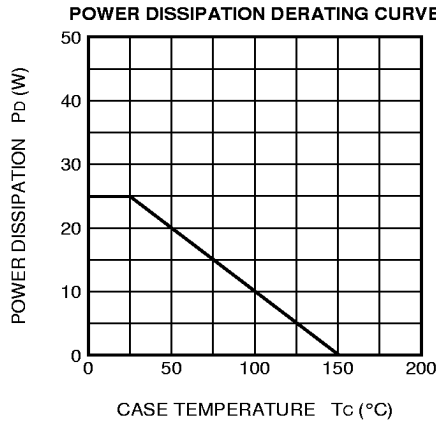

Feb.1999



FS30KMJ-06

HIGH-SPEED SWITCHING USE

ON-STATE VOLTAGE VS. GATE-SOURCE VOLTAGE (TYPICAL)

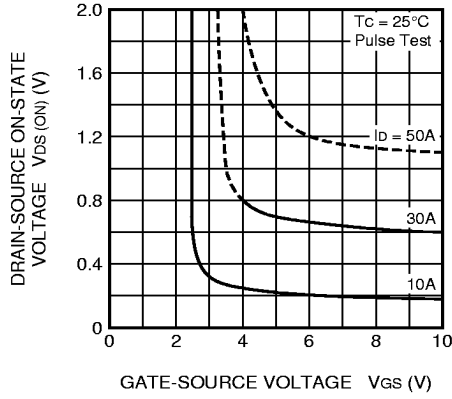

ON-STATE RESISTANCE VS. DRAIN CURRENT (TYPICAL)

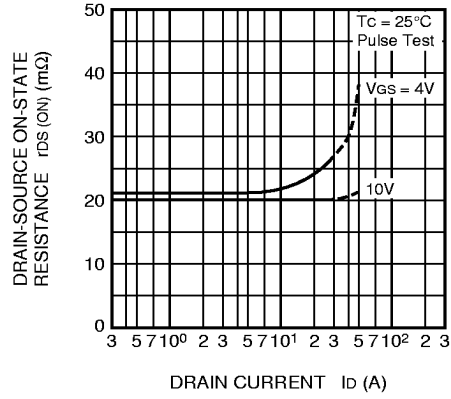

TRANSFER CHARACTERISTICS (TYPICAL)

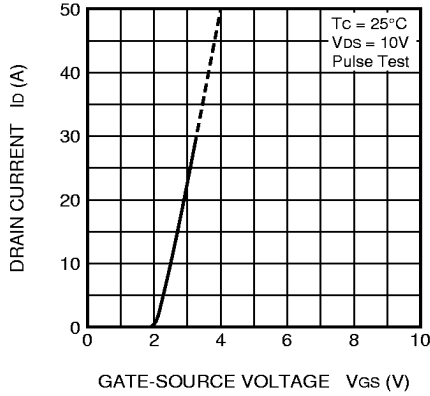

FORWARD TRANSFER ADMITTANCE VS. DRAIN CURRENT (TYPICAL)

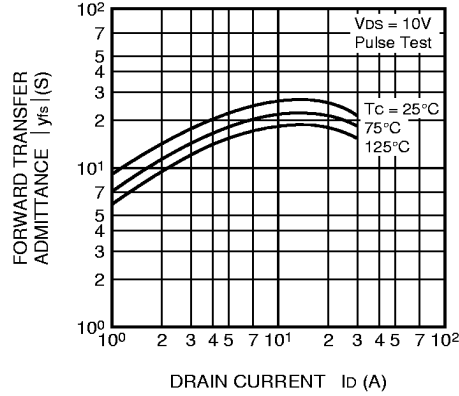

CAPACITANCE VS. DRAIN-SOURCE VOLTAGE (TYPICAL)

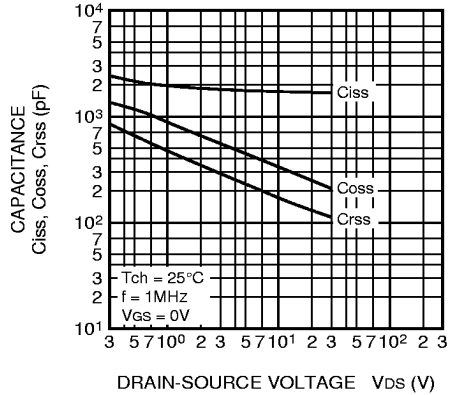

SWITCHING CHARACTERISTICS (TYPICAL)

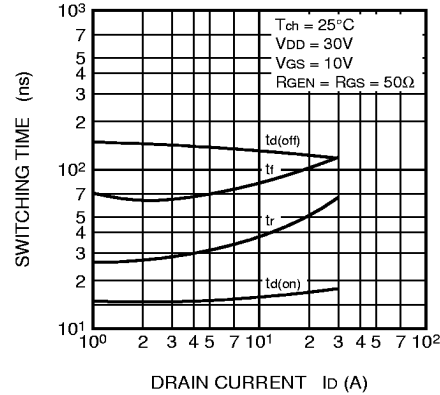

Feb.1999



FS30KMJ-06

HIGH-SPEED SWITCHING USE

