HA12203NT/HA12204NT

Audio Signal Processor for Cassette Deck
(Dolby B-type NR with Recording System)

HITACHI

ADE-207-222B

Target Specification
3rd Edition
Jun. 1999

Description

HA12203NT is silicon monolithic bipolar IC providing Dolby noise reduction system*¹, music sensor system, REC equalizer system and each electronic control switch in one chip.

Note: 1. Dolby is a trademark of Dolby Laboratories Licensing Corporation. A license from Dolby Laboratories Licensing Corporation is required for the use of this IC.

Functions

- Dolby B - NR*² × 2 channel
- REC equalizer × 2 channel
- Music sensor × 1 channel
- Pass amp. × 2 channel
- Each electronic control switch to change REC equalizer, bias, etc.

Note: 2. HA12204NT is not built-in Dolby noise reduction system.

Features

- REC equalizer is very small number of external parts and have 6 types of frequency characteristics built-in.*³
- 2 types of input for PB, 1 type of input for REC.
- 70μ - PB equalizer changing system built-in.
- Dolby NR with dubbing double cassette decks.
Unprocessed signal output available from recording out terminals during PB mode.
- Provide stable music sensor system, available to design music sensing time and level.
- Controllable from direct micro-computer output.
- Bias oscillator control switch built-in.
- NR ON / OFF and REC / PB fully electronic control switching built-in.
- Normal-speed / high-speed, Normal / Crom / Metal*³ and PB equalizer fully electronic control switching built-in.
- Available to reduce substrate-area because of high integration and small external parts.

HA12203NT/HA12204NT

Note: 3. HA12204NT have 4 types of frequency characteristics.

Ordering Information

Standard Level

Product	Package	PB-OUT	REC-OUT	Dolby	Operating Voltage Range		
		Level	Level	Level	V _{CC} (V)	V _{EE} (V)	Note
HA12203NT	DP-42S	580mVrms	300mVrms	300mVrms	+6.0 to +7.5	-7.5 to -6.0	V _{CC} + V _{EE} < 1.0V
HA12204NT				—			

Function

Product	Dolby B-NR	REC-EQ	Music Sensor	Pass Amp.	REC / PB	Selection
HA12203NT	○	○	○	○	○	○
HA12204NT		○	○	○	○	○

Note: Depending on the employed REC / PB head and test tape characteristics, there is a rare case that the REC-EQ characteristics of this LSI can not be matched to the required characteristics because of built-in resistors which determined the REC-EQ parameters in this case, please inquire the responsible agent because the adjustment built-in resistor is necessary.

Pin Description, Equivalent Circuit

($V_{CC} = \pm 7\text{ V}$, $T_a = 25^\circ\text{C}$, No Signal, The value in the show typical value.)

Pin No.	Terminal Name	Note	Equivalent Circuit	Pin Description
2	AIN (R)	$V = \text{GND}$		PB A Deck input
41	AIN (L)			
4	BIN (R)	$V = \text{GND}$		PB B Deck input
39	BIN (L)			
6	RIN (R)	$V = \text{GND}$		REC input
37	RIN (L)			
10	EQIN (R)	$V = \text{GND}$		REC equalizer input
33	EQIN (L)			
7	DET (R)	$V = V_{EE} + 2.7\text{V}$		Time constant pin for Dolby-NR
36	DET (L)			
5	BIAS1	$V = V_{EE} + 0.6\text{V}$		Dolby bias current input
38	BIAS2	$V = V_{EE} + 1.3\text{V}$		REC equalizer bias current input

HA12203NT/HA12204NT

Pin No.	Terminal Name	Note	Equivalent Circuit	Pin Description
8	PBOUT (R)	$V = GND$		PB output
35	PBOUT (L)			
9	RECOUT (R)	$V = GND$		REC output
34	RECOUT (L)			
11	EQOUT (R)	$V = GND$		Equalizer output
32	EQOUT (L)			
28	MAOUT	$V = GND$		MS Amp output
3	ABO (R)	$V = GND$		Time constant pin for PB equalizer
40	ABO (L)	$V = GND$		
23	BIAS (M)	$V = V_{CC} - 0.7V$		REC bias current output
24	BIAS (C)			
25	BIAS (N)			
22	V_{CC}	$V = V_{CC}$		Power supply
42	GND	$V = 0V$		GND pin
1	V_{EE}	$V = V_{EE}$		Negative power supply
5, 7, 18, 23, 30, 31, 36	NC	No connection only HA12204		No connection

Pin No.	Terminal Name	Note	Equivalent Circuit	Pin Description
12	A / B	$I = 50\mu\text{A}$		Mode control input
13	A120 / 70			
14	NORM / HIGH			
15	B NORM / CROM / METAL			
16	BIAS ON / OFF			
17	RM ON / OFF			
18	NR ON / OFF			
20	LM ON / OFF			
19	REC / PB / PASS			Mode control input
21	MSOUT	$I = 0\mu\text{A}$		MS output (to MPU)*1
30	GPCAL	$V = \text{GND}$		GP gain Calibration terminal
31	RECCAL	$V = \text{GND}$		REC gain calibration terminal

HA12203NT/HA12204NT

Pin No.	Terminal Name	Note	Equivalent Circuit	Pin Description
26	MSDET	$I = 0\mu\text{A}$		Time constant pin for MS
27	MSIN	$V = \text{GND}$		MS input *1)
29	MAI	$V = \text{GND}$		MS Amp input

Note: 1. "MS" means Music Sensor.

Block Diagram

HA12203NT

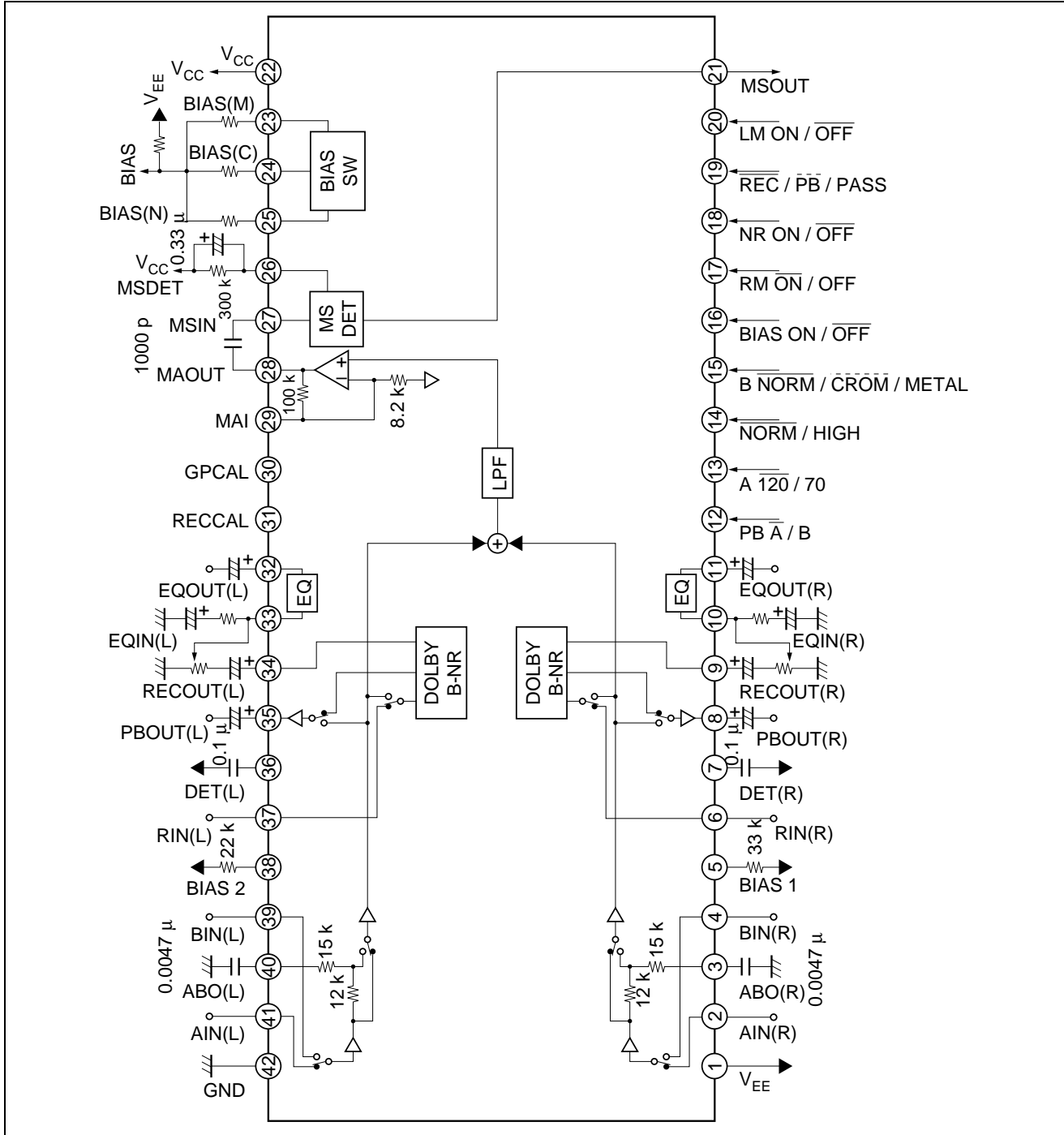

HA12203NT/HA12204NT

HA12204NT

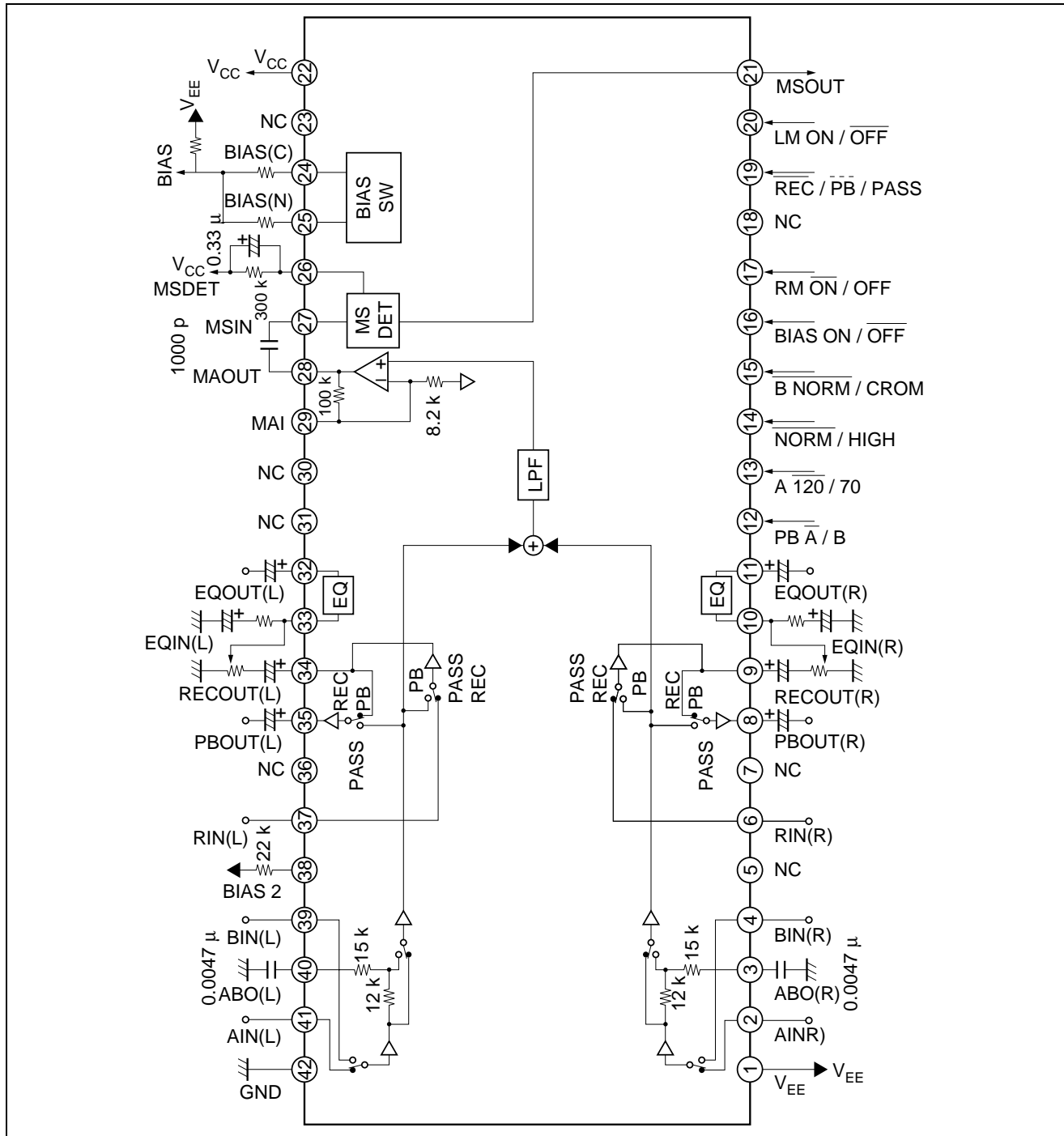

HA12203NT Parallel-Data Format

Pin No.	Pin Name	Lo	Mid	Hi	MODE "Pin Open"
12	PB \bar{A} / B	Ain *1	—	Bin *1	Lo
13	A $\bar{120}$ / 70	*1	—	*1	Lo
17	RM \bar{ON} / OFF	REC MUTE ON	—	REC MUTE OFF	Lo
16	BIAS ON / \bar{OFF}	BIAS OFF	—	BIAS ON	Lo
18	NR ON / \bar{OFF} *2	NR OFF	—	NR ON	Lo
19	\bar{REC} / PB / PASS	REC MODE	PB MODE	REC MODE PASS	Mid
20	LM ON / \bar{OFF}	LINE MUTE OFF	—	LINE MUTE ON	Lo
14	\bar{NORM} / HIGH	Normal speed	—	High speed	Lo
15	B \bar{NORM} / CROM / METAL	REC EQ Normal *1 Bias Normal	REC EQ CROM *1 Bias CROM	REC EQ METAL *1 Bias METAL *2	Lo

Note: 1. PB EQ logic

A $\bar{120}$ / 70	B \bar{NORM} / CROM / METAL	PB	
		Lo	Hi
Lo	Lo	FLAT	FLAT
Lo	Hi or Mid	FLAT	70 μ
Hi	Lo	70 μ	FLAT
Hi	Hi or Mid	70 μ	70 μ

Note: 2. HA12203NT only

Functional Description
Power Supply Range

HA12203NT / 204NT are designed to operate on split supply.

Table 1 Supply Voltage

Product	V _{CC}	V _{EE}	Note
HA12203NT	+6.0 to +7.5 V	-7.5 to -6.0 V	V _{CC} + V _{EE} < 1.0 V
HA12204NT			

Note: The lower limit of supply voltage depends on the line output reference level.
The minimum value of the overload margin is specified as 12dB by Dolby Laboratories.

HA12203NT/HA12204NT

Reference Voltage

The reference voltage are provided for the left channel and the right channel separately. The block diagram is shown as figure 1.

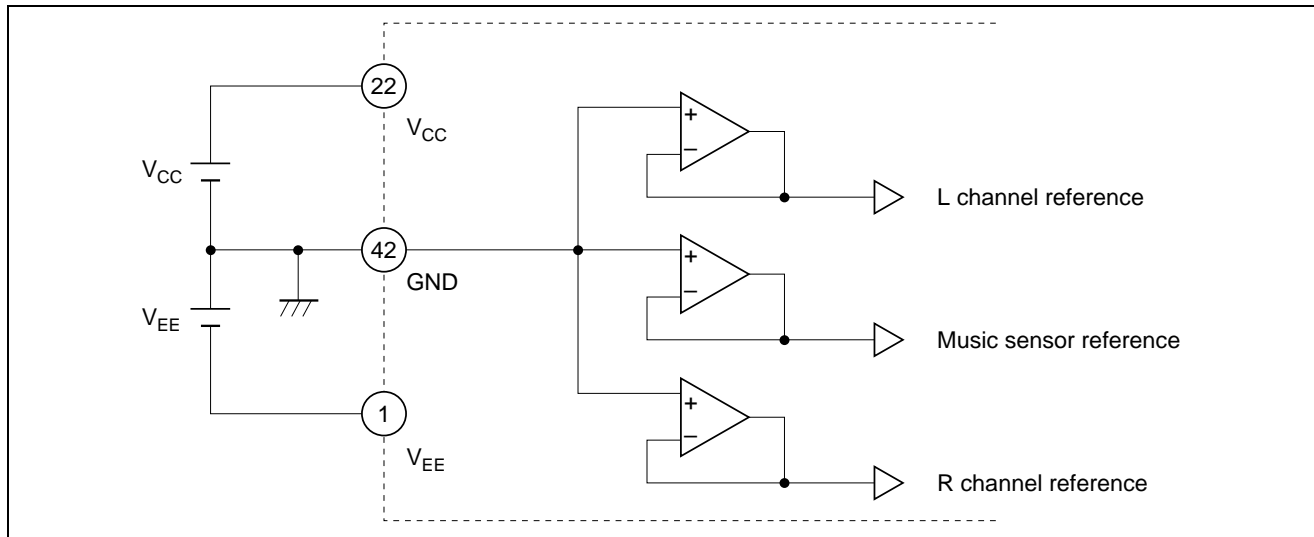

Figure 1 Reference Voltage

Operating Mode Control

HA12203NT / 204NT provide fully electronic switching circuits. And each operating mode control is controlled by parallel data (DC voltage).

Table 2 Control Voltage

Pin No.	Lo	Mid	Hi	Unit	Test Condition
12, 13, 14, 16, 17, 18, 20	-0.2 to 1.0	—	4.0 to V_{CC}	V	
15, 19	-0.2 to 1.0	2.0 to 3.0	4.0 to V_{CC}	V	

Notes: 1. Each pins are on pulled down with 100 k Ω internal resistor.

Therefore, it will be low-level when each pins are open.

But 19 pin are mid-level when it is open.

2. Over shoot level and under shoot level of input signal must be the standardized (High: V_{CC} , Low: -0.2V).

3. For reduction of pop noise, connect 1 μ F to 22 μ F capacitor with mode control pins.

But it is impossible to reduce completely in regard to Line mute, therefore, use external mute at the same time.

Input Block Diagram and Level Diagram

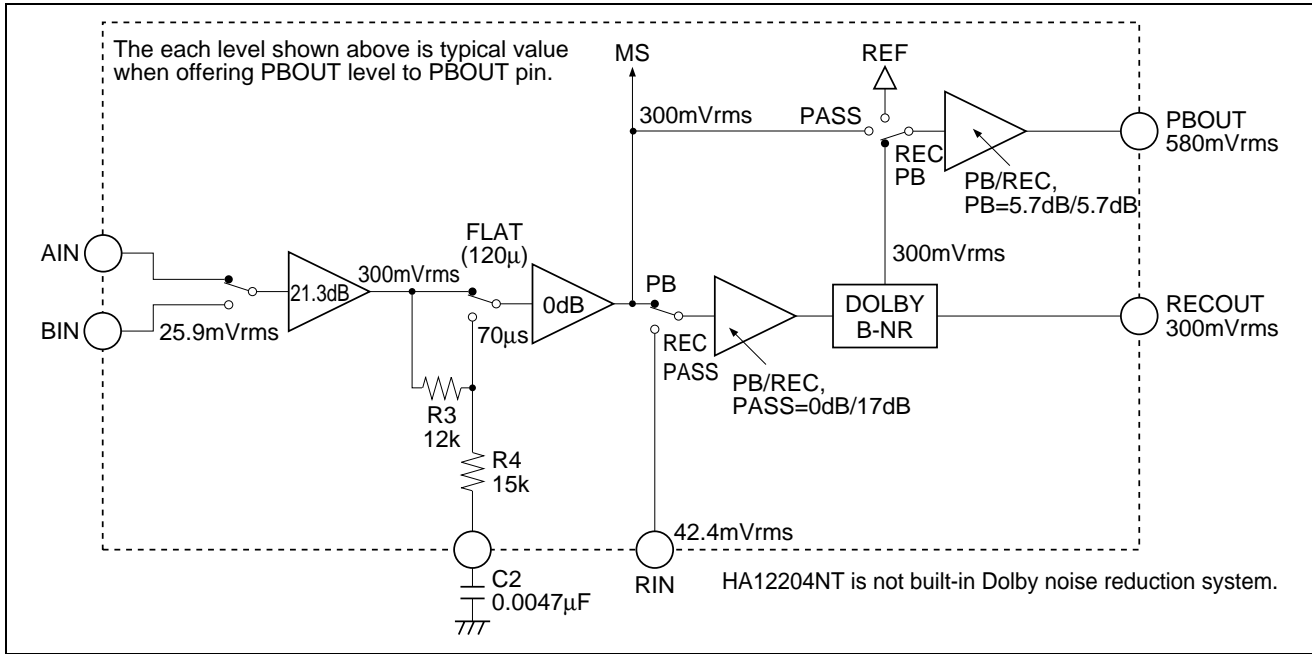

Figure 2 Input Block Diagram

PB Equalizer

By switching logical input level of 13 pin (for Ain) and 15 pin (for Bin), you can equalize corresponding to tape position at play back mode.

With the capacity C2 capacitance that we showed for figure 2 70 μs by the way figure seem to 3 they are decided.

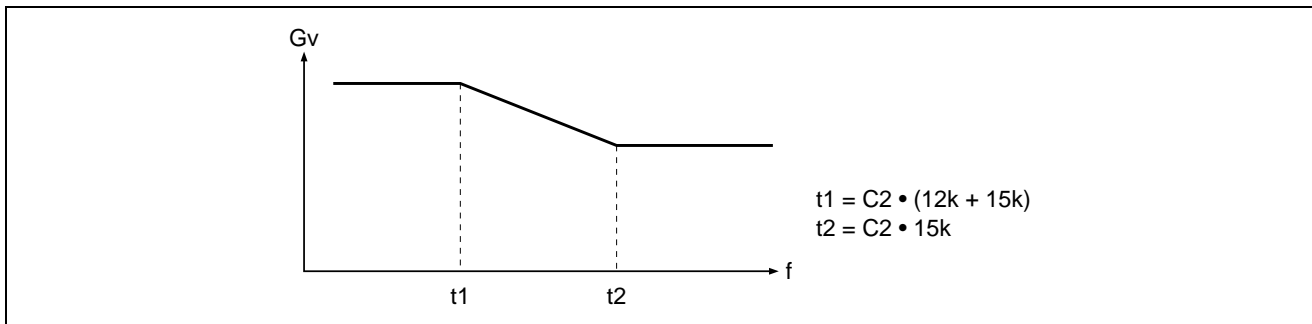

Figure 3 Frequency Characteristic of PB Equalizer

The Sensitivity Adjustment of Music Sensor

Adjusting MS Amp gain by external resistor, the sensitivity of music sensor can set up.

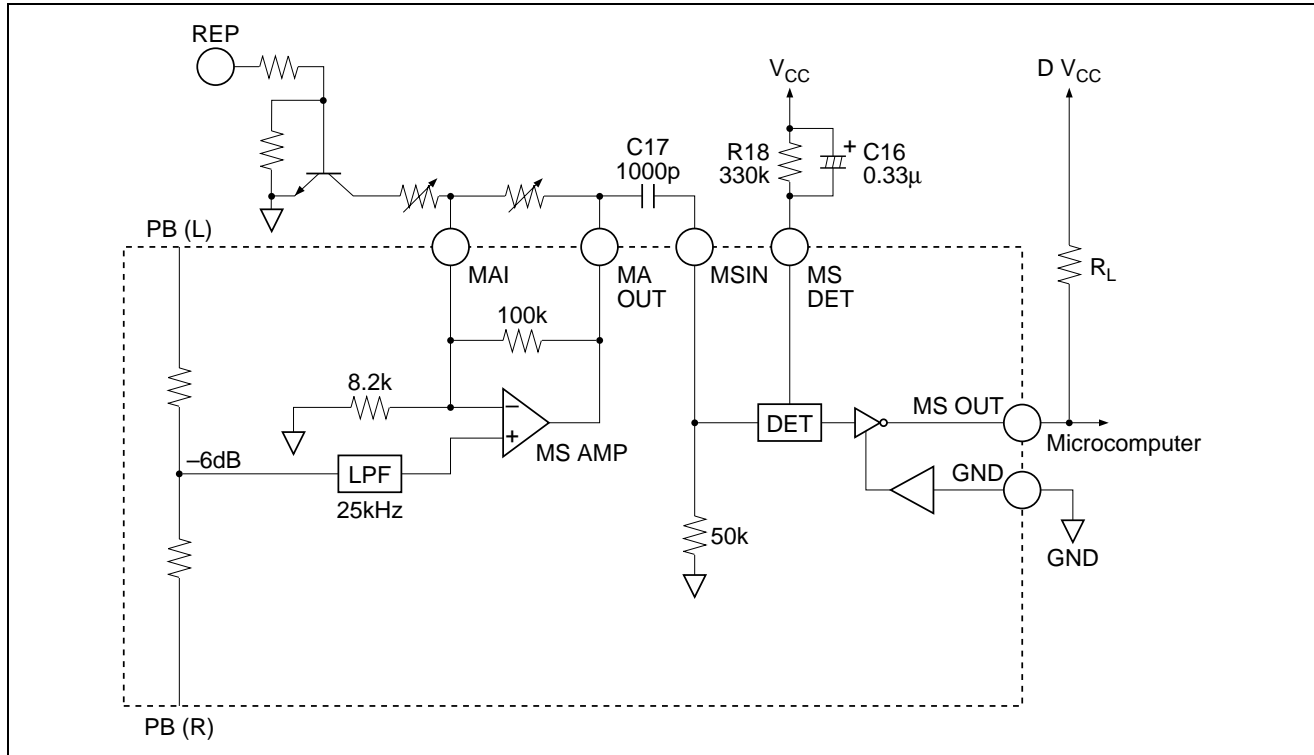

Figure 4 Music Sensor Block Diagram

The Sensitivity of Music Sensor

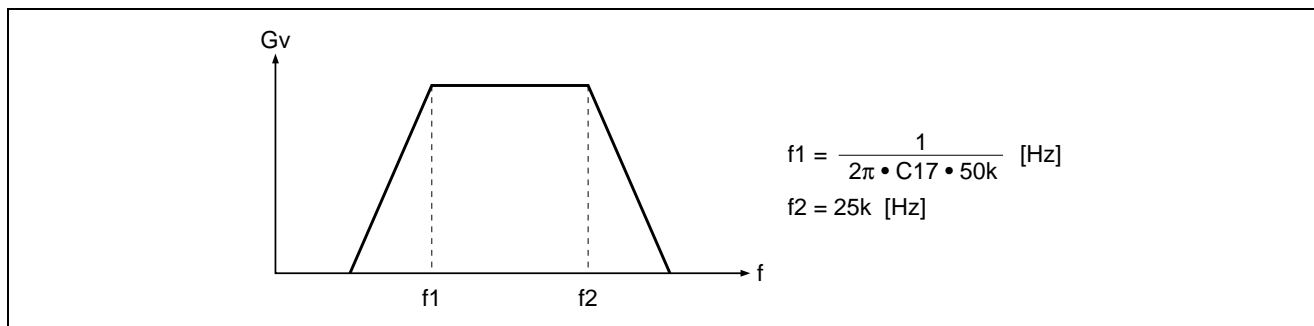

Figure 5 Frequency Characteristic of MSIN

Occasion of the external component of figure 4, f1 is 3.18 kHz.

A standard level of MS input pin 25.9 mVrms, therefore, the sensitivity of music sensor (S) can request it , by lower formulas.

$$\begin{aligned}
 A &= \text{MS Amp Gain} \\
 B &= \text{PB input Gain} \times (1/2)^{*1} \\
 C &= \text{Sensed voltage} \\
 20\log(A \times B) &= D \text{ [dB]} \\
 C &= 130 \text{ [mVrms]} \\
 \text{PB input Gain} &= 21.3 \text{ [dB]}
 \end{aligned}$$

$$S = 20\log \frac{C}{25.9 \cdot A \cdot B} \text{ [dB]}$$

$$S = 14 \text{ D [dB]}$$

Notes: 1. Case of one-sided channel input

- Time constant of detection

Figure 6(1) generally shows that detection time is in proportion to value of capacitor C16.

But, with Attack ^{*2} and Recovery ^{*3} the detection time differs exceptionally.

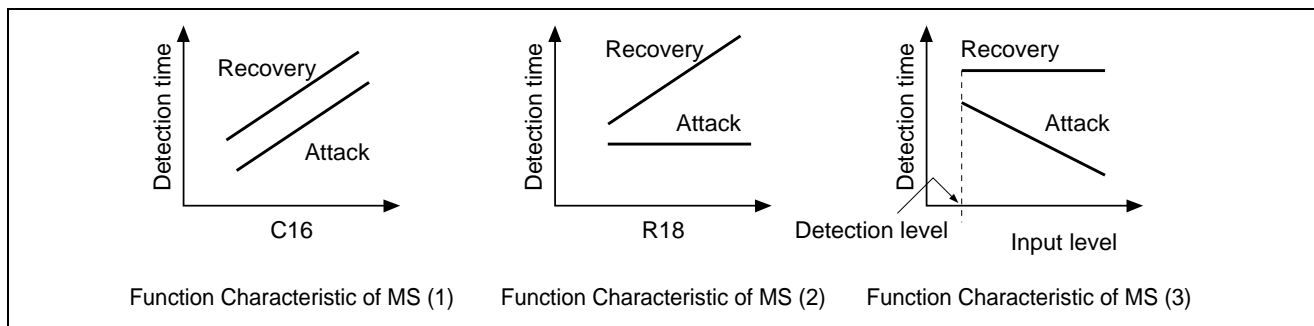

Figure 6 Function Characteristic of MS

Like the figure 6(2), Recovery time is variably possible by value of resistor R18. But Attack time gets about fixed value. Attack time has dependence by input level. When a large signal is inputted, Attack time is short tendency.

- Notes 2. Attack : Non- music to Music
 3. Recovery : Music to Non-music

- Music Sensor Output (MSOUT)

As for internal circuit of music sensor block, music sensor out pin is connected to the collector of NPN type directly, output level will be “high” when sensing no signal. And output level will be “low” when sensing signal.

Connection with microcomputer, it is requested to use external pull up resistor ($R_L = 10 \text{ k}\Omega$ to $22 \text{ k}\Omega$)

Note: Supply voltage of MSOUT pin must be less than V_{CC} voltage.

The Tolerances of External Components

For Dolby NR precision securing, please use external components shown at figure 7. If leak-current are a few electrolytic-capacitor, it can be applicable to C5 and C23.

Note: As Dolby-NR aren't built-in at HA12204NT, R3, C5 and C23 aren't necessary.

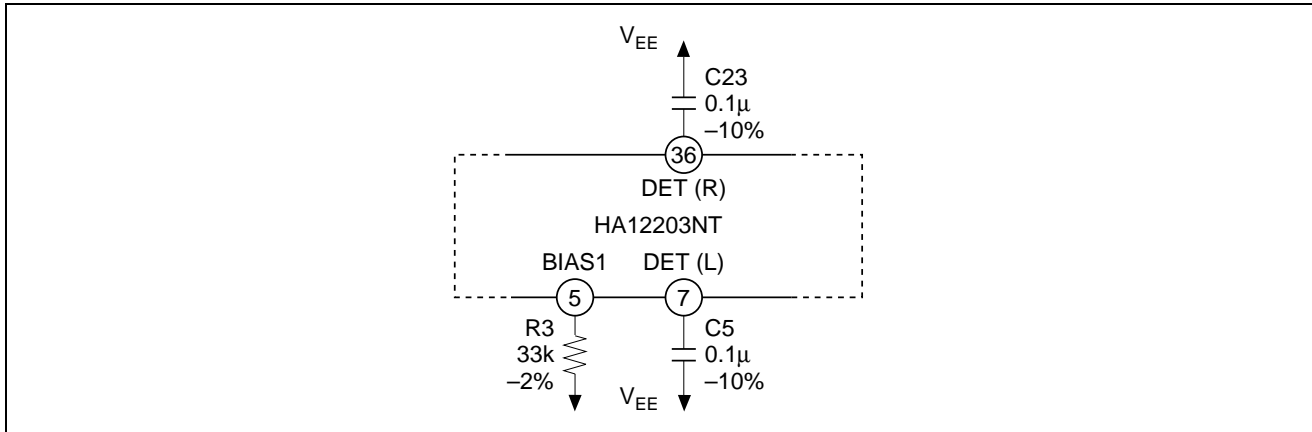

Figure 7 Tolerance of External Components

Low-Boost

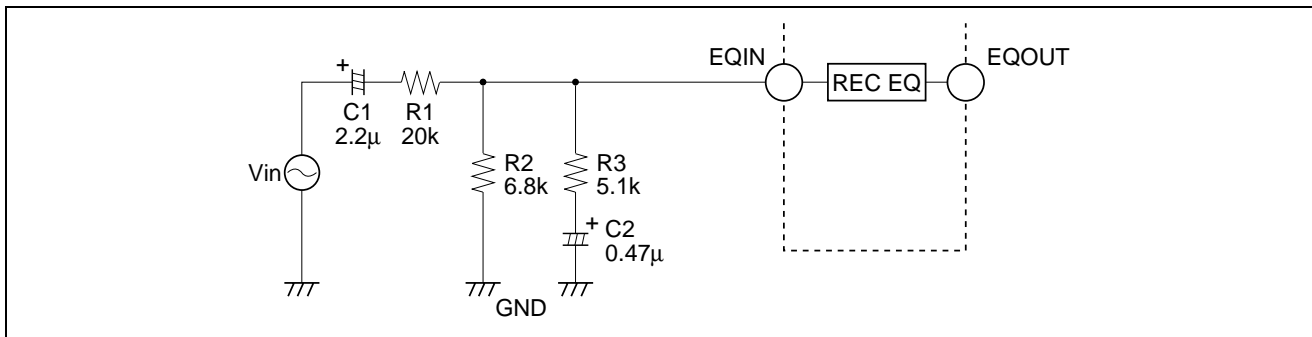

Figure 8 Example of Low Boost Circuit

External components shown Figure 8 gives Frequency response to take 6dB boost. And cut off Frequency can request it, by lower formulas.

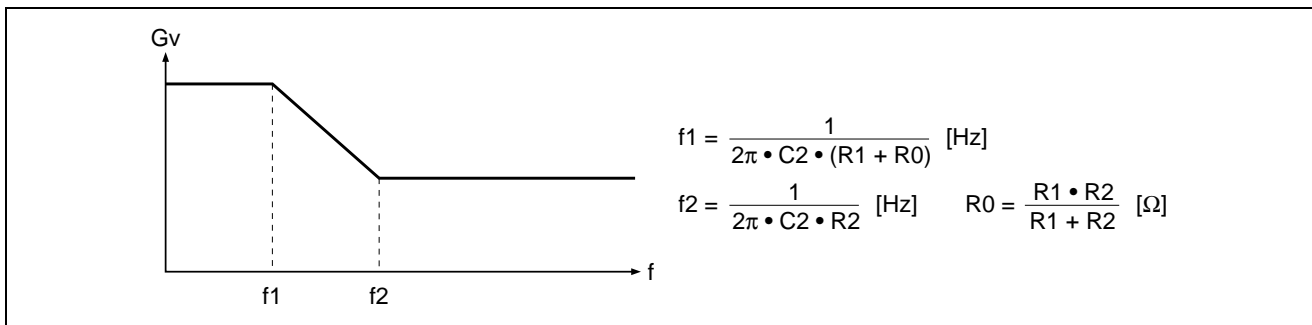

Figure 9 Frequency Characteristic of Low-Boost

REC Equalizer

The outlines of REC Equalizing frequency characteristics are shown by figure 10. Those peak level can be set up by supplying voltage. (0 V to 5 V, GND = 0 V) to 30pin (GPCAL).

And whole band gain can be set up by supplying voltage (0 V to 5 V, GND = 0 V) to 31pin (RECCAL).

Both setting up range are $\pm 4.5\text{dB}$. In case that you don't need setting up, 30 pin, 31pin should be open bias.

Note: Depending on the employed REC/PB head and test tape characteristics, there is a rare case that the REC-EQ characteristics of this LSI can not be matched to the required characteristics because of built-in resistors which determined the REC-EQ parameters in this case, please inquire the responsible agent because of the adjustment of built-in resistor is necessary.

Since an output pin and an input pin for REC-EQ are adjacent, it will easily oscillate if patterns run abreast.

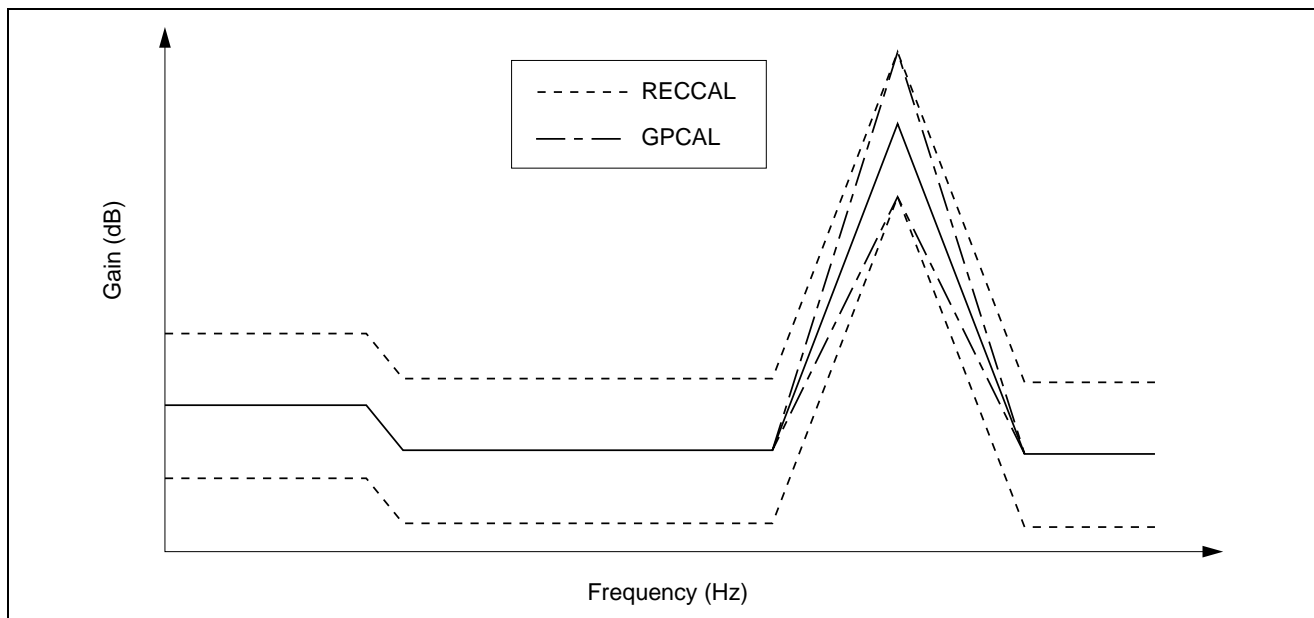

Figure 10 Frequency Characteristics of REC Equalizer

Bias Switch

This series built-in DC voltage generator for bias oscillator and its bias switches.

External resistor R15, R16, R17 Which corresponded with tape positions and bias out voltage are related with below.

$$V_{bias} \doteq \left(\frac{R_{14}}{(R_{15 \text{ or } R16 \text{ or } R17}) + R_{14}} \right) \times (V_{CC} - V_{EE} - 0.7) + V_{EE} \quad [V]$$

Bias switch follows to a logic of 15 pin (B / Norm / Crom / Metal).

Note: A current that flows at bias out pin, please use it less than 5 mA.

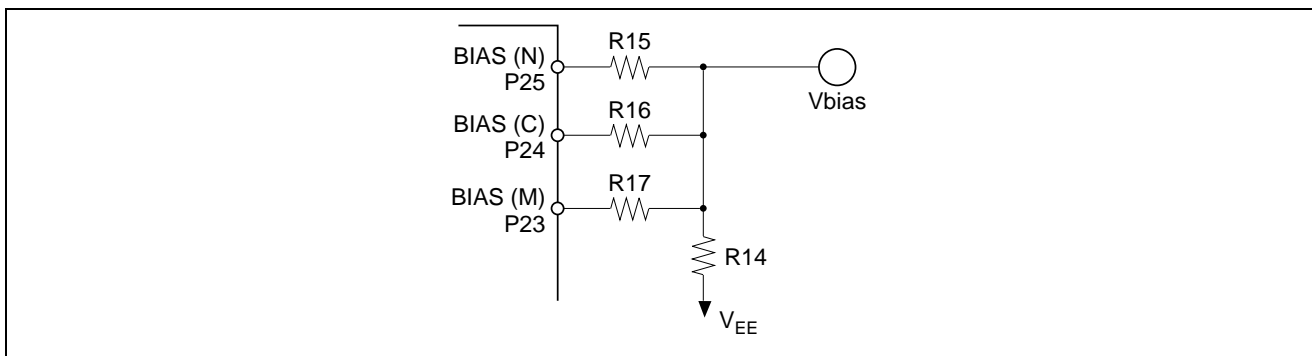

Figure 11 External Components of Bias Block

Absolute Maximum Ratings

Item	Symbol	Rating	Unit	Note
Max Supply Voltage	V_{cc} max	16	V	
Power Dissipation	Pd	500	mW	Ta ≤ 75°C
Operating Temperature	Topr	– 40 to + 75	°C	
Storage Temperature	Tstg	– 55 to + 125	°C	

HA12203NT/HA12204NT

Electrical Characteristics

HA12203NT

(Ta = 25°C, V_{CC} = ±7 V, Dolby Level = REC - OUT Level = 300 mV_{rms} = 0 dB)

Item	Symbol	Test Condition					Specification				Application Terminal			Remark					
		IC Condition *					RECOULT level (dB)	Other	Unit			Input			Output				
		NR ON/OFF	REC/PB /PASS	A/B	120μ/70μ	LINE MUTE			f _{in} (Hz)	Min	Typ	Max	mA		dB	dB	R	L	R
Quiescent current	I _Q	OFF	PB	A	120	Mute	—	No signal	—	22.0	35.0	—	—	—	—	—	—	22	—
Input AMP. gain	G _V PB	OFF	PB	A/B	120	OFF	1k	0	—	25.5	27.0	28.5	—	—	2/4	41/39	8	35	—
	G _V REC	OFF	REC	A	120	OFF	1k	0	—	21.2	22.7	24.2	—	—	6	37	8	35	—
	B-type Encode boost	ENC 2k (1)	ON	REC	A	120	OFF	2k	-20	—	2.8	4.3	5.8	dB	6	37	9	34	—
	ENC 2k (2)	ON	REC	A	120	OFF	2k	-30	—	7.0	8.5	10.0	—	—	6	37	9	34	—
	ENC 5k (1)	ON	REC	A	120	OFF	5k	-20	—	1.7	3.2	4.7	—	—	6	37	9	34	—
	ENC 5k (2)	ON	REC	A	120	OFF	5k	-30	—	6.7	8.2	9.7	—	—	6	37	9	34	—
Signal handling	V _o max	ON	REC	A	120	OFF	1k	—	THD=1%	12.0	13.0	—	dB	—	6	37	9	34	—
Signal to noise ratio	S/N	ON	REC	A	120	OFF	1k	—	Rg=5.1kΩ, CCIR/ARM	64.0	70.0	—	dB	—	6	37	9	34	—
Total Harmonic Distortion	THD	ON	REC	A	120	OFF	1k	0	—	—	0.05	0.3	%	—	6	37	9	34	—
Channel separation	CTRL (1)	OFF	PB	A/B	120	OFF	1k	+12	—	70.0	80.0	—	dB	—	2/4	41/39	8	35	—
	CTRL (2)	OFF	REC	A	120	OFF	1k	+12	—	70.0	85.0	—	dB	—	6	37	8	35	—
Crosstalk	CT A/B	OFF	PB	A/B	120	OFF	1k	+12	—	70.0	80.0	—	dB	—	2/4	41/39	8	35	—
	CT R/P	OFF	REC/PB	A/B	120	OFF	1k	+12	—	70.0	80.0	—	dB	—	2/4/6	41/39 /37	8	35	—
Pass AMP. gain	G _V PA	OFF	PASS	A/B	120	OFF	1k	0	G _V PA - G _V PB	25.5	27.0	28.5	dB	—	2/4	41/39	8	35	—
Gain deviation	ΔG _V	OFF	PASS	A/B	120	OFF	1k	0	—	-1.0	0.0	1.0	dB	—	2/4	41/39	8	35	—
MUTE ATT.	MUTE	OFF	PB	A	120	ON	1k	+12	—	70.0	80.0	—	dB	—	2	41	8	35	—
70μ EQ gain	G _V EQ 1k	OFF	PB	A/B	70	OFF	1k	0	—	24.0	25.5	27.0	dB	—	2/4	41/39	8	35	—
	G _V EQ 10k	OFF	PB	A/B	70	OFF	10k	0	—	20.8	22.3	23.8	dB	—	2/4	41/39	8	35	—
MS sensing level	V _{ON}	OFF	PB	A	120	OFF	5k	—	—	-26.0	-22.0	-18.0	dB	—	2	41	—	—	21
MS output low level	V _{OL}	OFF	PB	A	120	OFF	—	—	—	—	1.0	1.5	V	—	2	41	—	—	21
MS output leak current	I _{OH}	OFF	PB	A	120	OFF	—	—	—	—	—	2.0	μA	—	—	—	—	—	21
Control voltage	V _{IL}	—	—	—	—	—	—	—	—	-0.2	—	1.0	V	—	—	—	—	—	12 to 20
	V _{IM}	—	—	—	—	—	—	—	—	2.0	—	3.0	—	—	—	—	—	—	12 to 20
	V _{IH}	—	—	—	—	—	—	—	—	4.0	—	5.3	—	—	—	—	—	—	12 to 20

Notes 1. V_{CC} = ±6.0 V

2. For inputting signal to one side channel

* Other IC-condition : REC-MUTE OFF, Normal tape, Normal speed, Bias OFF

HA12203NT (cont)

(Ta = 25 °C, V_{CC} = ± 7 V)

Item	Symbol	Test Condition			Specification			Unit			Application Terminal			Remark	
					Min	Typ	Max	Input	Output	COM	Input		Output		
											R	L	R		L
Equalizer S/N	S/N (EQ)	NORM	NORM	NORM	Rg = 5.1kΩ, A - WTG Filter (0dB = -5dBs at EQOUT)	55	58	—	dB	10	33	11	32	—	
Equalizer maximum input	V _{in max} (EQ)	NORM	NORM	NORM	f = 1kHz, THD = 1%, V _{in} = -26dBs = 0dB	10.5	12.5	—	dB	10	33	11	32	—	
Equalizer Total Harmonic Distortion	T.H.D. (EQ)	NORM	NORM	NORM	f = 1kHz, V _{in} = -26dBs	—	0.2	0.5	%	10	33	11	32	—	
Equalizer offset voltage	V _{ofs} (EQ)	NORM	NORM	NORM	No - Signal	-500	0	500	mV	10	33	11	32	—	
Equalizer Frequency Response (NORM - NORM)	GVEQ-NN1	NORM	NORM	NORM	f = 3kHz, V _{in} = -46dBs	18.8	20.3	21.8	dB	10	33	11	32	—	
	GVEQ-NN2	NORM	NORM	NORM	f = 8kHz, V _{in} = -46dBs	23.9	25.9	27.9	dB	10	33	11	32	—	
	GVEQ-NN3	NORM	NORM	NORM	f = 12kHz, V _{in} = -46dBs	30.1	32.6	35.1	dB	10	33	11	32	—	
Equalizer Frequency Response (CROM - NORM)	GVEQ-CN1	CROM	NORM	NORM	f = 3kHz, V _{in} = -46dBs	24.0	25.5	27.0	dB	10	33	11	32	—	
	GVEQ-CN2	CROM	NORM	NORM	f = 8kHz, V _{in} = -46dBs	29.8	31.8	33.8	dB	10	33	11	32	—	
	GVEQ-CN3	CROM	NORM	NORM	f = 12kHz, V _{in} = -46dBs	36.3	38.8	41.3	dB	10	33	11	32	—	
Equalizer Frequency Response (METAL - NORM)	GVEQ-MN1	METAL	NORM	NORM	f = 3kHz, V _{in} = -46dBs	24.8	26.3	27.8	dB	10	33	11	32	—	
	GVEQ-MN2	METAL	NORM	NORM	f = 8kHz, V _{in} = -46dBs	27.8	29.8	31.8	dB	10	33	11	32	—	
	GVEQ-MN3	METAL	NORM	NORM	f = 12kHz, V _{in} = -46dBs	31.4	33.9	36.4	dB	10	33	11	32	—	
Equalizer Frequency Response (NORM - High)	GVEQ-NH1	NORM	HIGH	HIGH	f = 5kHz, V _{in} = -46dBs	14.9	16.4	17.9	dB	10	33	11	32	—	
	GVEQ-NH2	NORM	HIGH	HIGH	f = 15kHz, V _{in} = -46dBs	20.2	22.2	24.2	dB	10	33	11	32	—	
	GVEQ-NH3	NORM	HIGH	HIGH	f = 20kHz, V _{in} = -46dBs	24.1	26.6	29.1	dB	10	33	11	32	—	
Equalizer Frequency Response (CROM - High)	GVEQ-CH1	CROM	HIGH	HIGH	f = 5kHz, V _{in} = -46dBs	20.7	22.2	23.7	dB	10	33	11	32	—	
	GVEQ-CH2	CROM	HIGH	HIGH	f = 15kHz, V _{in} = -46dBs	25.1	27.1	29.1	dB	10	33	11	32	—	
	GVEQ-CH3	CROM	HIGH	HIGH	f = 20kHz, V _{in} = -46dBs	28.6	31.1	33.3	dB	10	33	11	32	—	
Equalizer Frequency Response (METAL - High)	GVEQ-MH1	METAL	HIGH	HIGH	f = 5kHz, V _{in} = -46dBs	21.9	23.4	24.9	dB	10	33	11	32	—	
	GVEQ-MH2	METAL	HIGH	HIGH	f = 15kHz, V _{in} = -46dBs	23.8	25.8	27.8	dB	10	33	11	32	—	
	GVEQ-MH3	METAL	HIGH	HIGH	f = 20kHz, V _{in} = -46dBs	26.0	28.5	31.0	dB	10	33	11	32	—	
REC - MUTE Attenuation	REC-MUTE	NORM	NORM	f = 1kHz, V _{in} = -14dBs	60	70	—	dB	10	33	11	32	—		
REC CAL Response	R-CAL1	NORM	NORM	NORM	f = 3kHz, V _{in} = -46dBs, V _{REC-CAL} = 5V	3.0	4.5	6.0	dB	10	33	11	32	—	
	R-CAL2	NORM	NORM	NORM	f = 3kHz, V _{in} = -46dBs, V _{REC-CAL} = 0V	-6.0	-4.5	-3.0	dB	10	33	11	32	—	
	GP-CAL1	NORM	NORM	NORM	f = 12kHz, V _{in} = -46dBs, V _{GP-CAL} = 0V	3.0	4.5	6.0	dB	10	33	11	32	—	
GP CAL Response	GP-CAL2	NORM	NORM	NORM	f = 12kHz, V _{in} = -46dBs, V _{GP-CAL} = 5V	-6.0	-4.5	-3.0	dB	10	33	11	32	—	
Bias out Max level	Bias on				R _L = 2.4kΩ + 270Ω	V _{CC}	-1.4	-0.7	V	—	—	—	—	25	
Bias out offset	Bias off				R _L = 2.4kΩ + 270Ω	-100	0	100	mV	—	—	—	—	25	

HA12203NT/HA12204NT

HA12204NT

(Ta = 25°C, V_{CC} = ±7 V, REC - OUT Level = 300 mV_{rms} = 0 dB)

Item	Symbol	Test Condition										Unit	Application Terminal				Remark			
		IC Condition *					Other						Min	Typ	Max	Input		Output		
		REC/PB/PASS	A/B	120μ/70μ	LINE MUTE	Mute	fin (Hz)	RECOULT level (dB)								R		L	R	L
Quiescent current	I _Q	PB	A	120	Mute	—	—	No signal	—	19.2	25.0	mA	—	—	—	—	—	—	22	
Input AMP. gain	G _V PB	PB	A/B	120	OFF	1k	0		25.5	27.0	28.5	dB	2/4	41/39	8	35	—	—	—	
	G _V REC	REC	A	120	OFF	1k	0		21.2	22.7	24.2		6	37	8	35	—	—	—	
Signal handling	V _O max	REC	A	120	OFF	1k	—	THD=1%	12.0	13.0		dB	6	37						1)
Signal to noise ratio	S/N	REC	A	120	OFF	1k	—	Rg=5.1kΩ, CCIR/ARM	70.0	80.0	—	dB	6	37	8	35	—	—	—	
Total Harmonic Distortion	THD	REC	A	120	OFF	1k	0		—	0.05	0.3	%	6	37	8	35	—	—	—	
Channel separation	CTRL (1)	PB	A/B	120	OFF	1k	+12		70.0	80.0	—	dB	2/4	41/39	8	35	—	—	—	
	CTRL (2)	REC	A	120	OFF	1k	+12		70.0	85.0	—	dB	6	37	8	35	—	—	—	
Crosstalk	CT A/B	PB	A/B	120	OFF	1k	+12		70.0	80.0	—	dB	2/4	41/39	8	35	—	—	—	
	CT R/P	REC/PB	A/B	120	OFF	1k	+12		70.0	80.0	—	dB			8	35	—	—	—	
Pass AMP. gain	G _V PA	PASS	A/B	120	OFF	1k	0		25.5	27.0	28.5	dB	2/4	41/39	8	35	—	—	—	
Gain deviation	ΔG _V	PASS	A/B	120	OFF	1k	0	G _V PA – G _V PB	-1.0	0.0	1.0	dB	2/4	41/39	8	35	—	—	—	
MUTE ATT.	MUTE	PB	A	120	ON	1k	+12		70.0	80.0	—	dB	2	41	8	35	—	—	—	
70μ EQ gain	G _V EQ 1k	PB	A/B	70	OFF	1k	0		24.0	25.5	27.0	dB	2/4	41/39	8	35	—	—	—	
	G _V EQ 10k	PB	A/B	70	OFF	10k	0		20.8	22.3	23.8	dB	2/4	41/39	8	35	—	—	—	
MS sensing level	V _{ON}	PB	A	120	OFF	5k	—		-26.0	-22.0	-18.0	dB	2	41	—	—	—	—	2)	
MS output low level	V _{OL}	PB	A	120	OFF	—	—		—	1.0	1.5	V	2	41	—	—	—	—	—	
MS output leak current	I _{OH}	PB	A	120	OFF	—	—		—	—	2.0	μA	—	—	—	—	—	—	—	
Control voltage	V _{IL}	—	—	—	—	—	—		-0.2	—	1.0	V	—	—	—	—	—	—	12 to 17	
	V _{IM}	—	—	—	—	—	—		2.0	—	3.0	V	—	—	—	—	—	—	12 to 17	
	V _H	—	—	—	—	—	—		4.0	—	5.3	V	—	—	—	—	—	—	12 to 17	
																				19,20

Note 1) V_{CC} = ±6V

2) For inputting signal to one side channel

* Other IC-condition : REC-MUTE OFF, Normal tape, Normal speed, Bias OFF

HA12204NT (cont)

(Ta = 25 °C, V_{CC} = ± 7 V)

Item	Symbol	Test Condition			Specification		Unit				Application Terminal			Remark	
		TAPE	SPEED		Min	Typ	Max				Input		Output		
											R	L	R		L
Equalizer S/N	S/N (EQ)	NORM	NORM	Rg = 5.1kΩ, A - WTG Filter (0dB = -5dBs at EQOUT)	55	58	—	dB	10	33	11	32	—		
Equalizer maximum input	V _{in} max (EQ)	NORM	NORM	f = 1kHz, THD = 1%, V _{in} = -26dBs = 0dB	10.5	12.5	—	dB	10	33	11	32	—		
Equalizer Total Harmonic Distortion	T.H.D. (EQ)	NORM	NORM	f = 1kHz, V _{in} = -26dBs	—	0.2	0.5	%	10	33	11	32	—		
Equalizer offset voltage	V _{ofs} (EQ)	NORM	NORM	No - Signal	-500	0	500	mV	10	33	11	32	—		
Equalizer Frequency Response (NORM - NORM)	GVEQ-NN1	NORM	NORM	f = 3kHz, V _{in} = -46dBs	18.8	20.3	21.8	dB	10	33	11	32	—		
	GVEQ-NN2			f = 8kHz, V _{in} = -46dBs	23.9	25.9	27.9	dB	10	33	11	32	—		
	GVEQ-NN3			f = 12kHz, V _{in} = -46dBs	30.1	32.6	35.1	dB	10	33	11	32	—		
Equalizer Frequency Response (CROM - NORM)	GVEQ-CN1	CROM	NORM	f = 3kHz, V _{in} = -46dBs	24.0	25.5	27.0	dB	10	33	11	32	—		
	GVEQ-CN2			f = 8kHz, V _{in} = -46dBs	29.8	31.8	33.8	dB	10	33	11	32	—		
	GVEQ-CN3			f = 12kHz, V _{in} = -46dBs	36.3	38.8	41.3	dB	10	33	11	32	—		
Equalizer Frequency Response (NORM - High)	GVEQ-NH1	NORM	HIGH	f = 5kHz, V _{in} = -46dBs	14.9	16.4	17.9	dB	10	33	11	32	—		
	GVEQ-NH2			f = 15kHz, V _{in} = -46dBs	20.2	22.2	24.2	dB	10	33	11	32	—		
	GVEQ-NH3			f = 20kHz, V _{in} = -46dBs	24.1	26.6	29.1	dB	10	33	11	32	—		
Equalizer Frequency Response (CROM - High)	GVEQ-CH1	CROM	HIGH	f = 5kHz, V _{in} = -46dBs	20.7	22.2	23.7	dB	10	33	11	32	—		
	GVEQ-CH2			f = 15kHz, V _{in} = -46dBs	25.1	27.1	29.1	dB	10	33	11	32	—		
	GVEQ-CH3			f = 20kHz, V _{in} = -46dBs	28.6	31.1	33.3	dB	10	33	11	32	—		
REC - MUTE Attenuation	REC-MUTE	NORM	NORM	f = 1kHz, V _{in} = -14dBs	60	70	—	dB	10	33	11	32	—		
Bias out Max level	Bias on			R _L = 2.4 k $\frac{1}{2}$ + 270 $\frac{1}{2}$	V _{CC} -1.4	V _{CC} -0.7	—	V	—	—	—	—	—	25	
Bias out offset	Bias off			R _L = 2.4 k $\frac{1}{2}$ + 270 $\frac{1}{2}$	-100	0.0	100	mV	—	—	—	—	—	25	

HA12203NT/HA12204NT

Measurement Circuit

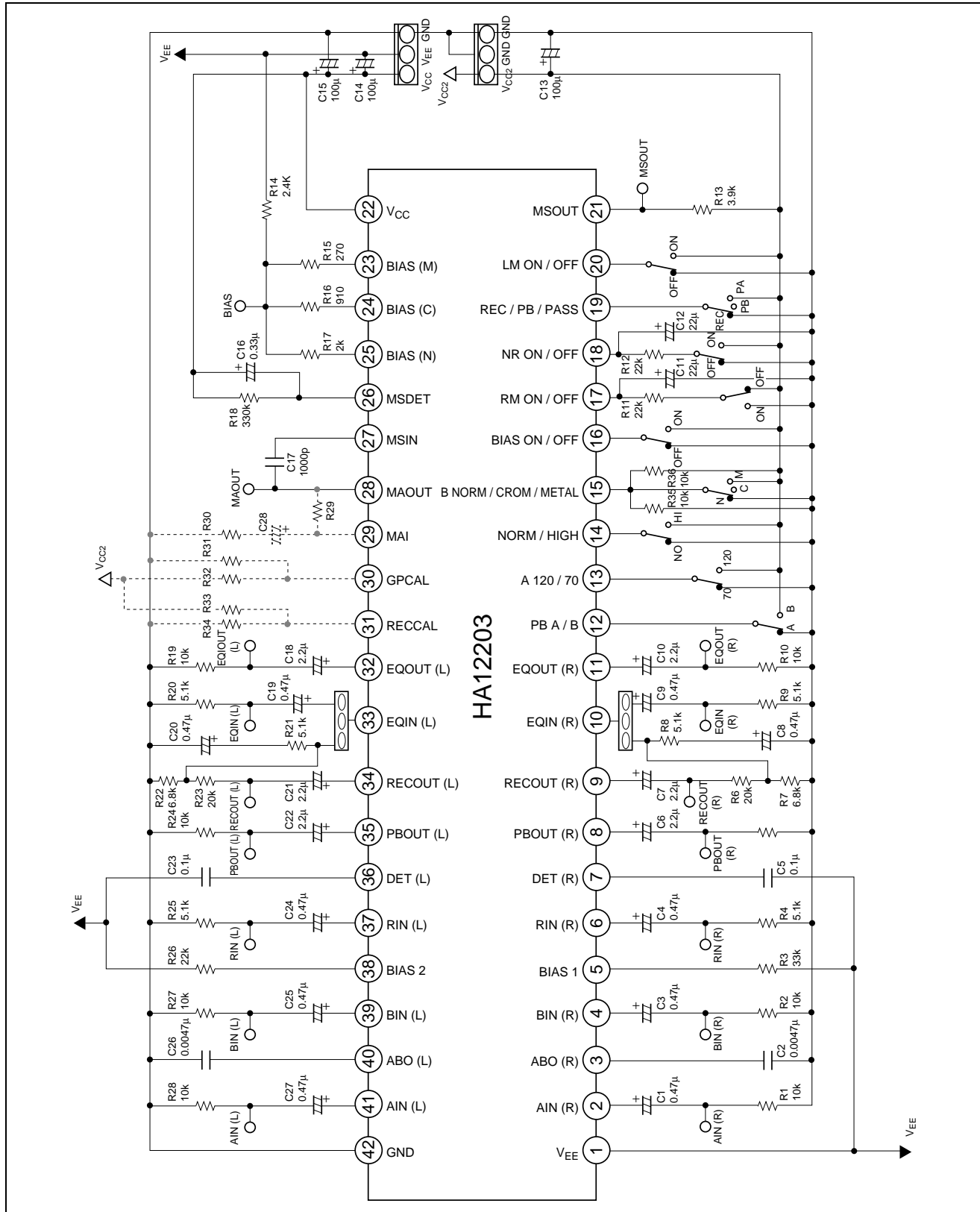

Electrical Characteristics Curve

HA12203NT

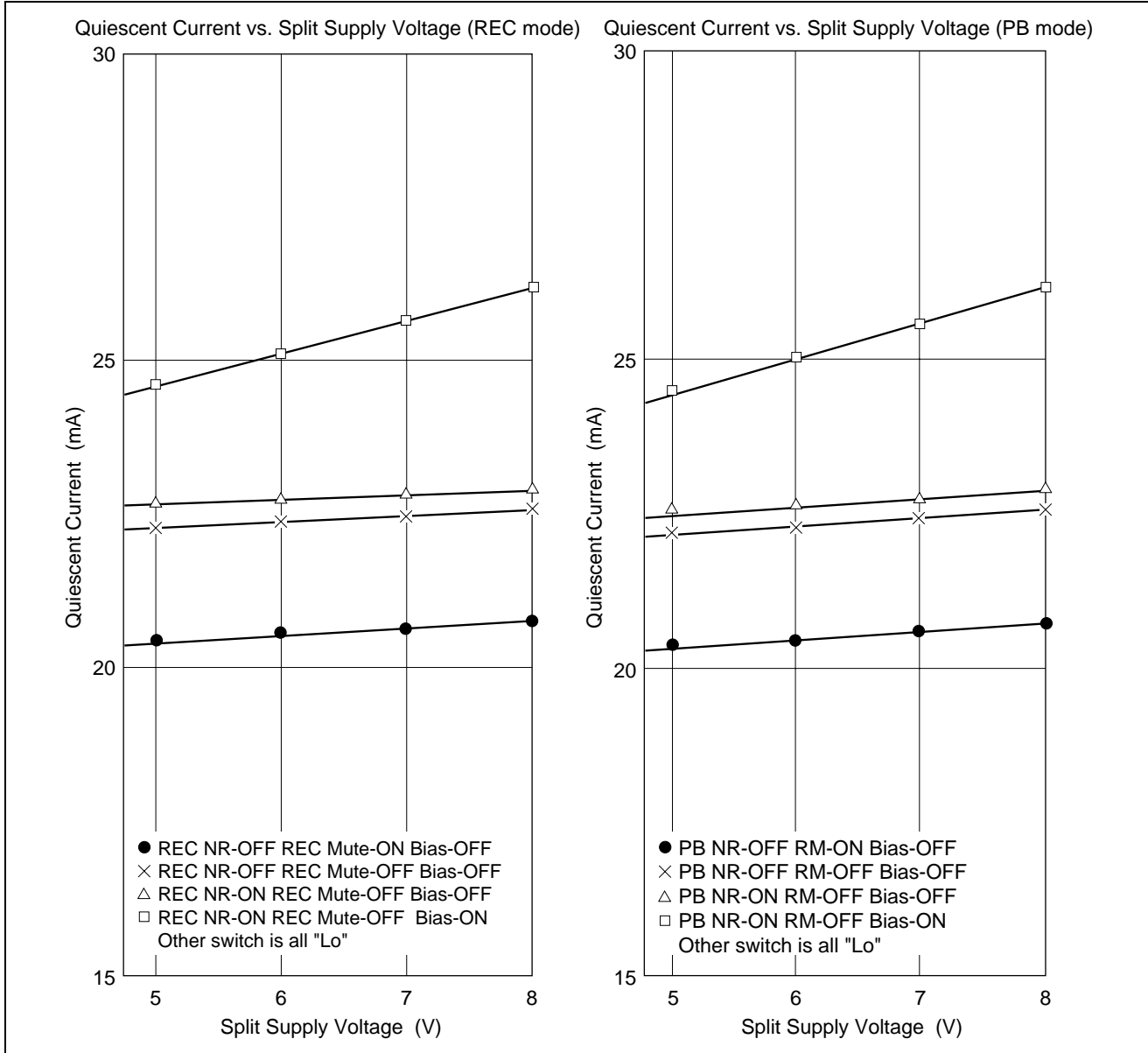

HA12203NT/HA12204NT

HA12203NT

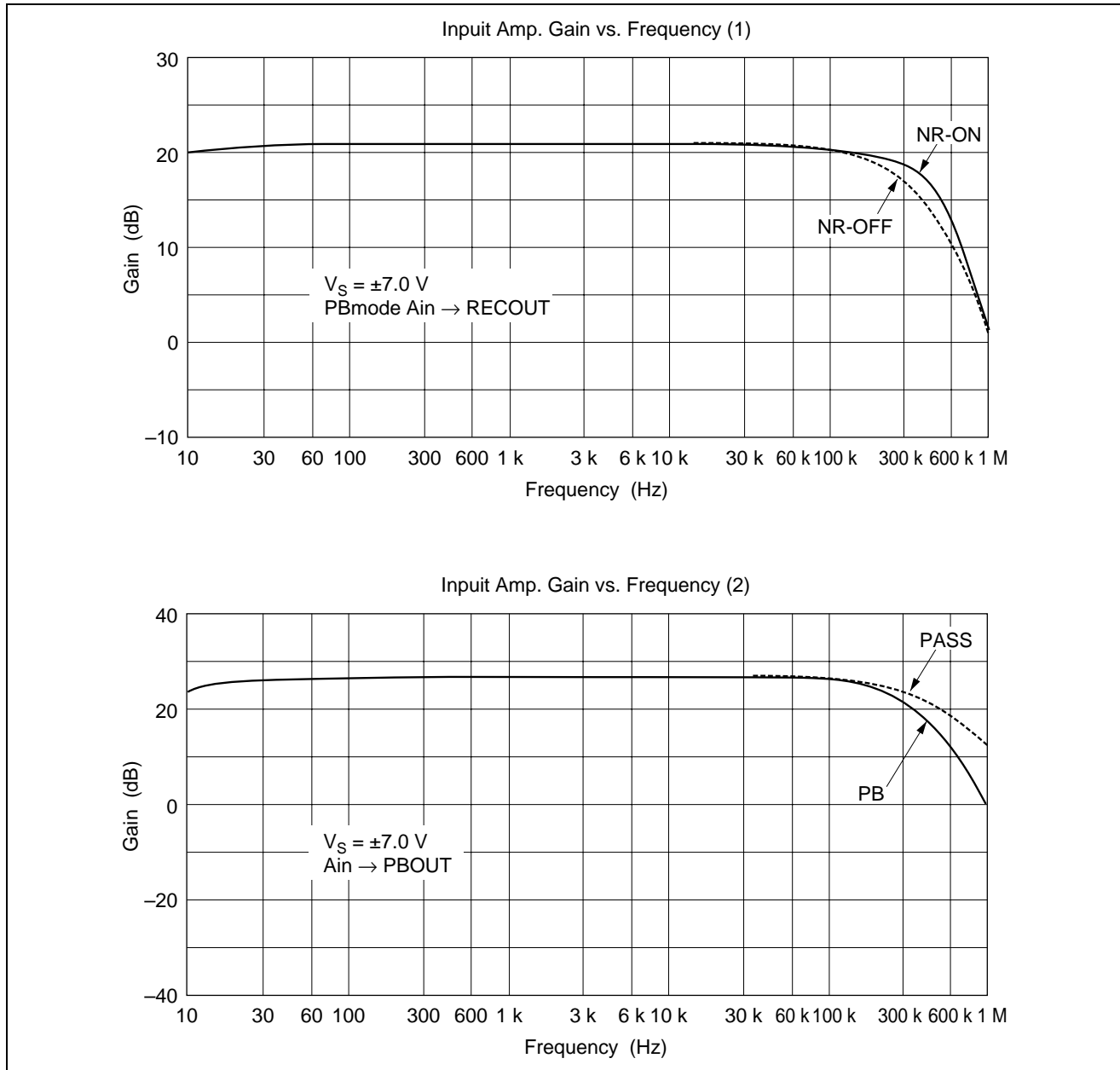

HA12203NT

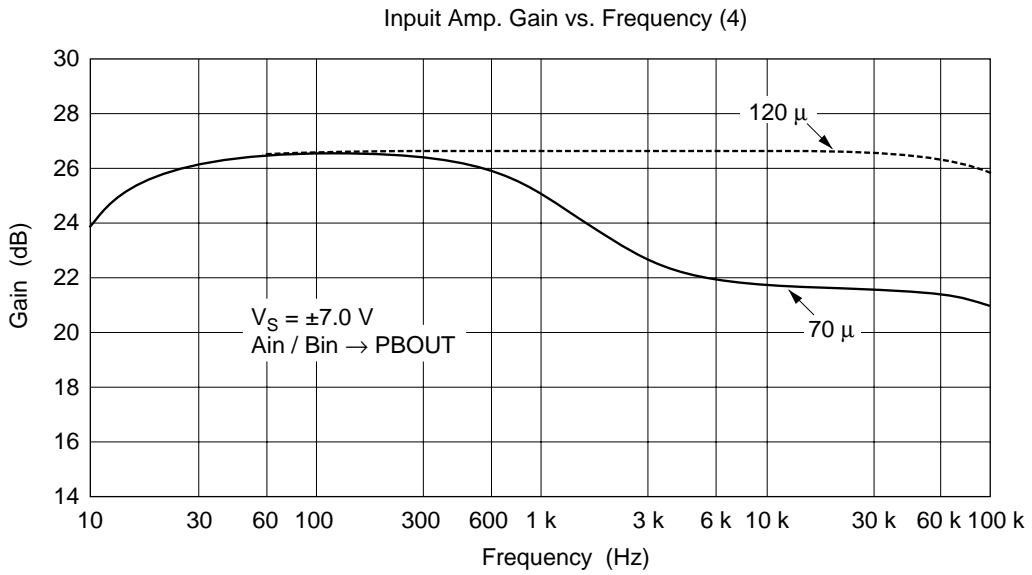
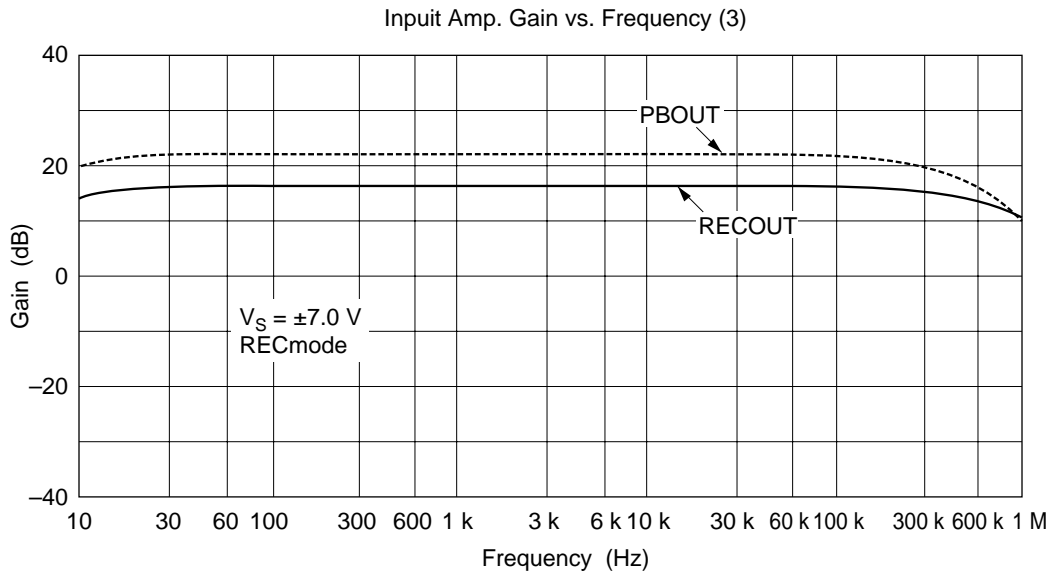

HA12203NT

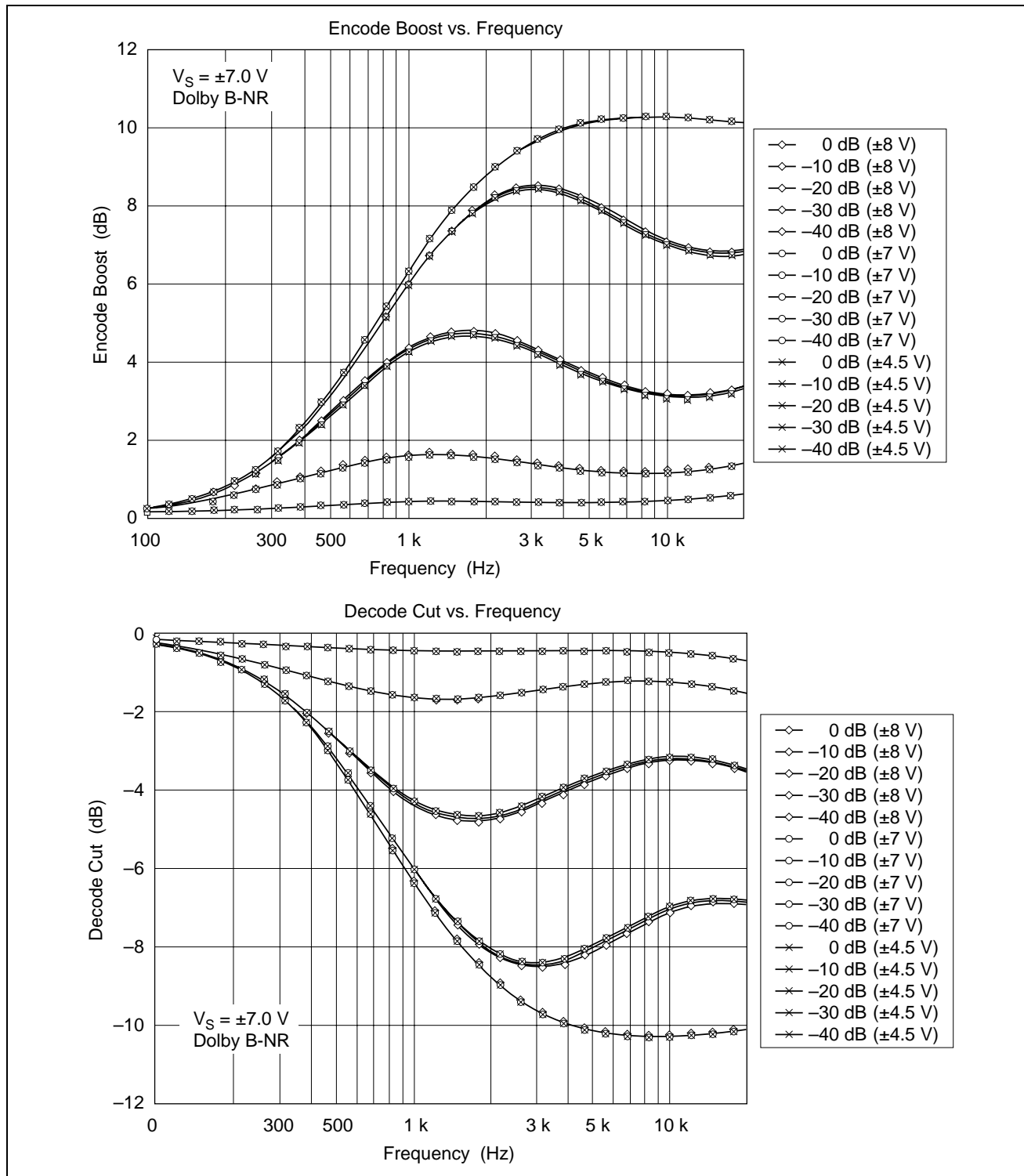

HA12203NT

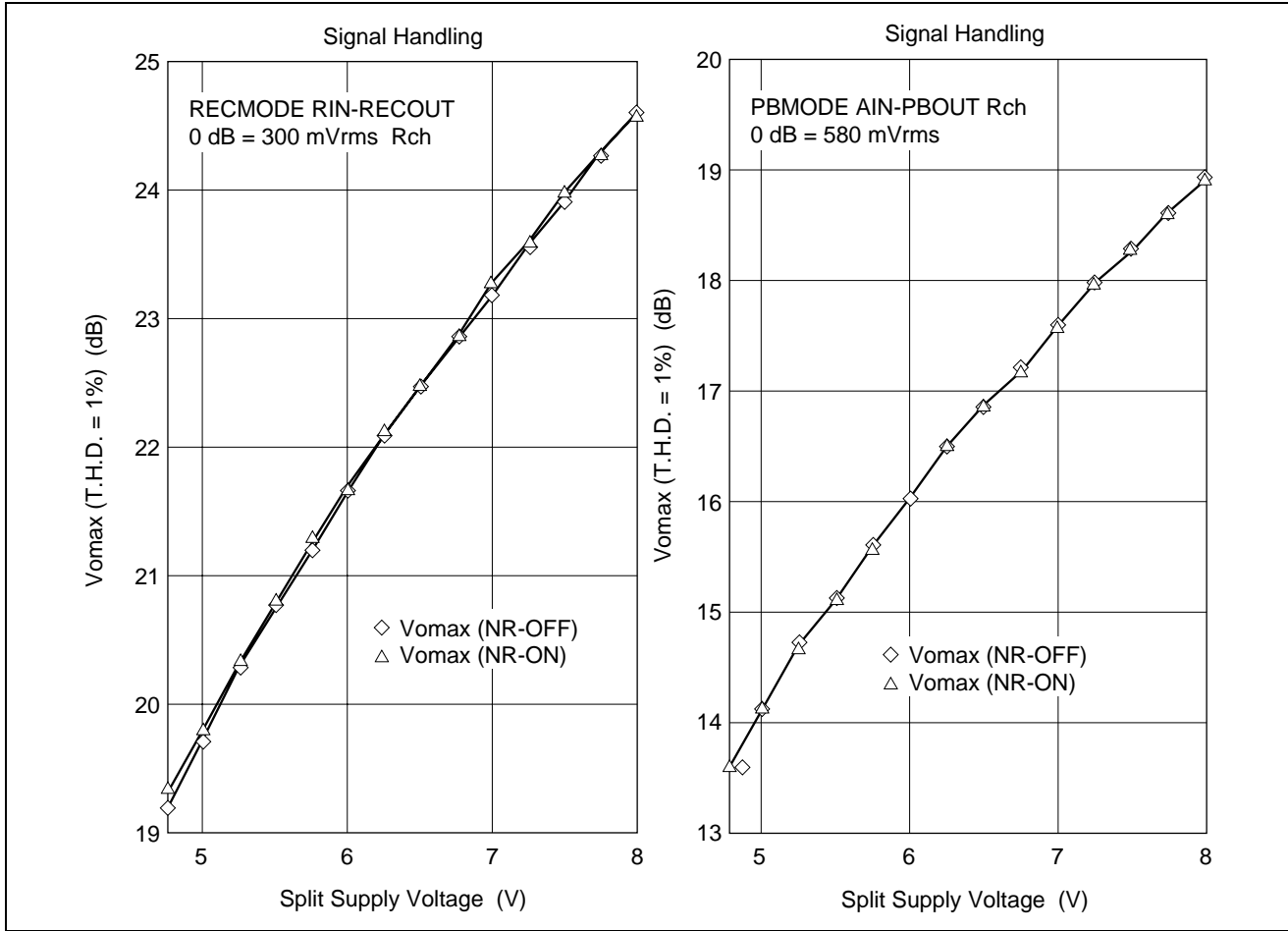

HA12203NT/HA12204NT

HA12203NT

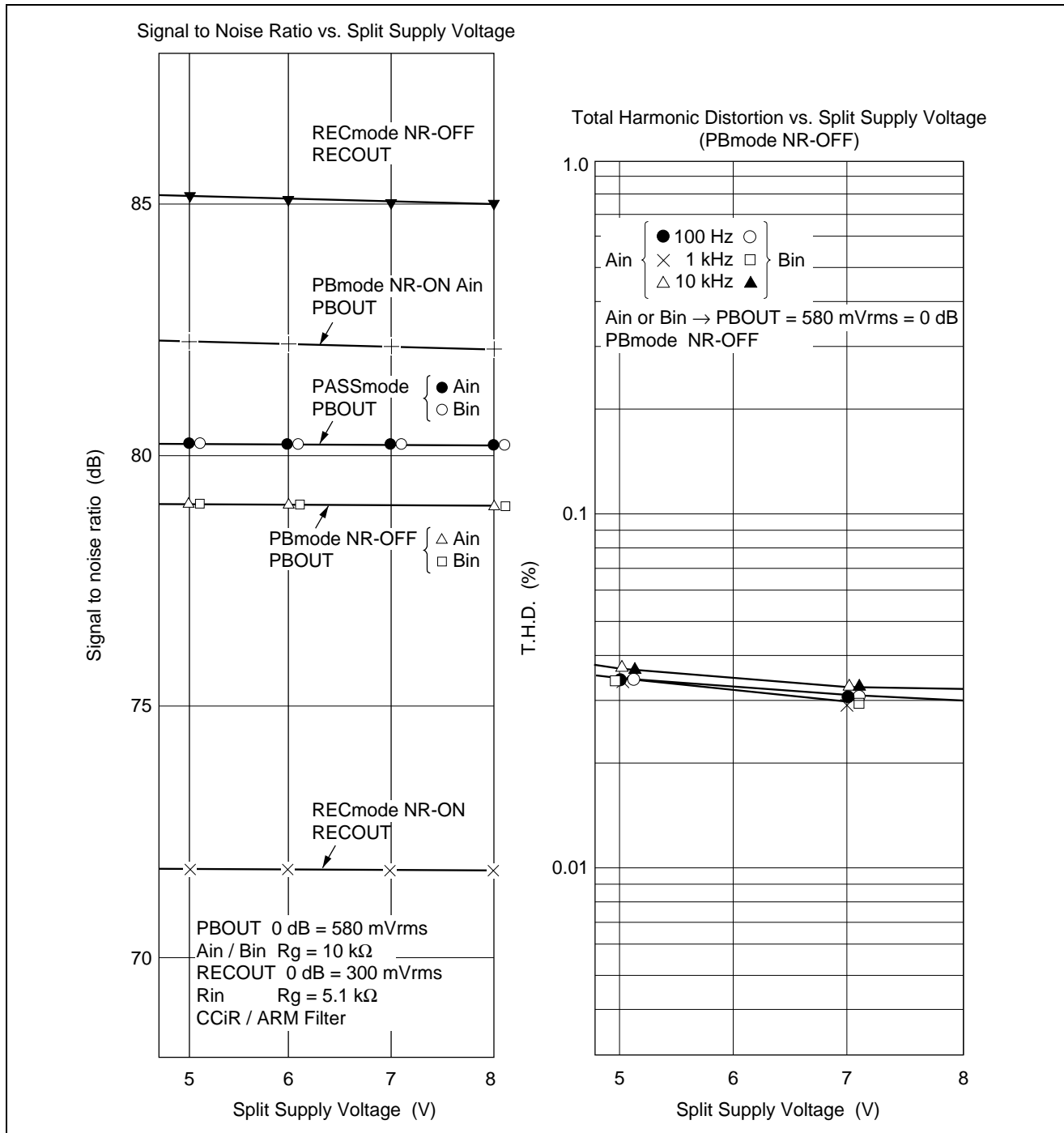

HA12203NT

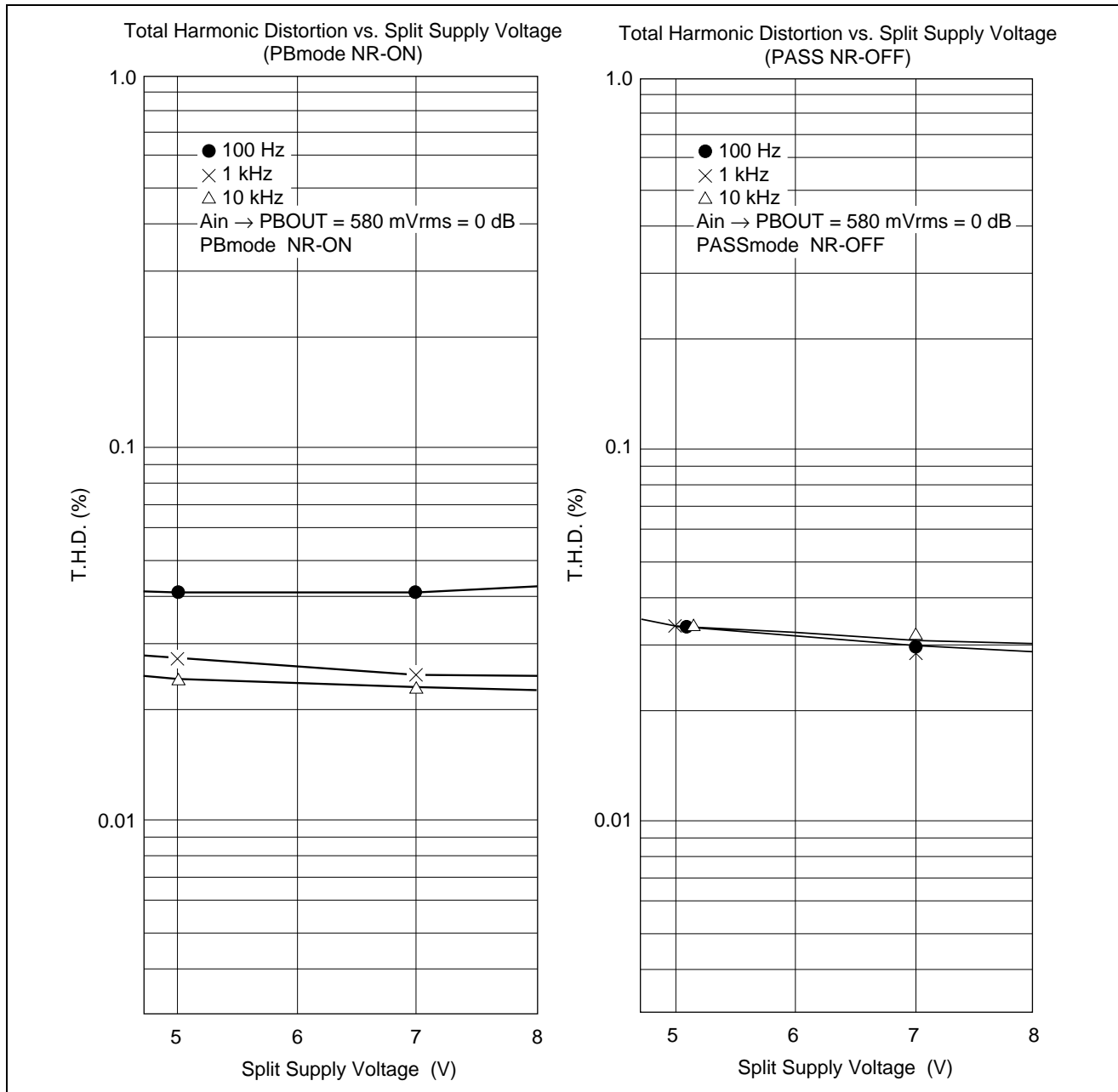

HA12203NT/HA12204NT

HA12203NT

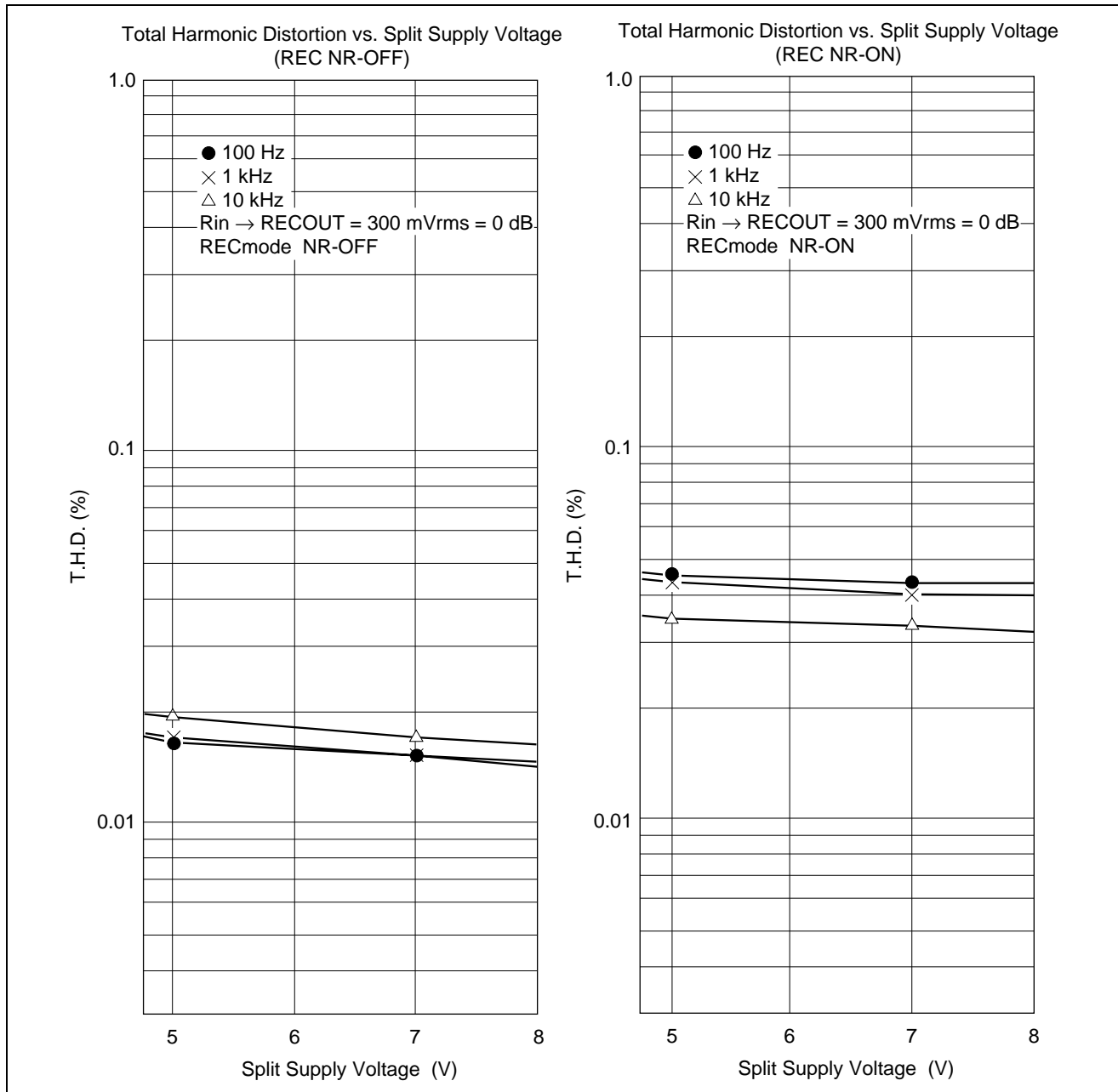

HA12203NT

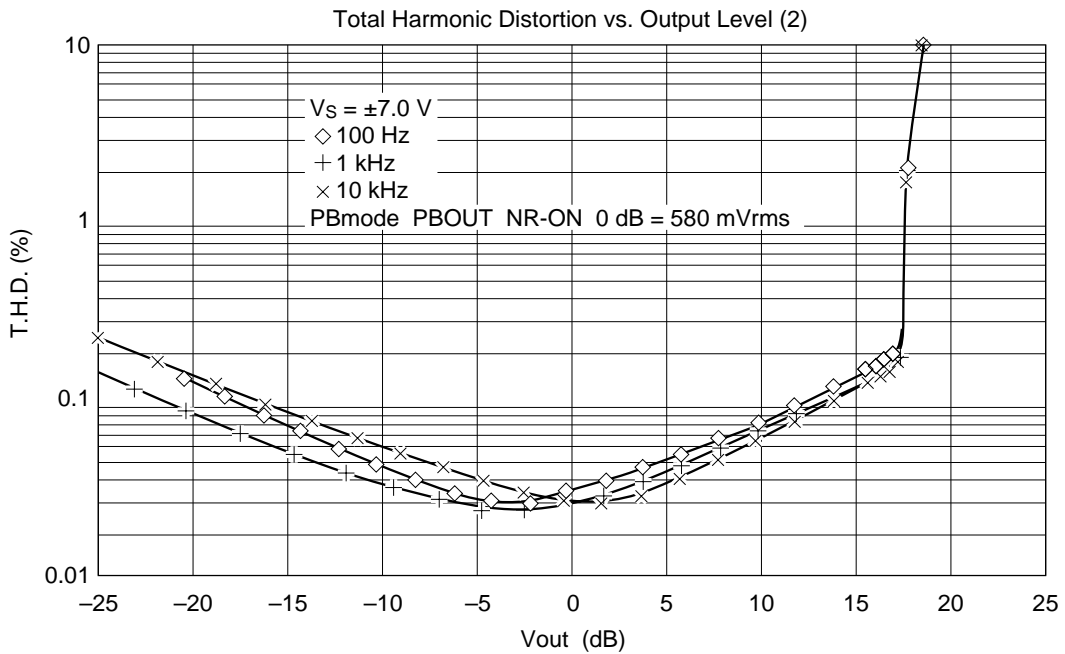
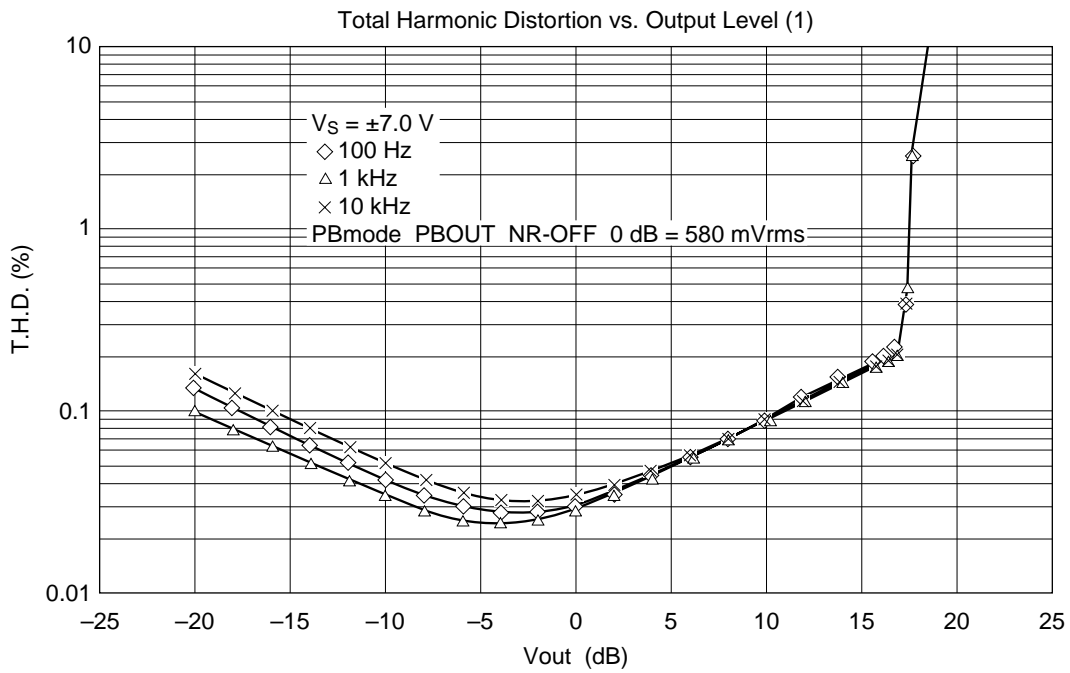

HA12203NT/HA12204NT

HA12203NT

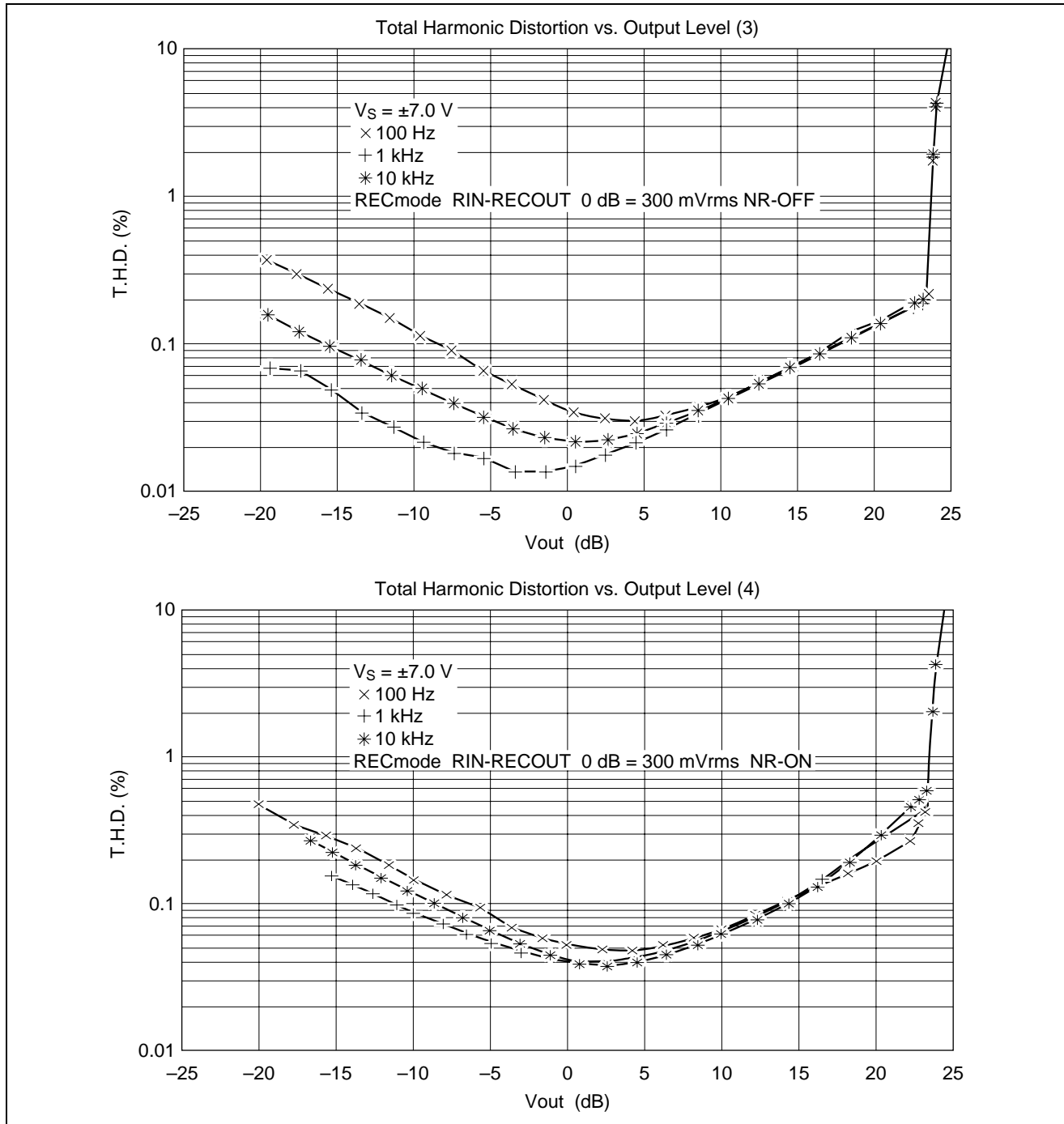

HA12203NT

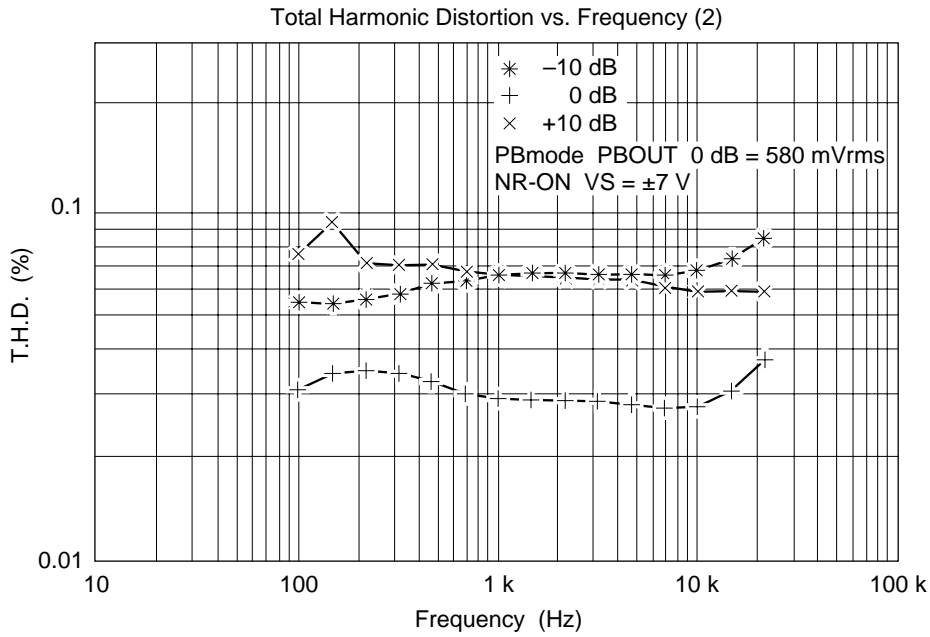
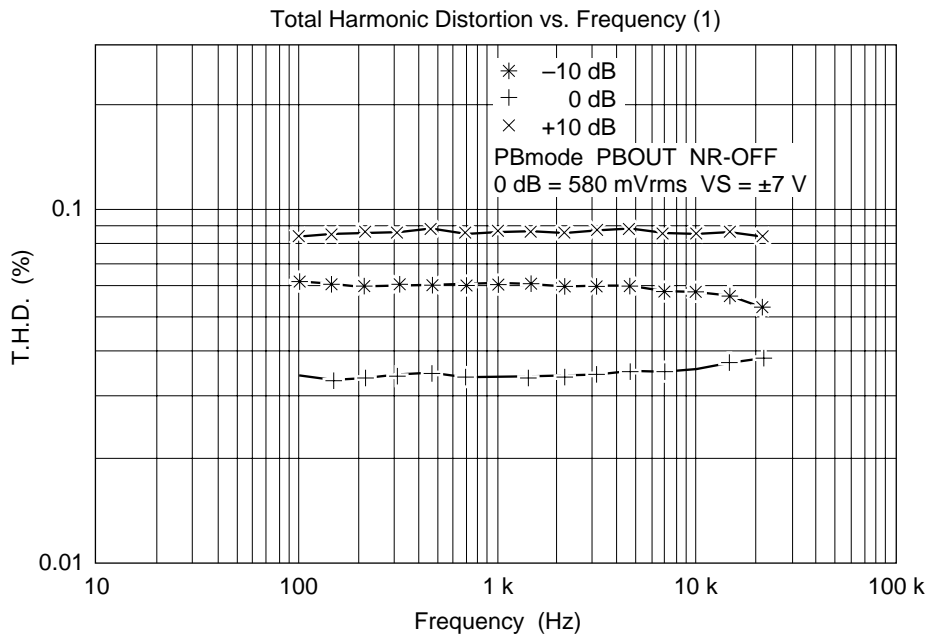

HA12203NT

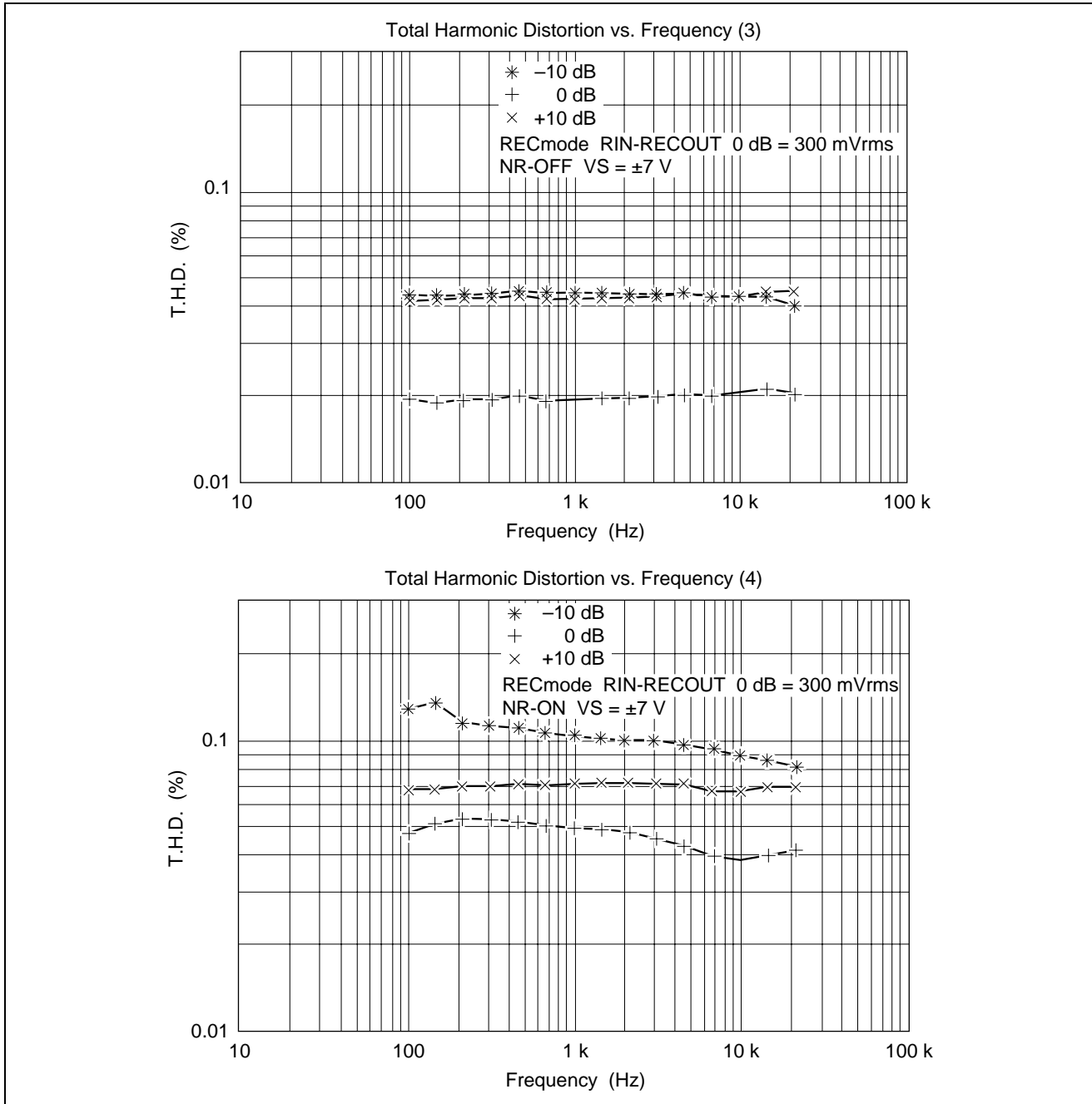

HA12203NT

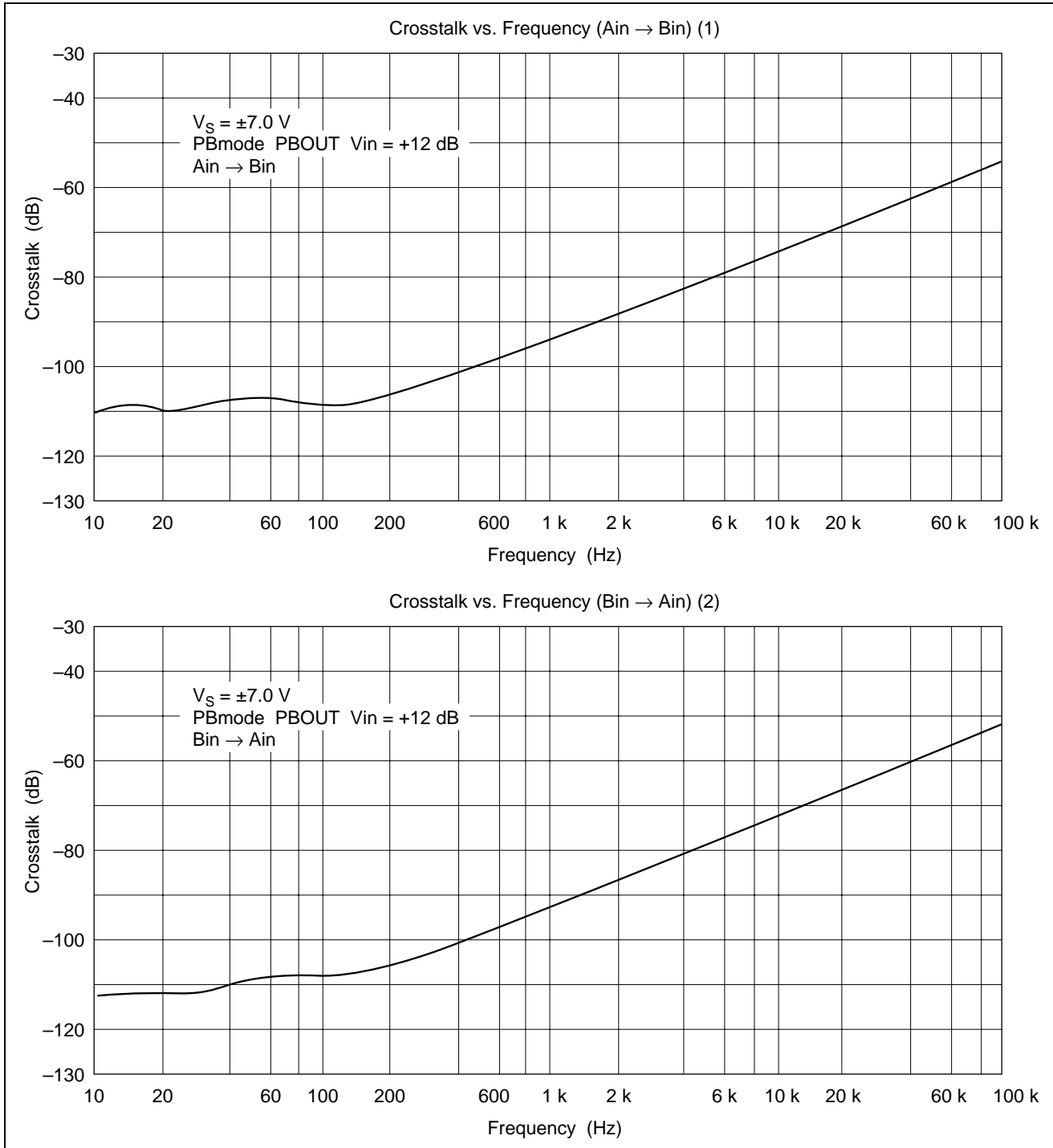

HA12203NT/HA12204NT

HA12203NT

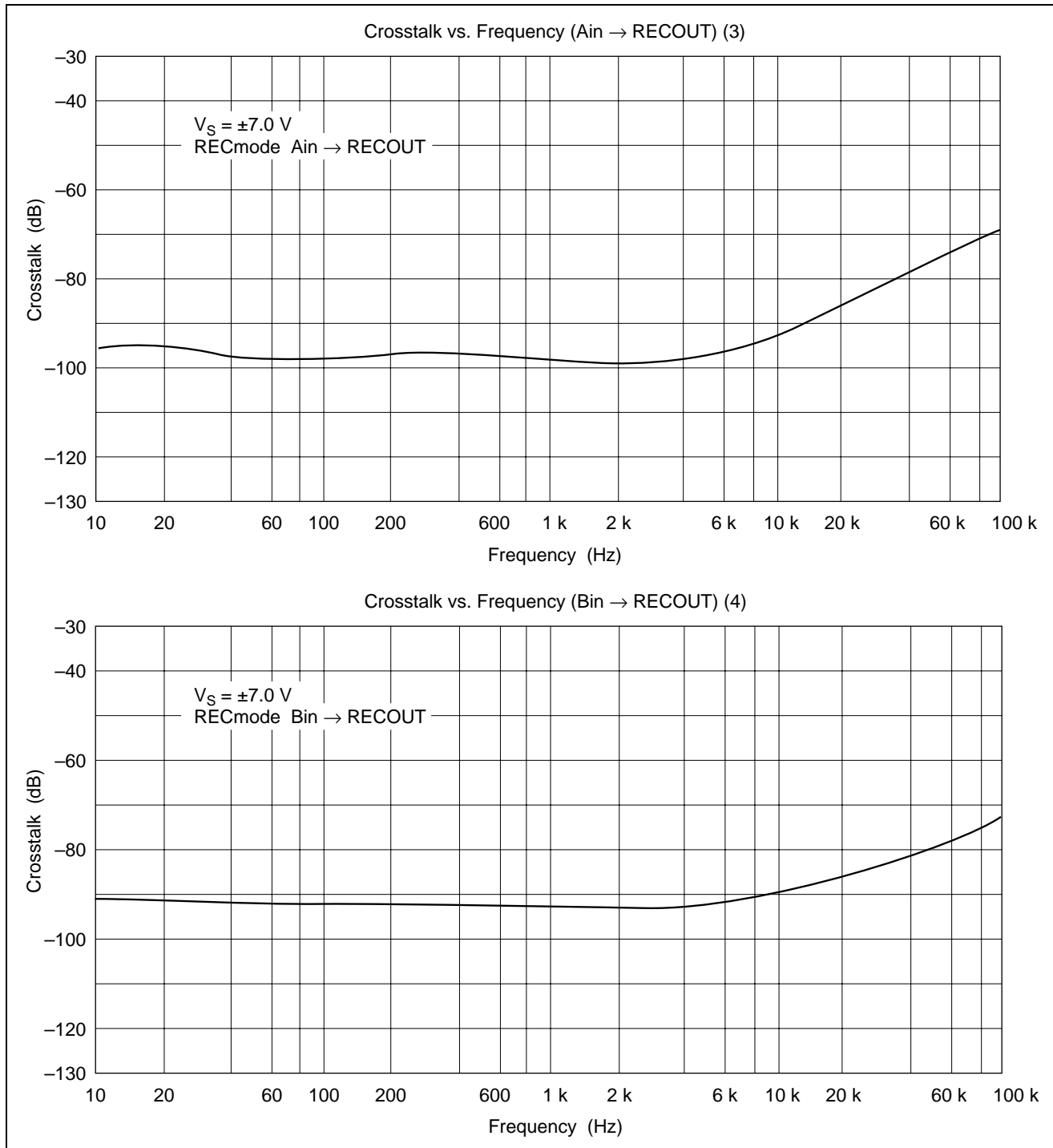

HA12203NT

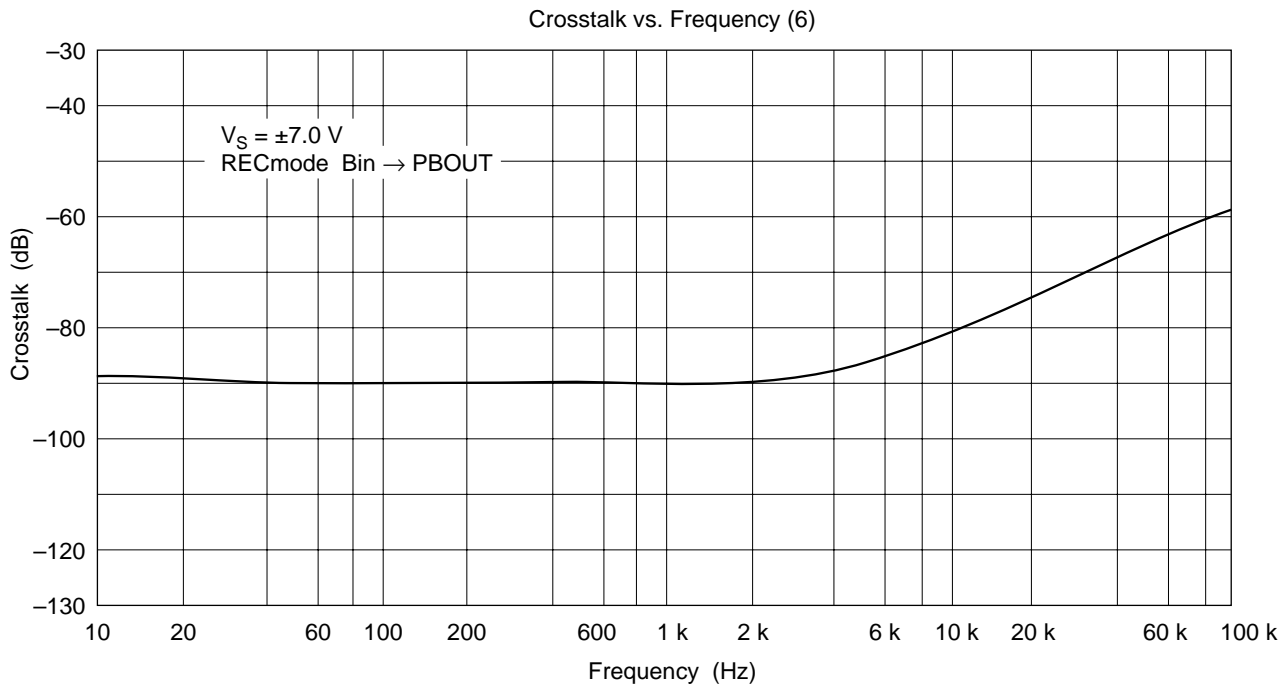
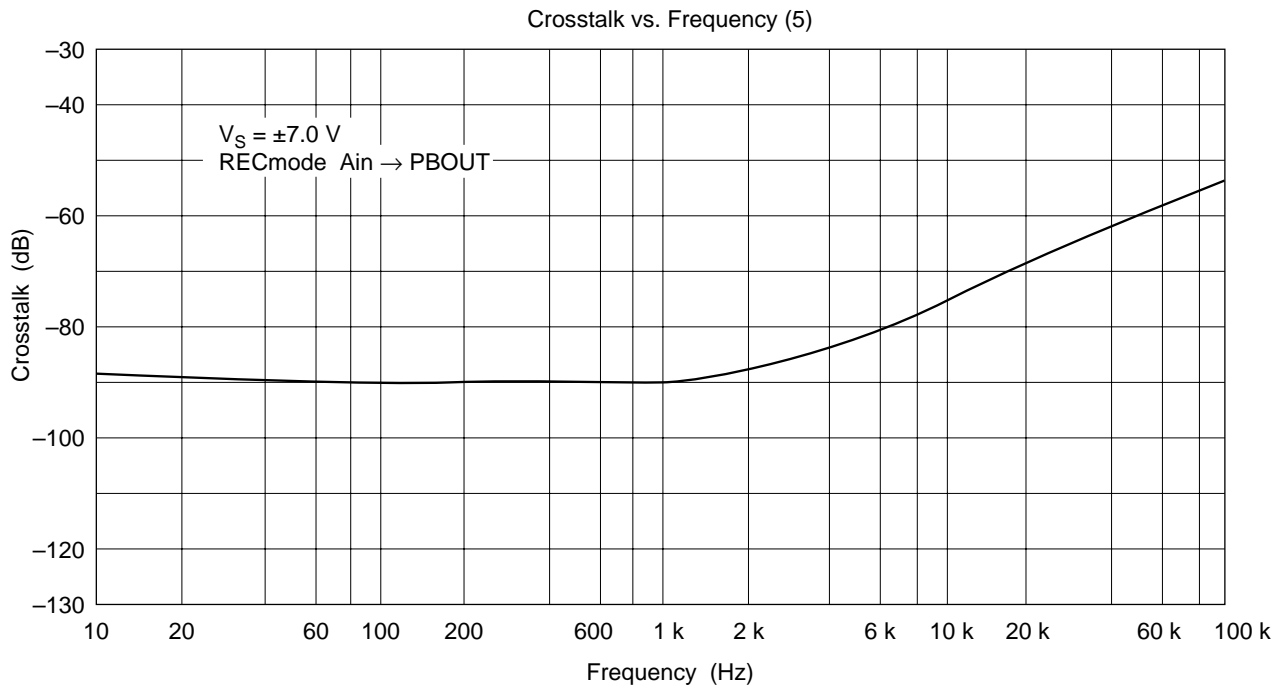

HA12203NT/HA12204NT

HA12203NT

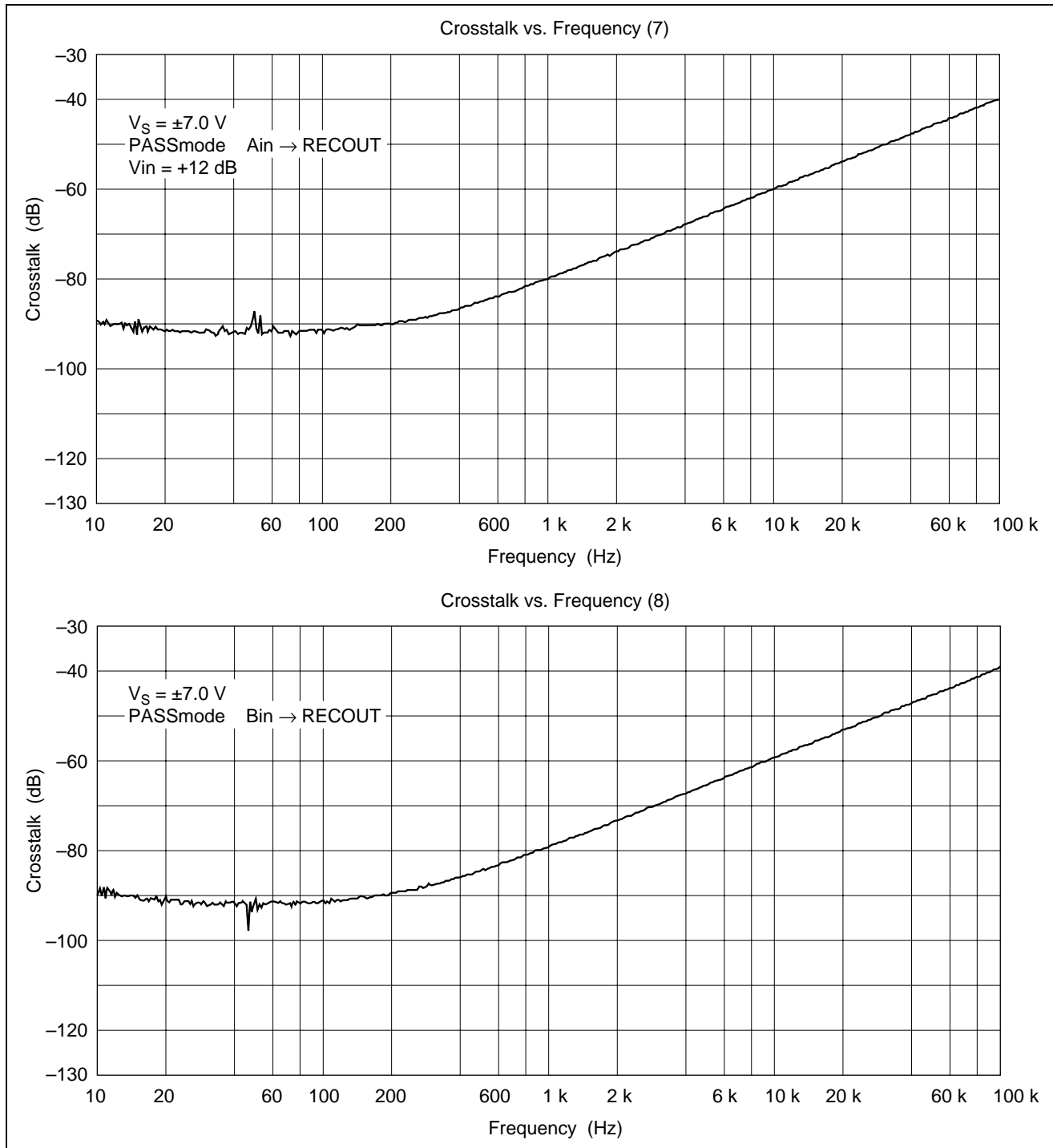

HA12203NT

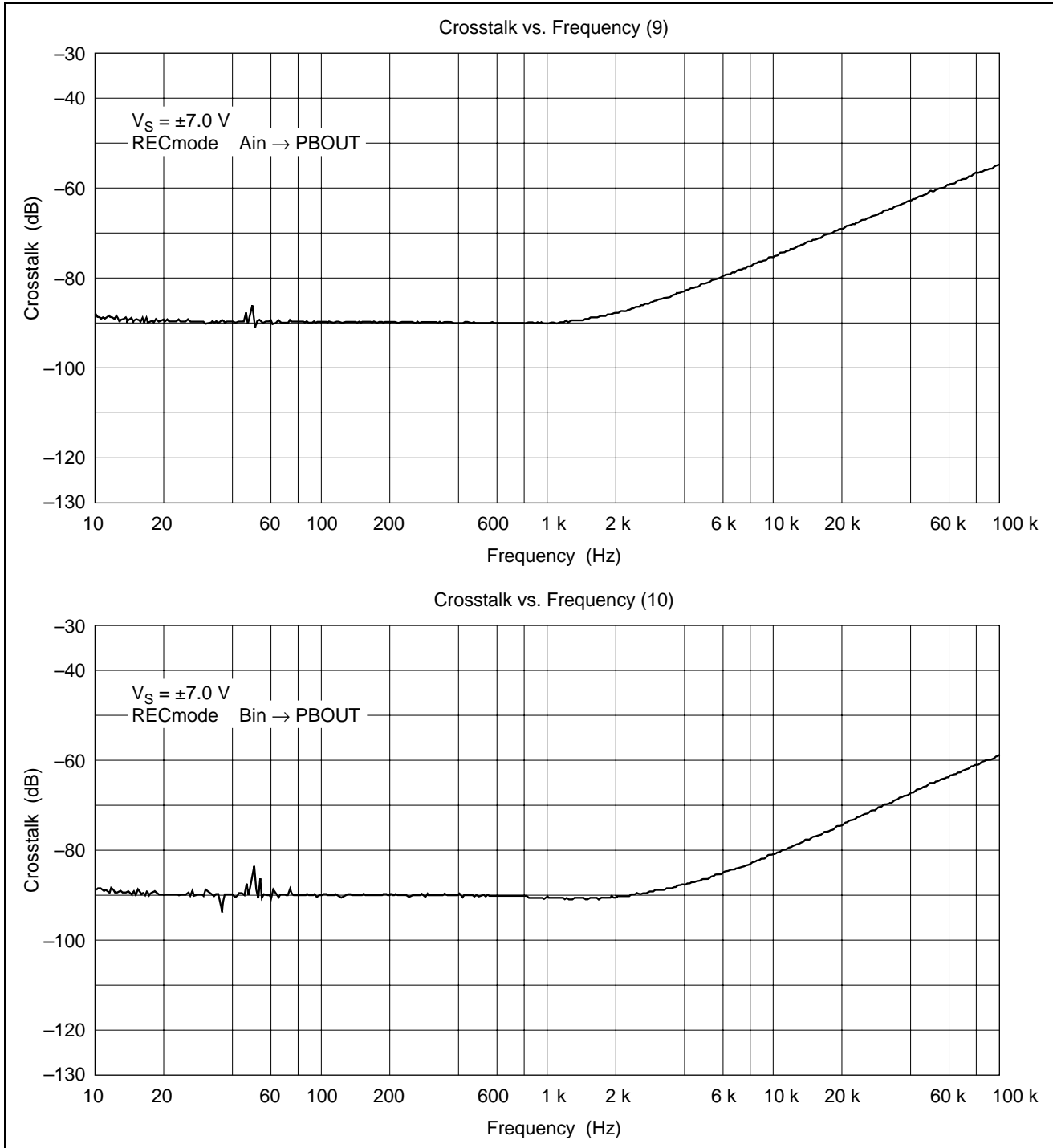

HA12203NT/HA12204NT

HA12203NT

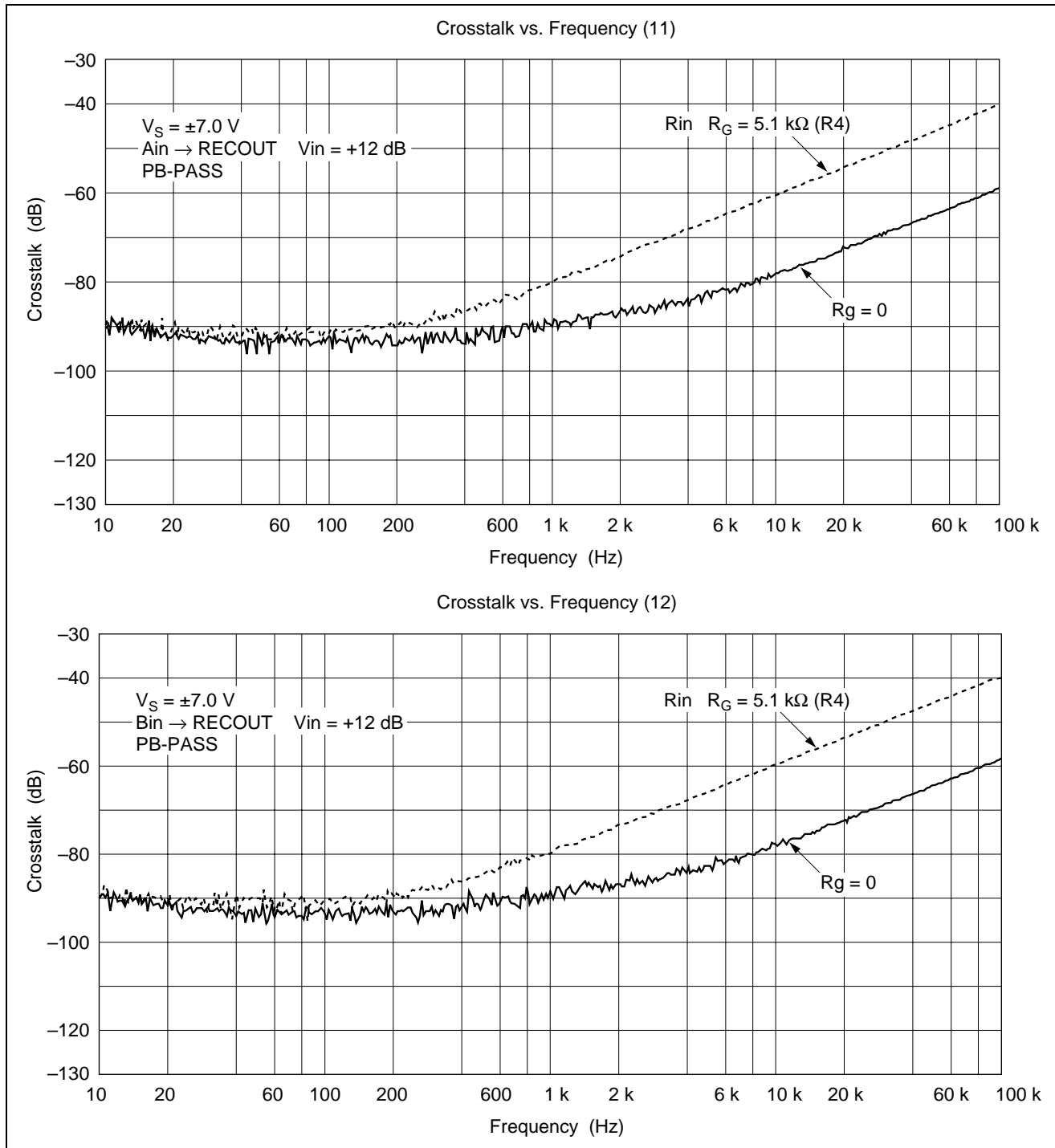

HA12203NT

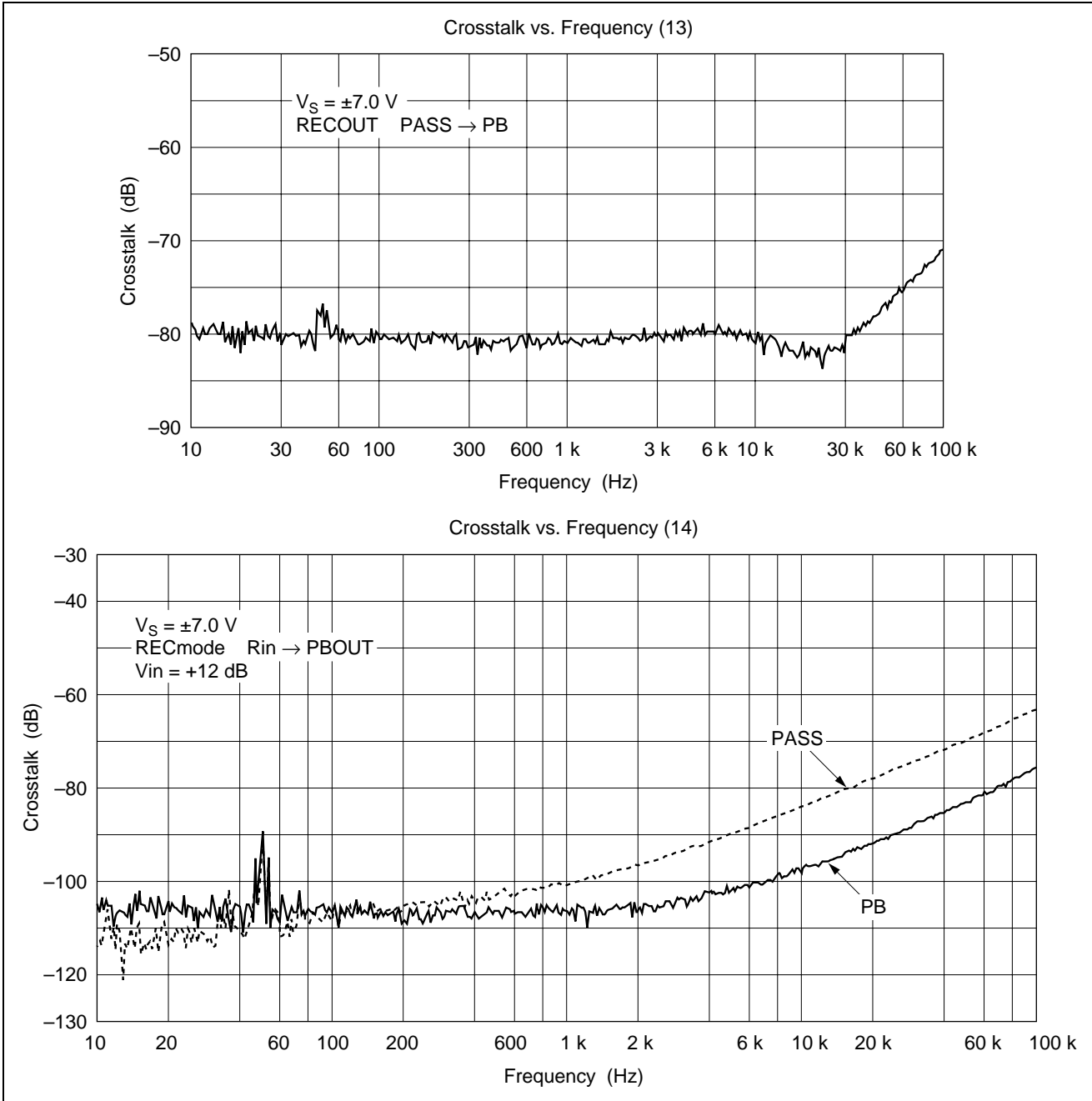

HA12203NT/HA12204NT

HA12203NT

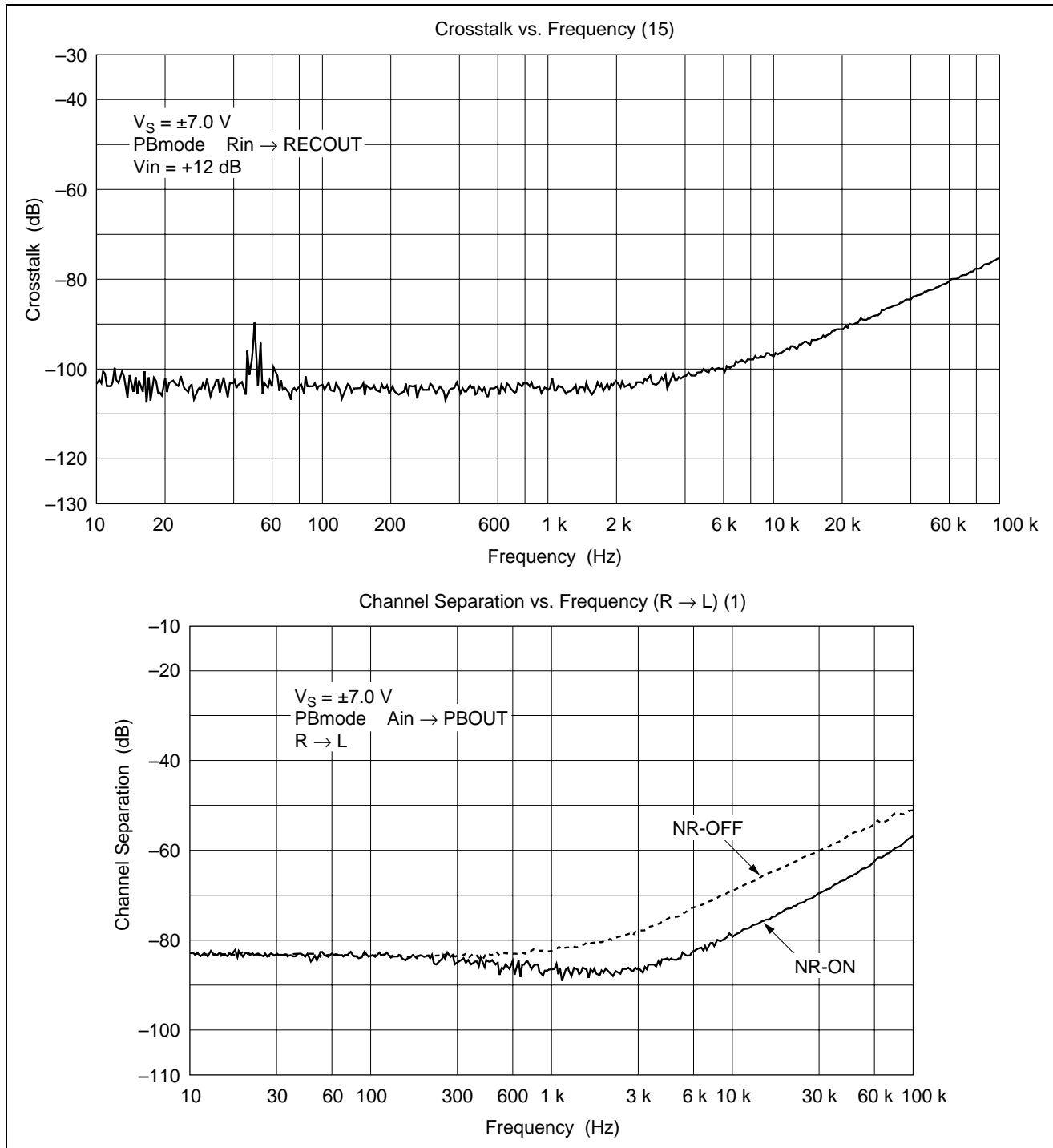

HA12203NT

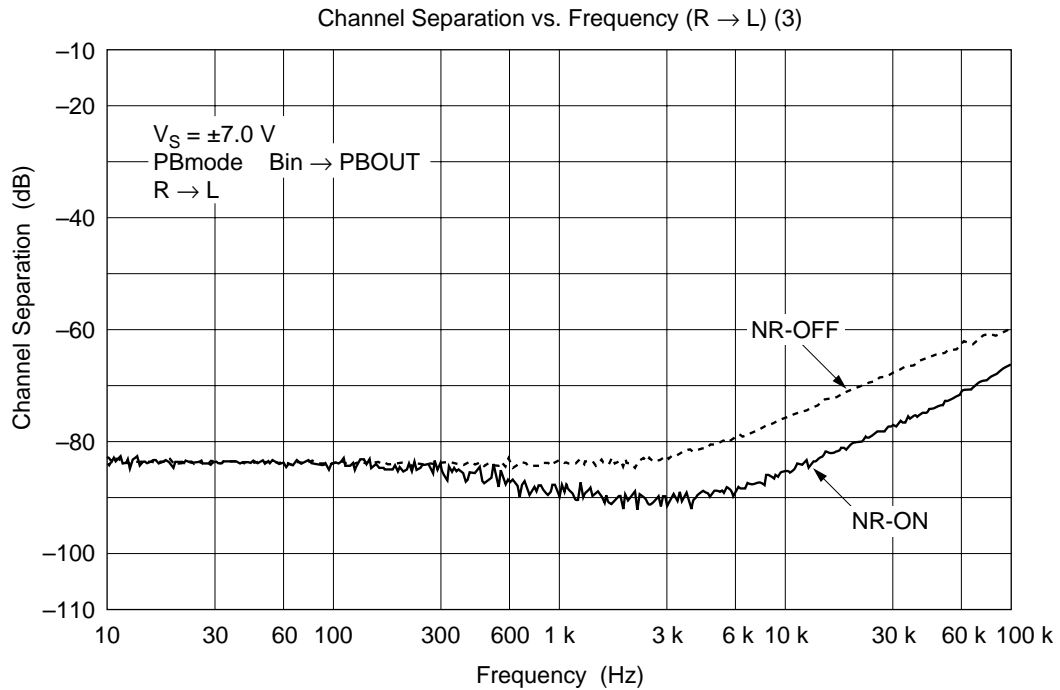
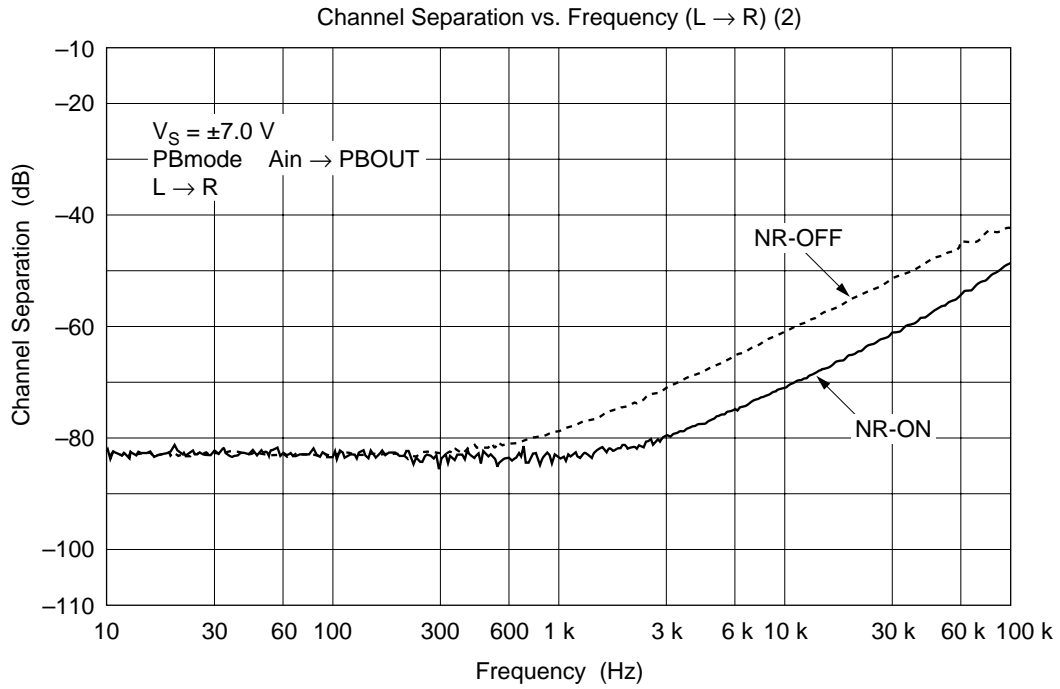

HA12203NT/HA12204NT

HA12203NT

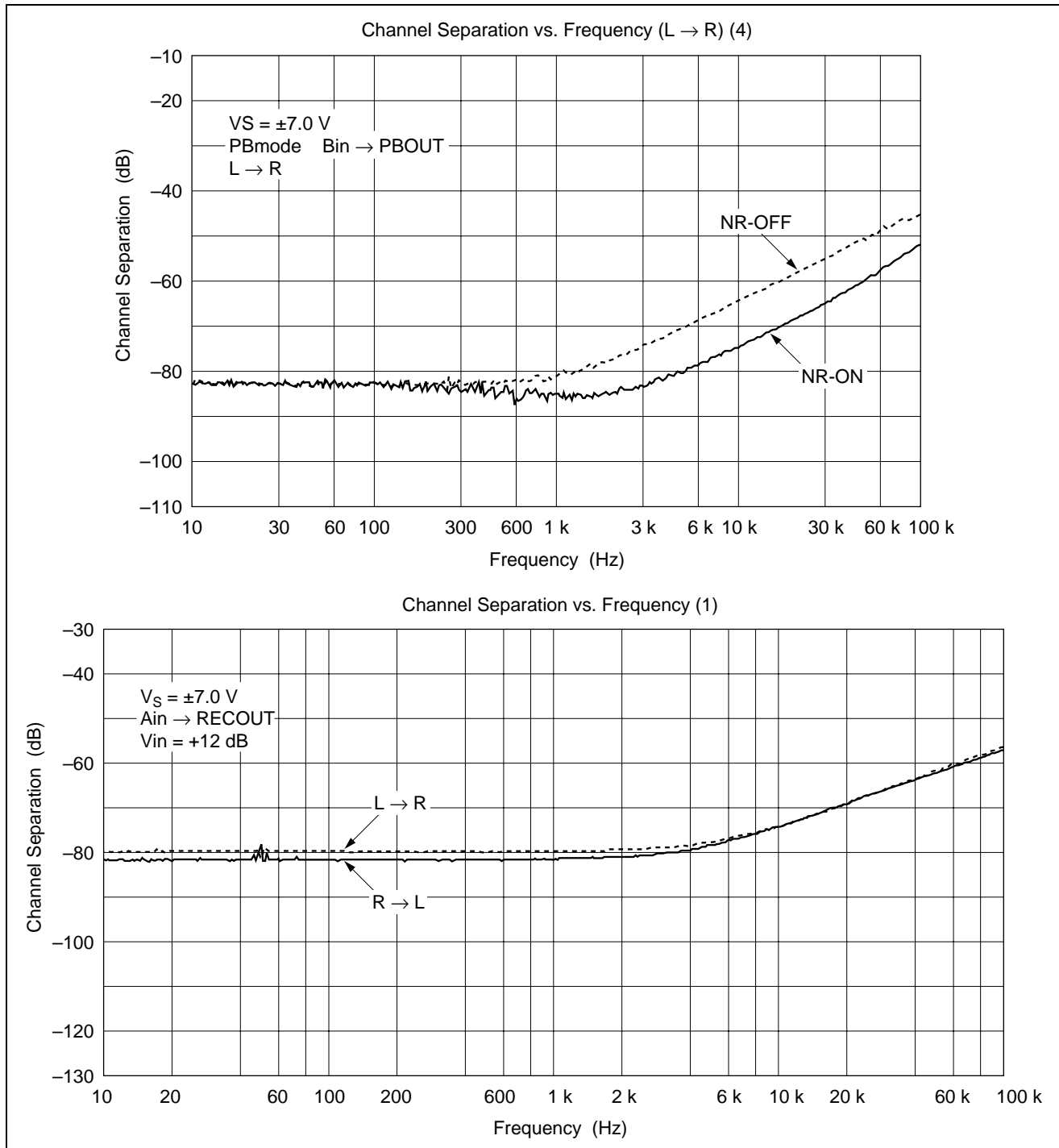

HA12203NT

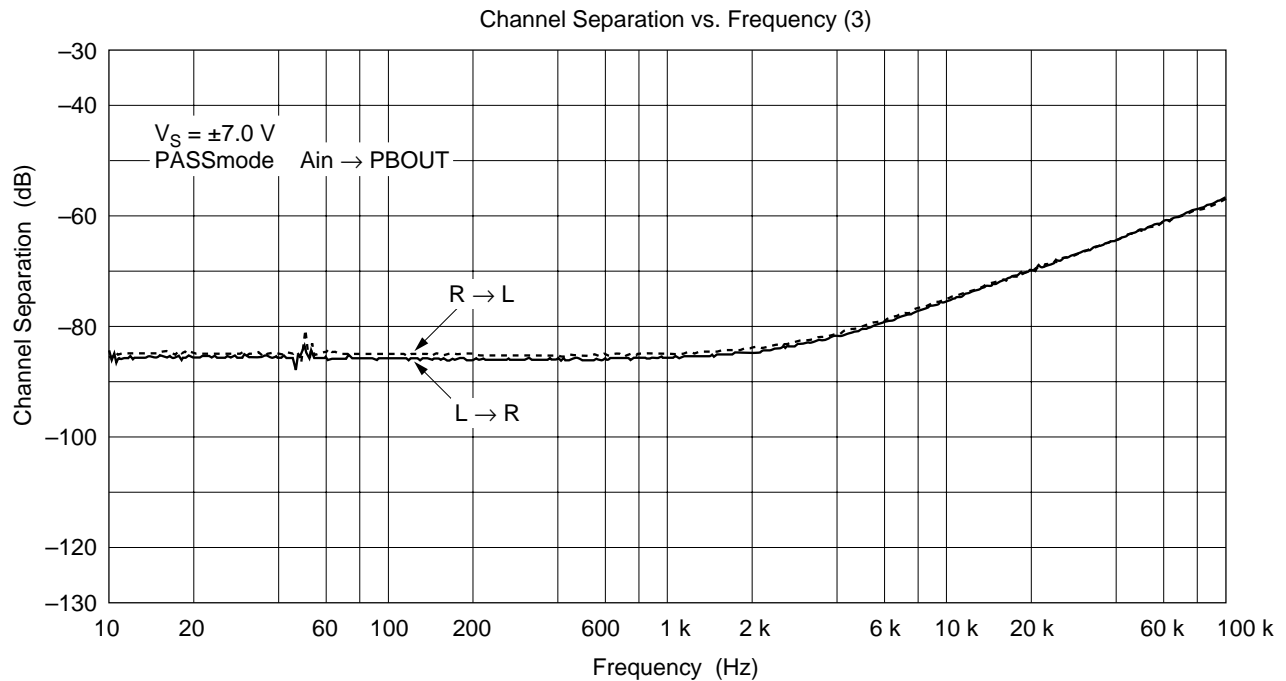
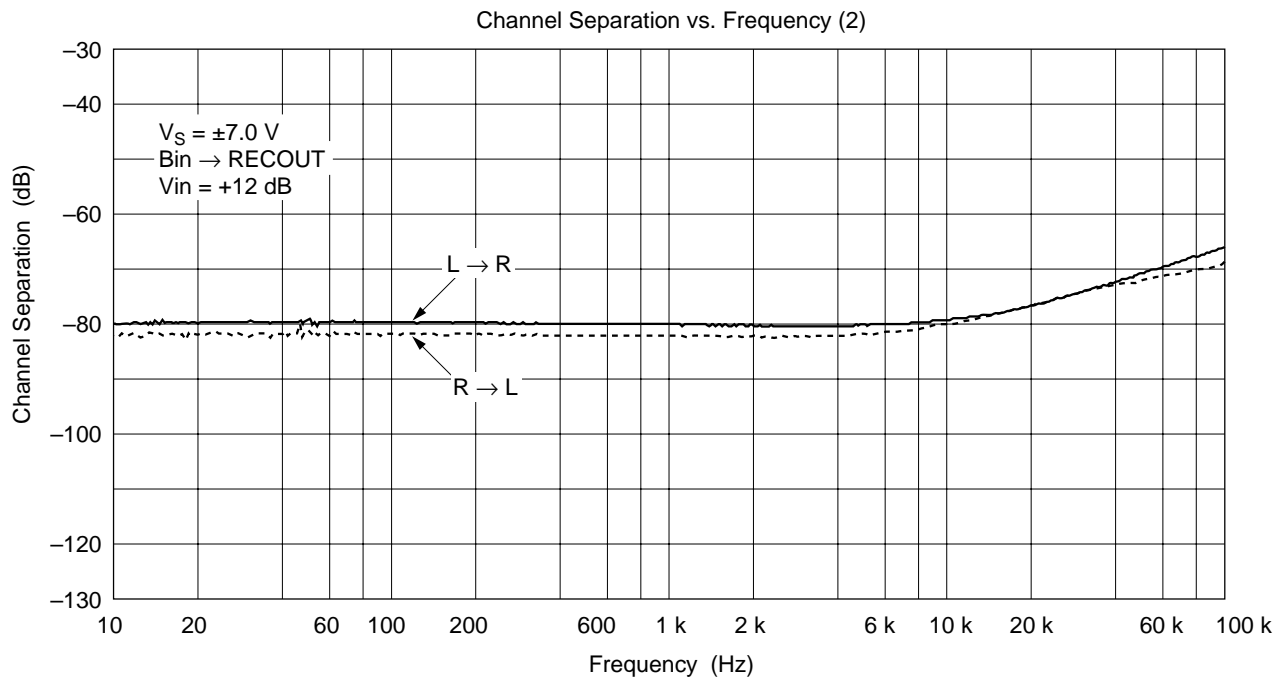

HA12203NT/HA12204NT

HA12203NT

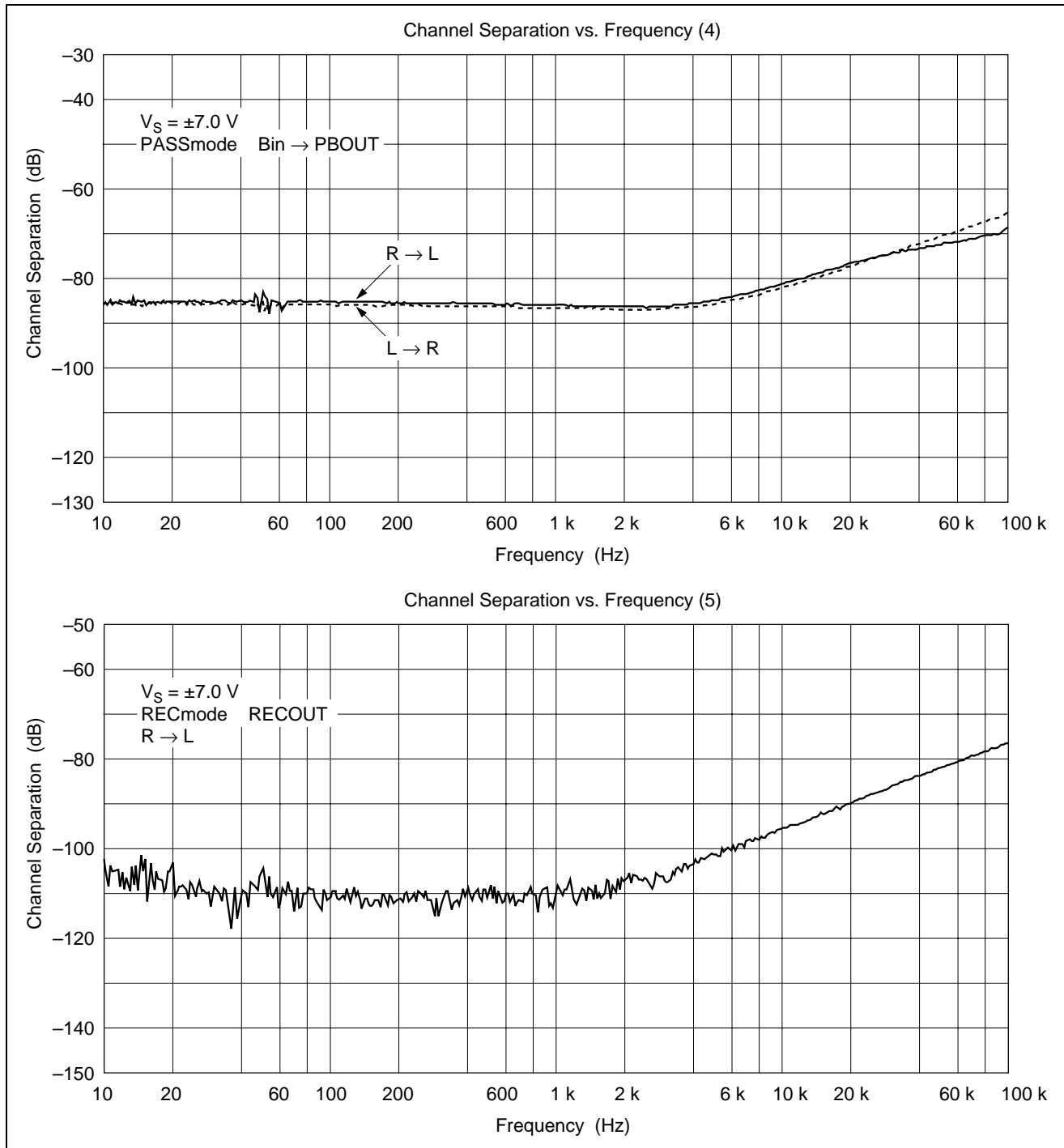

HA12203NT

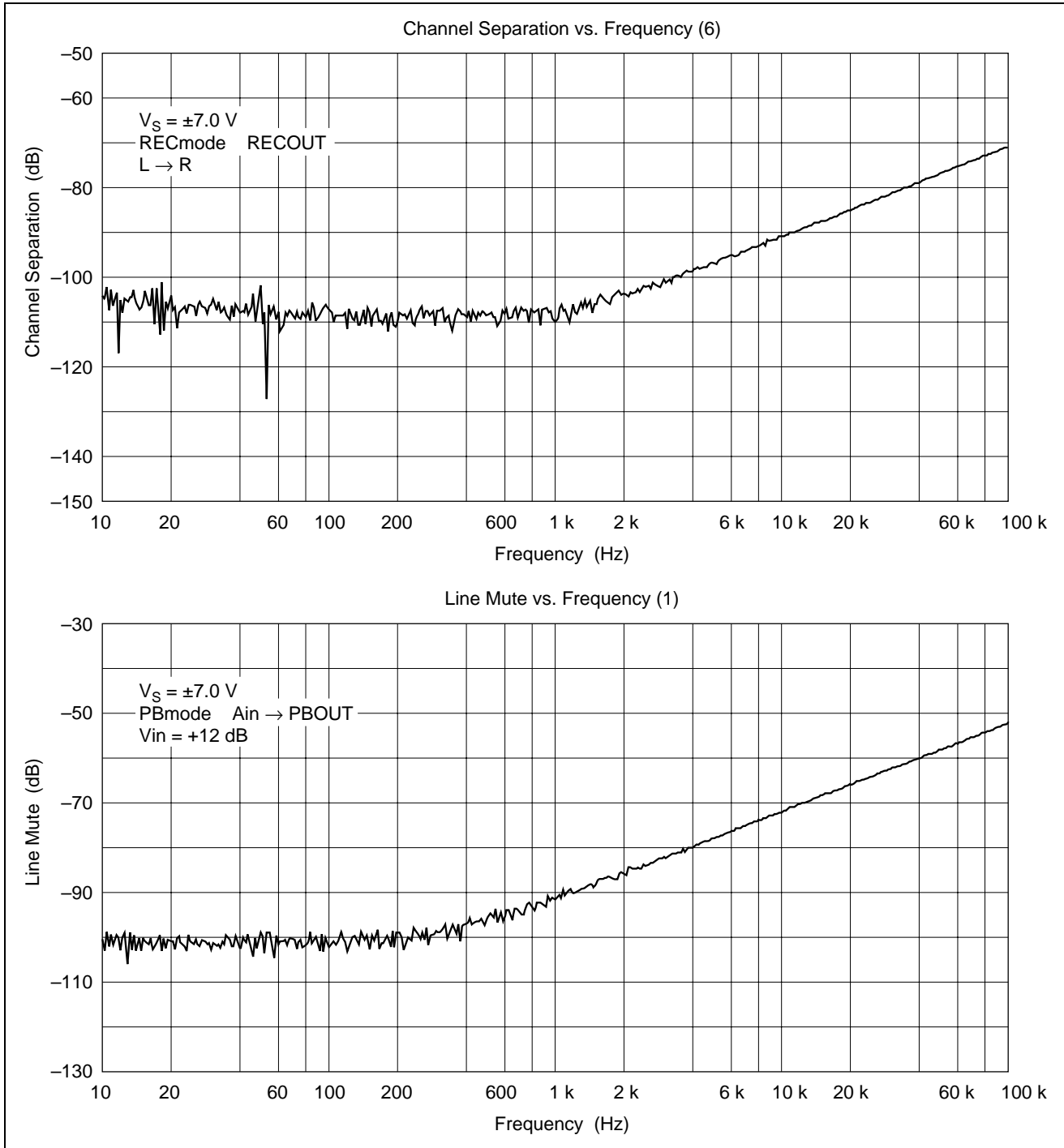

HA12203NT/HA12204NT

HA12203NT

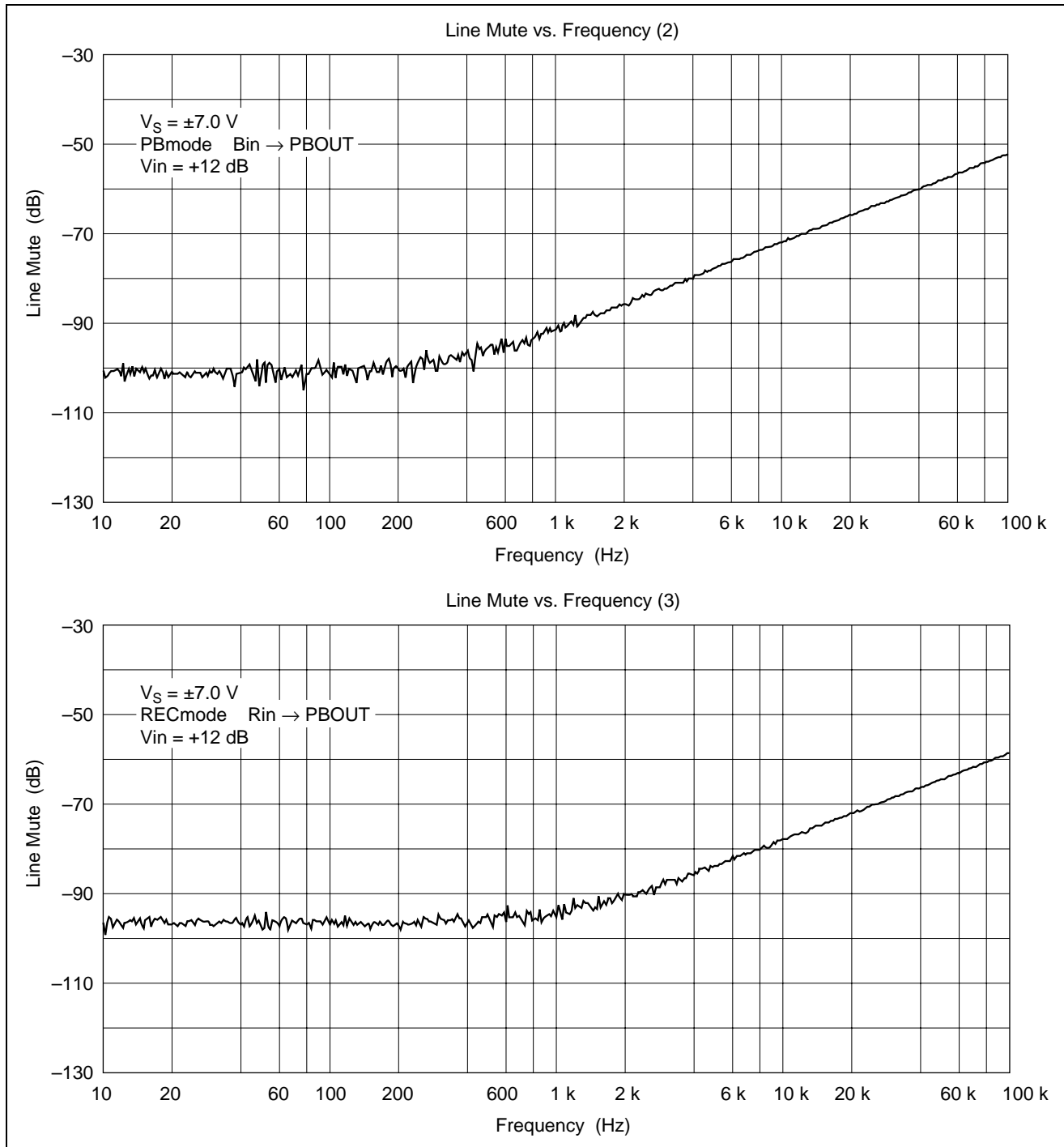

HA12203NT

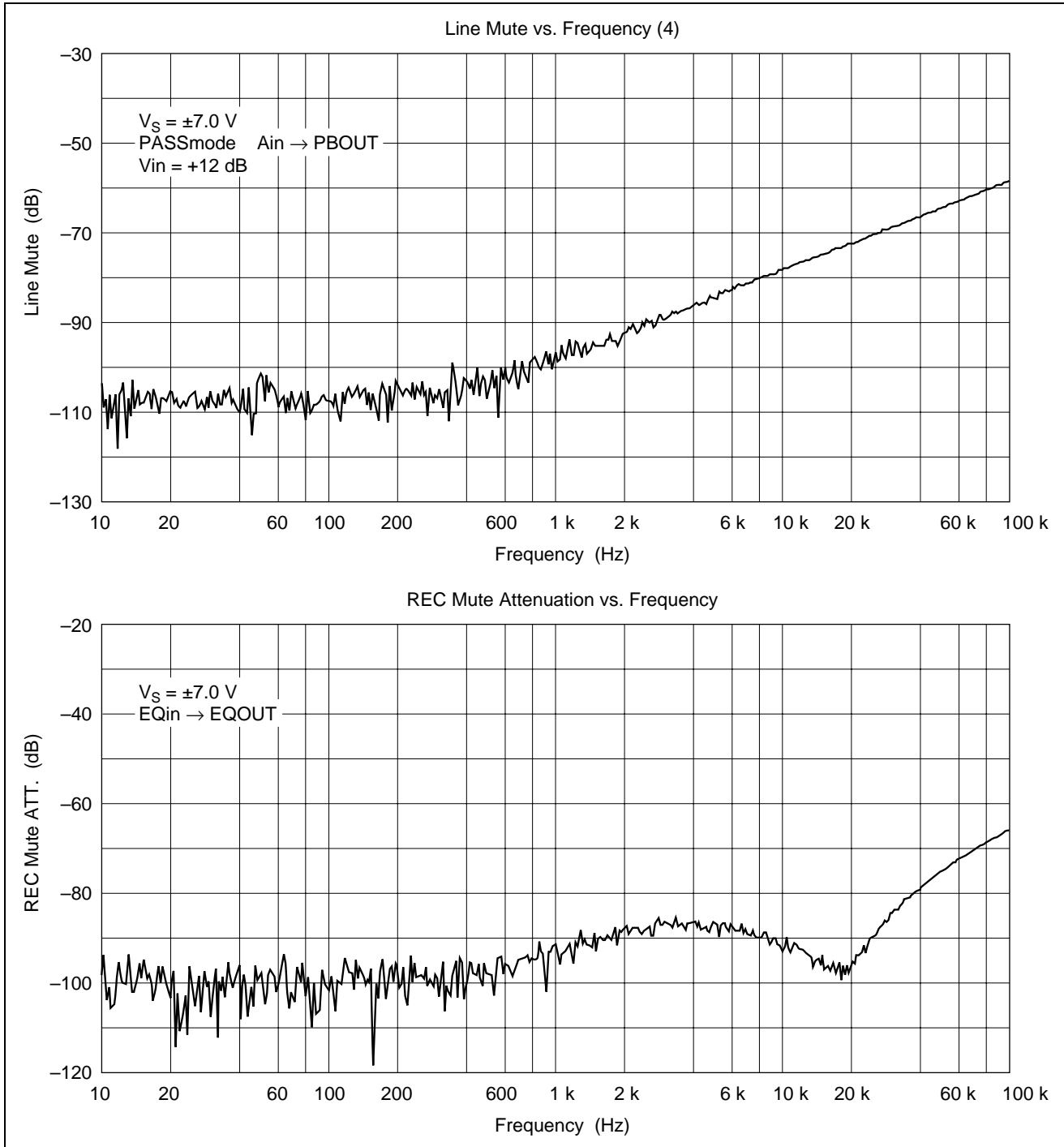

HA12203NT/HA12204NT

HA12203NT

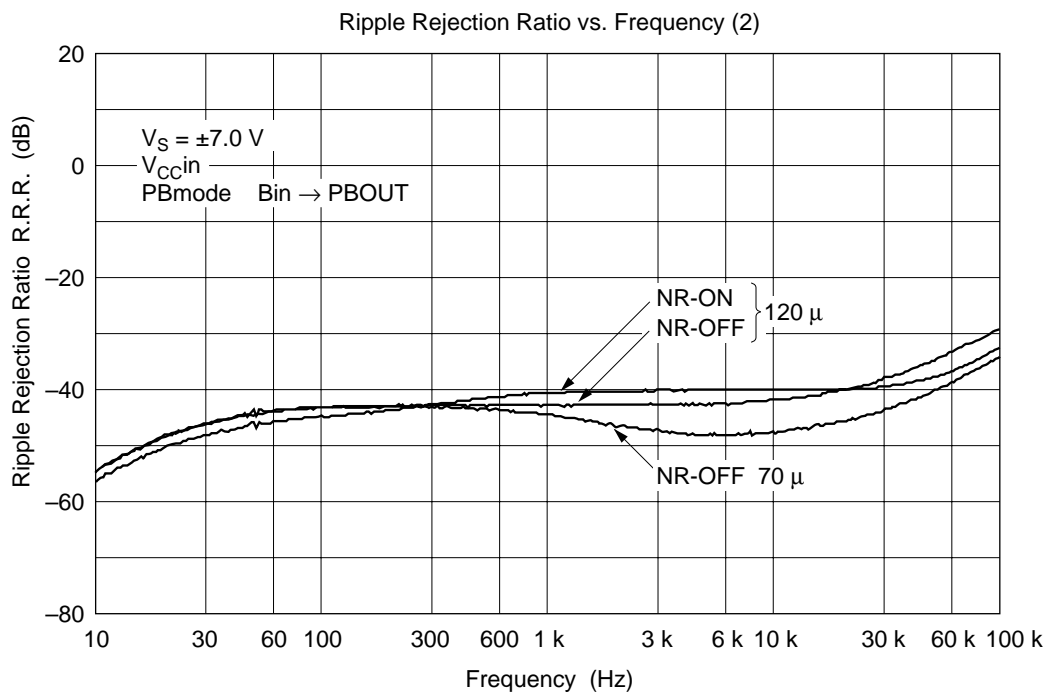
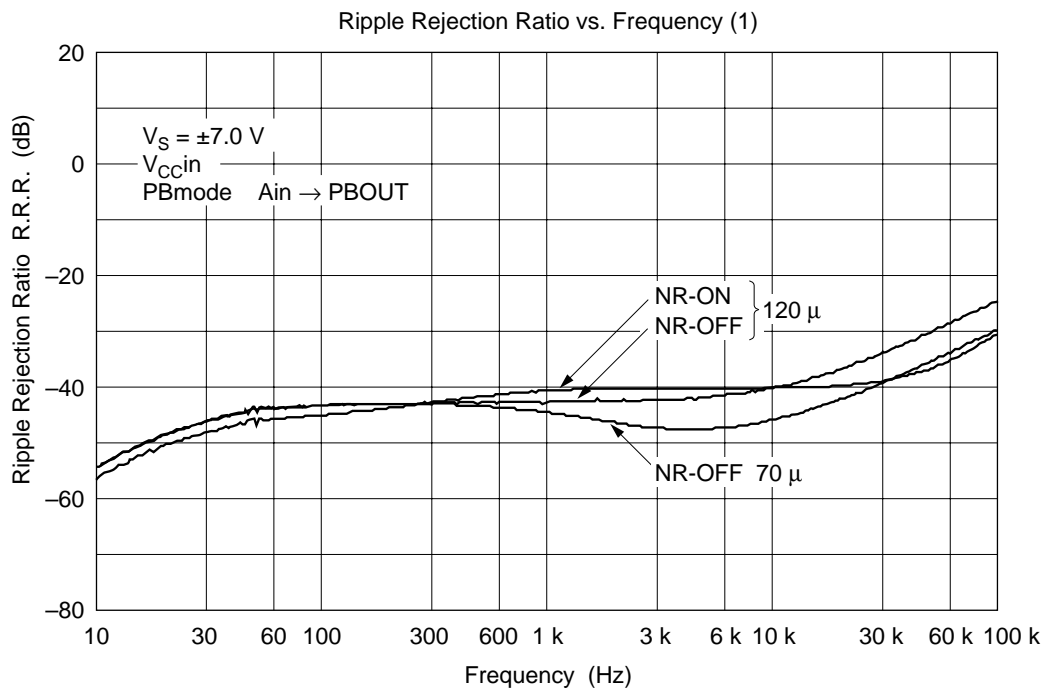

HA12203NT

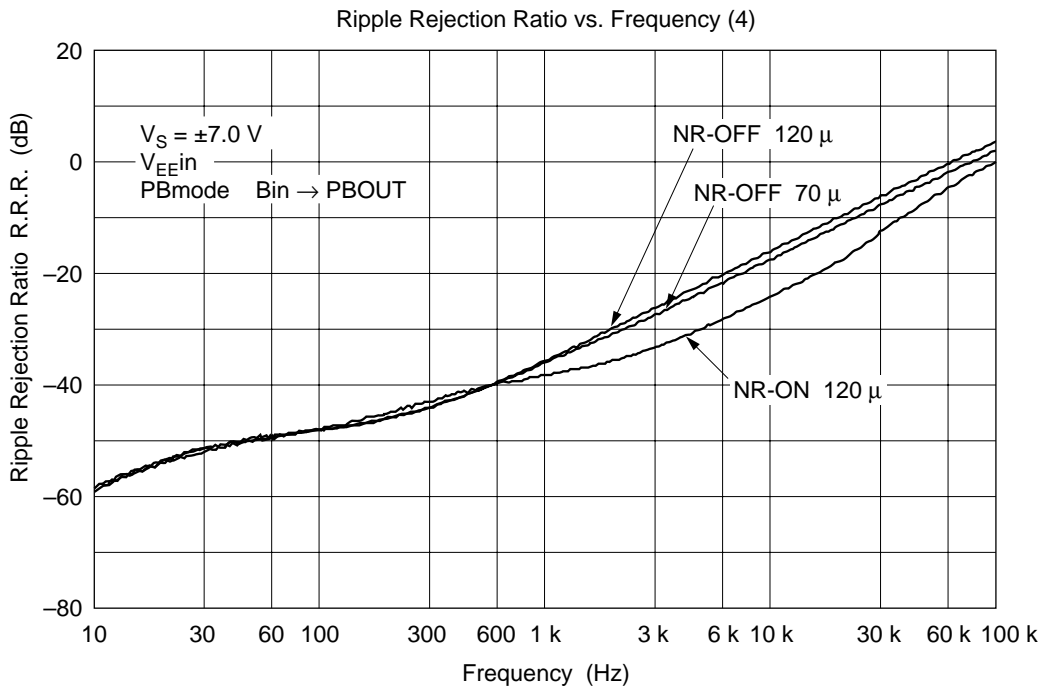
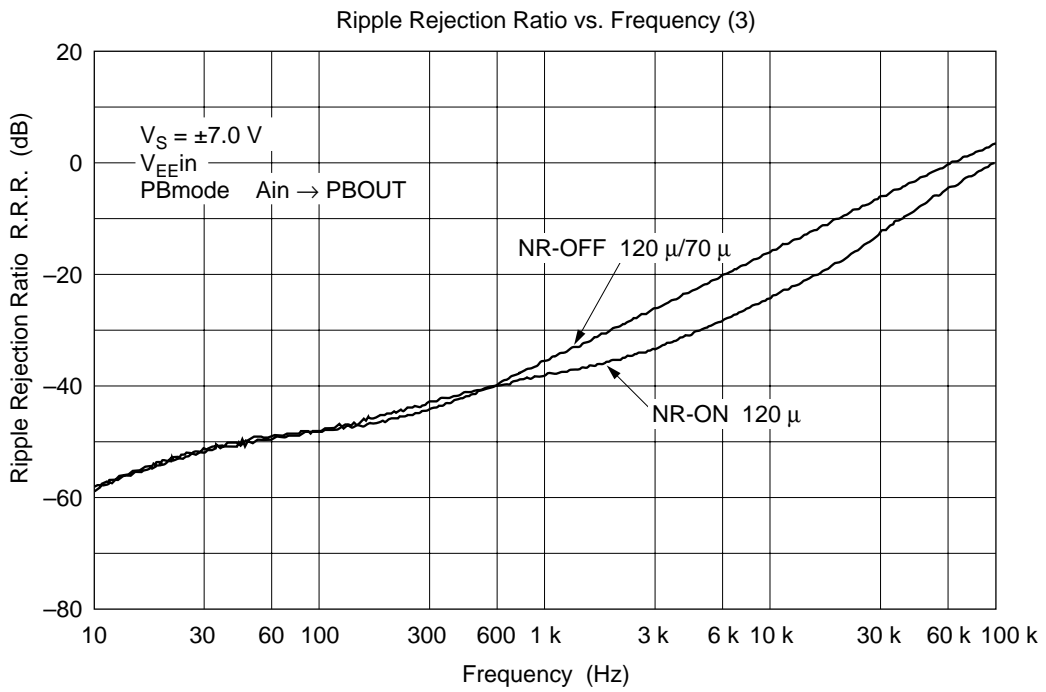

HA12203NT/HA12204NT

HA12203NT

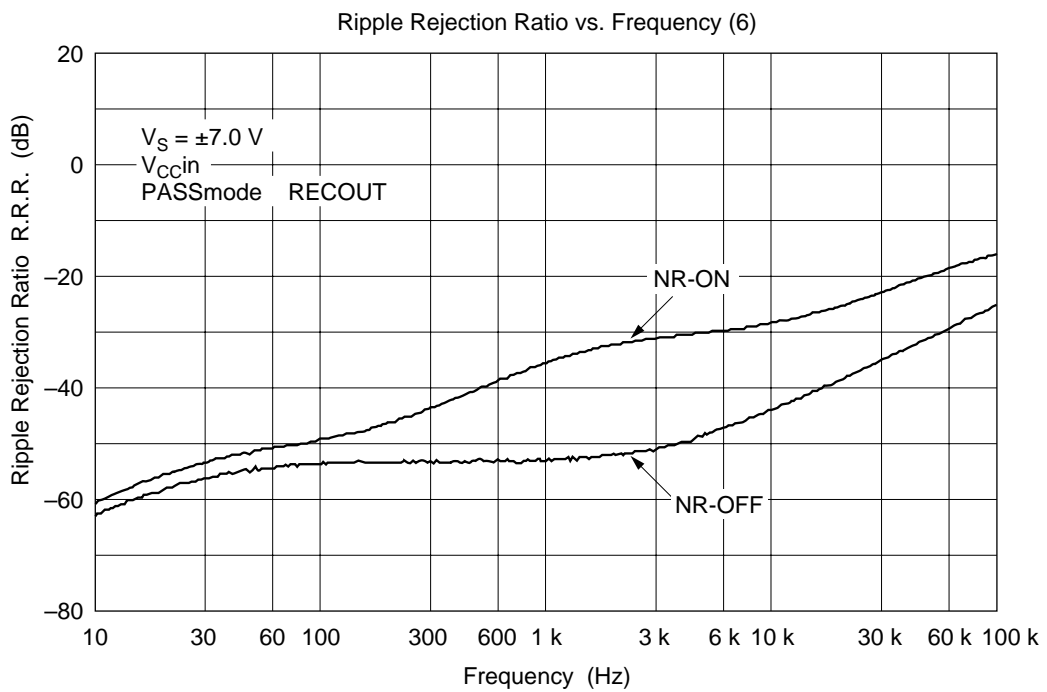
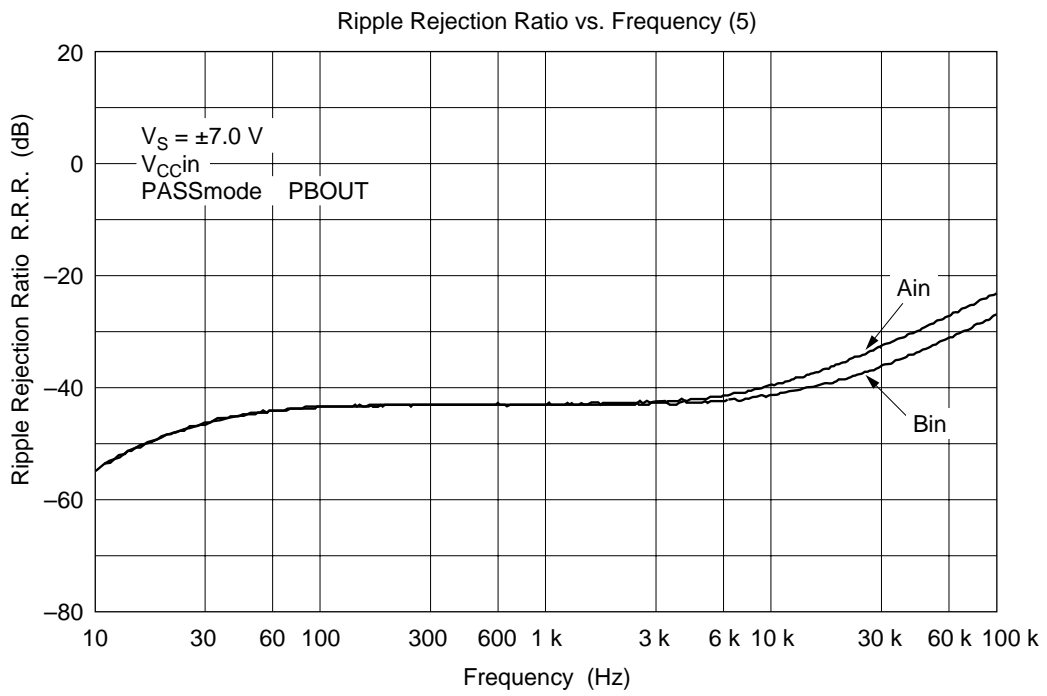

HA12203NT

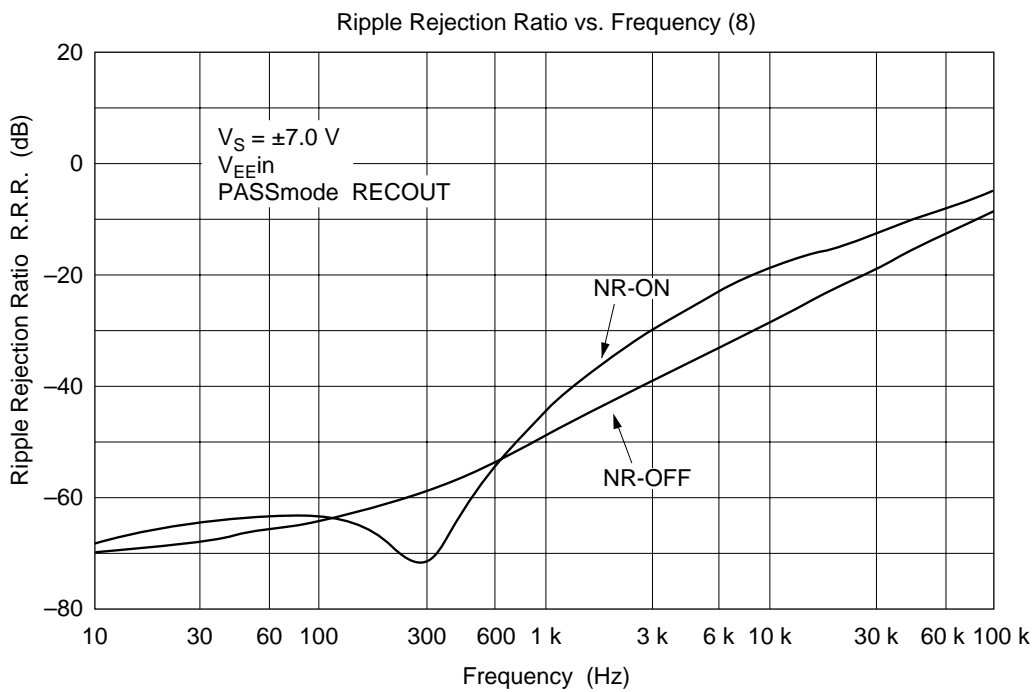
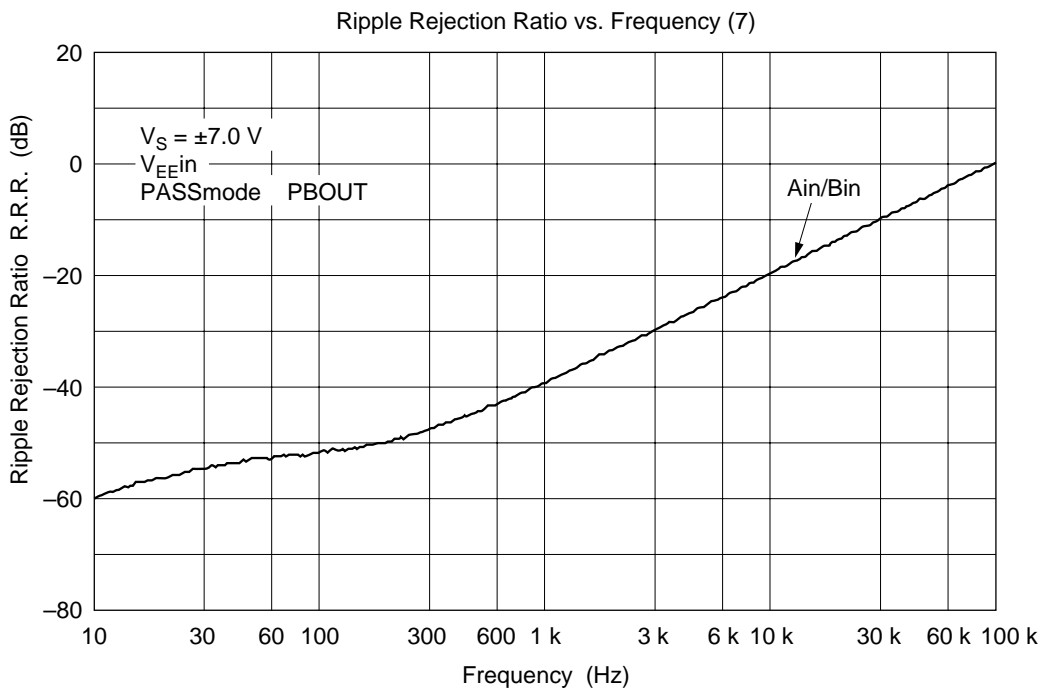

HA12203NT/HA12204NT

HA12203NT

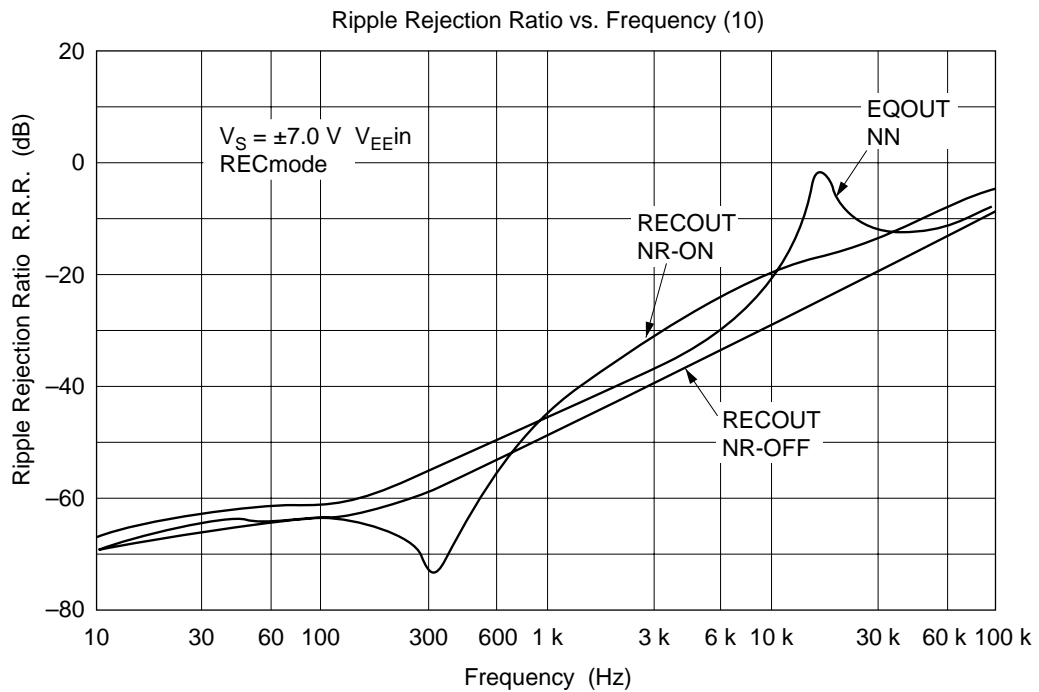
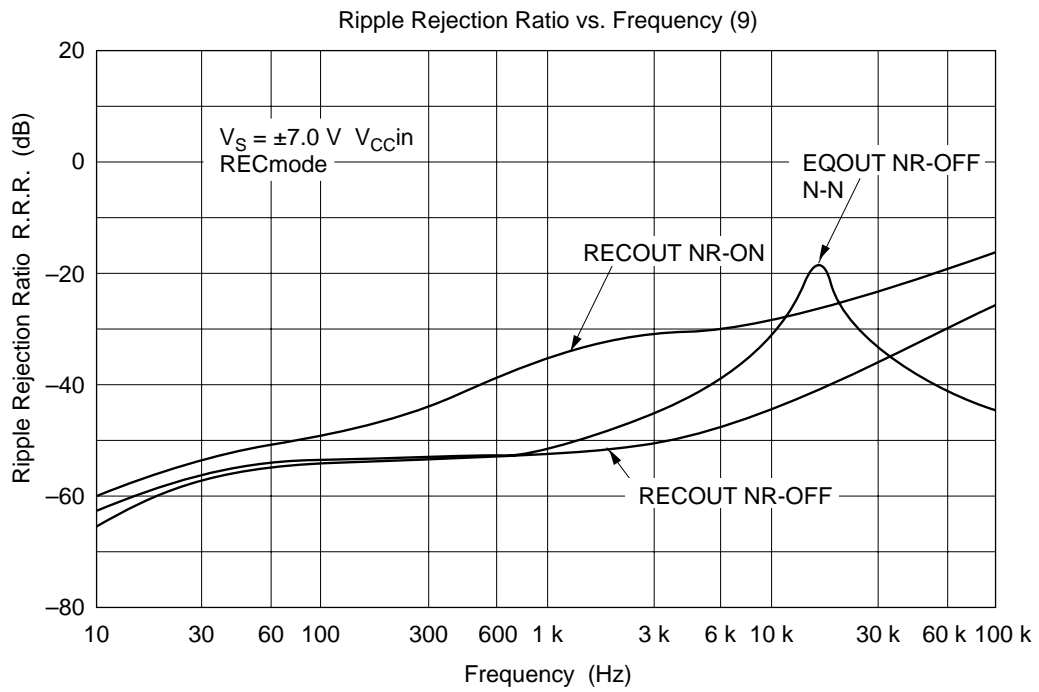

HA12203NT

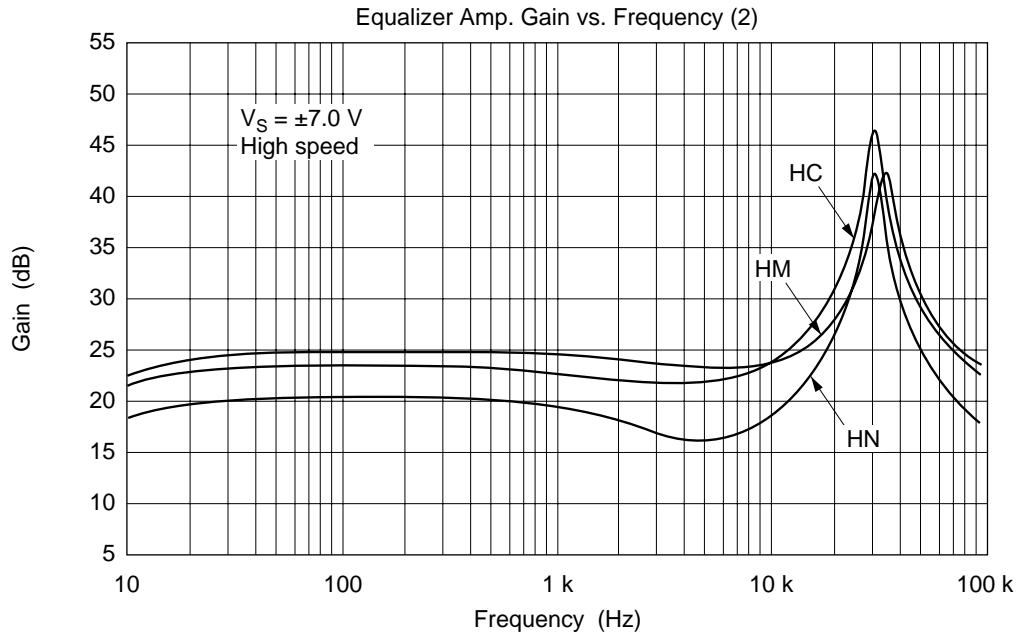
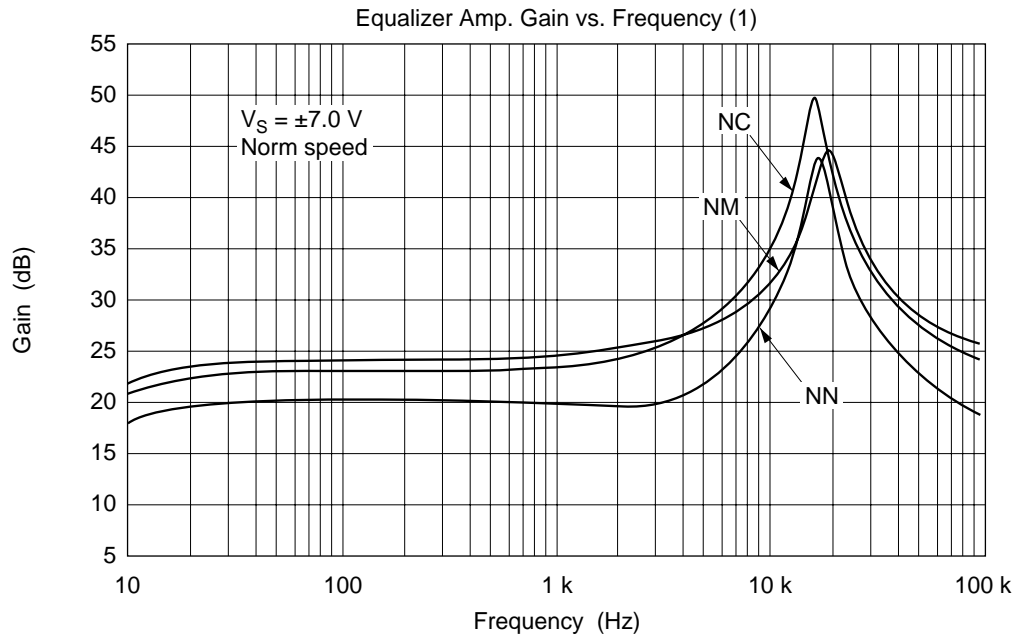

HA12203NT/HA12204NT

HA12203NT

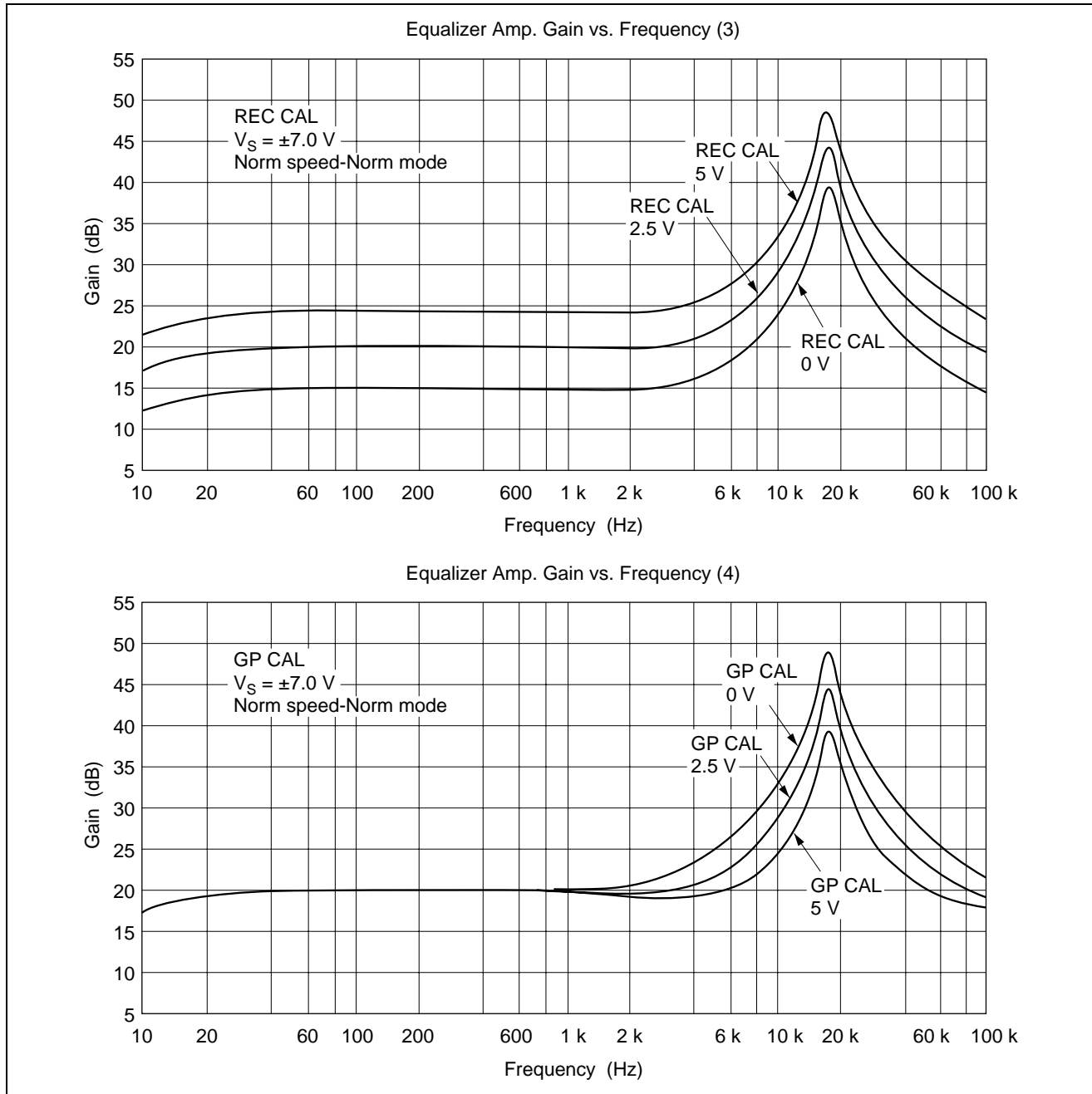

HA12203NT

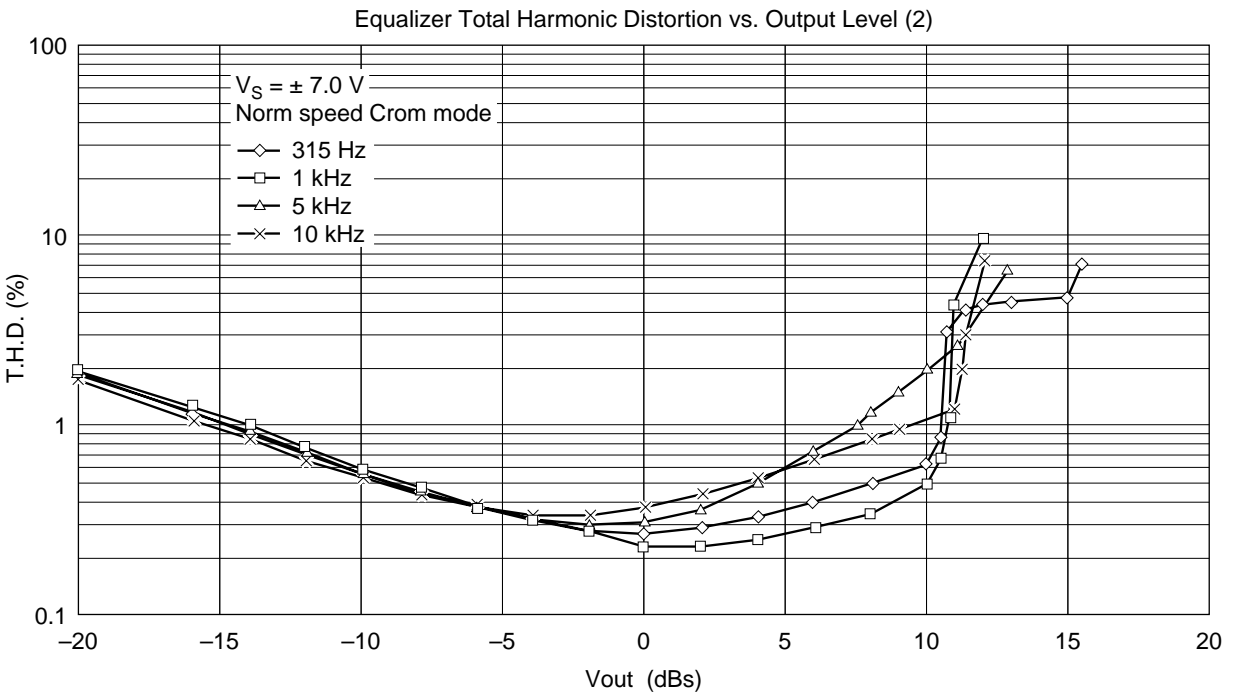
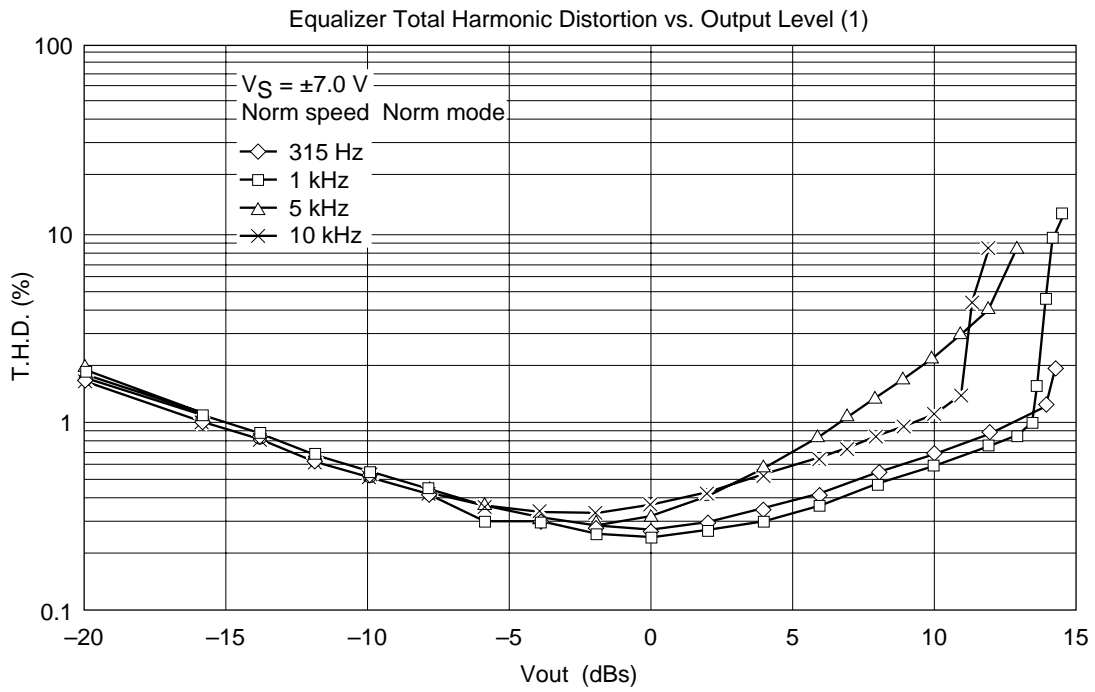

HA12203NT

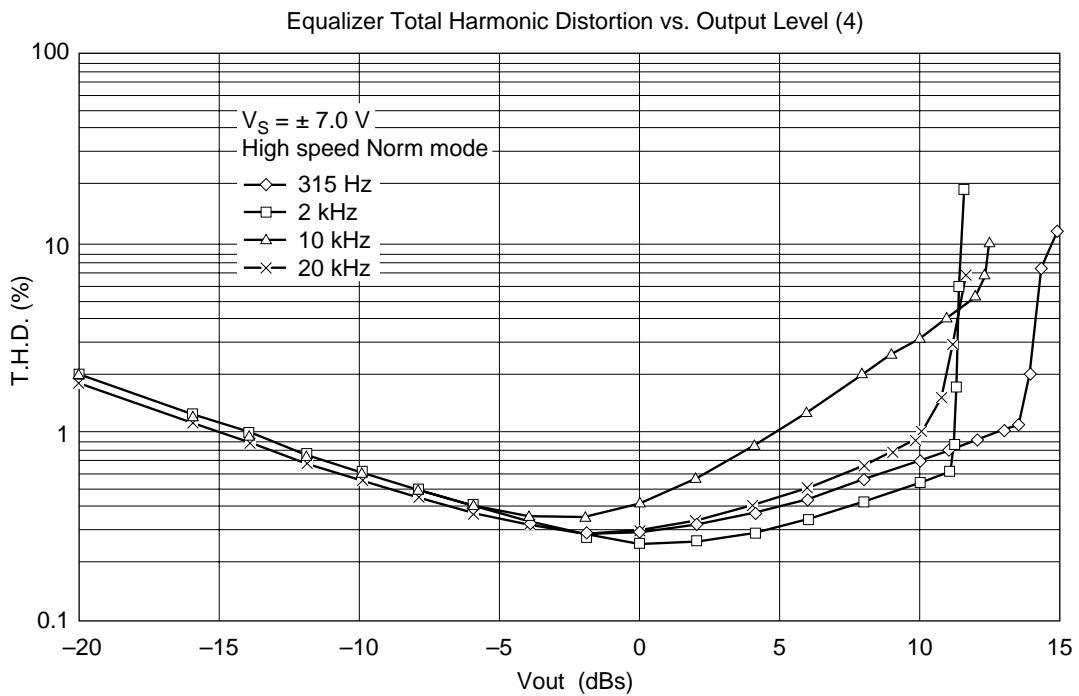
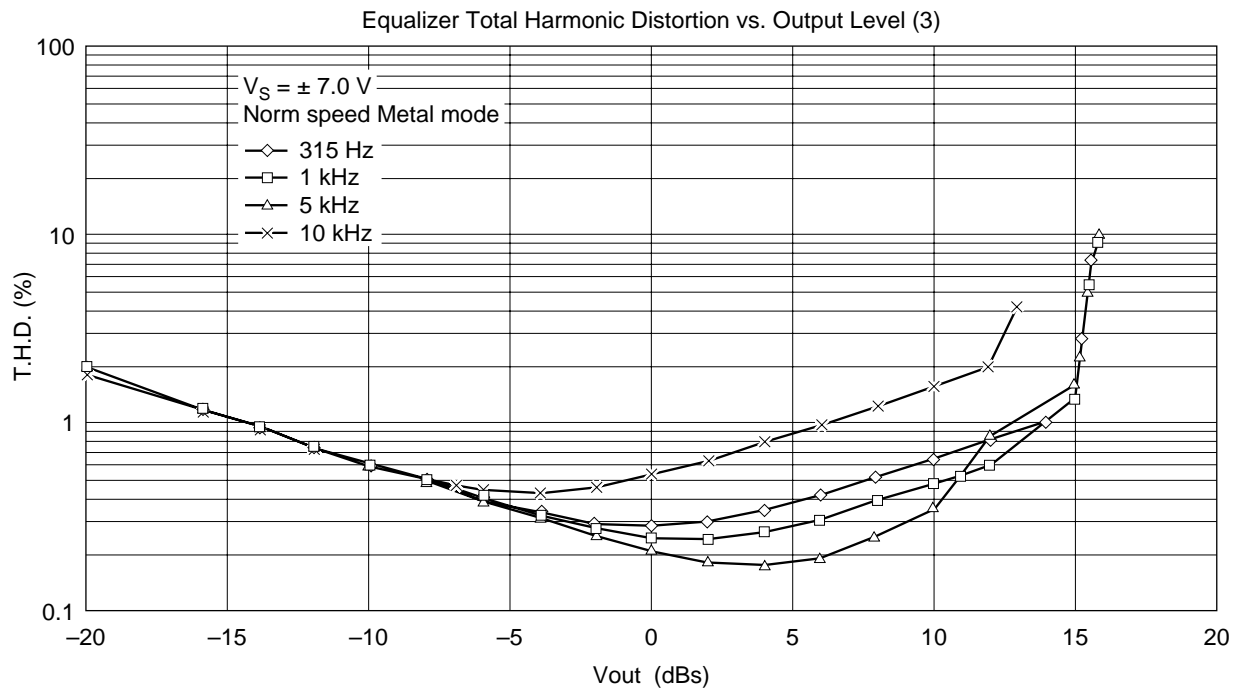

HA12203NT

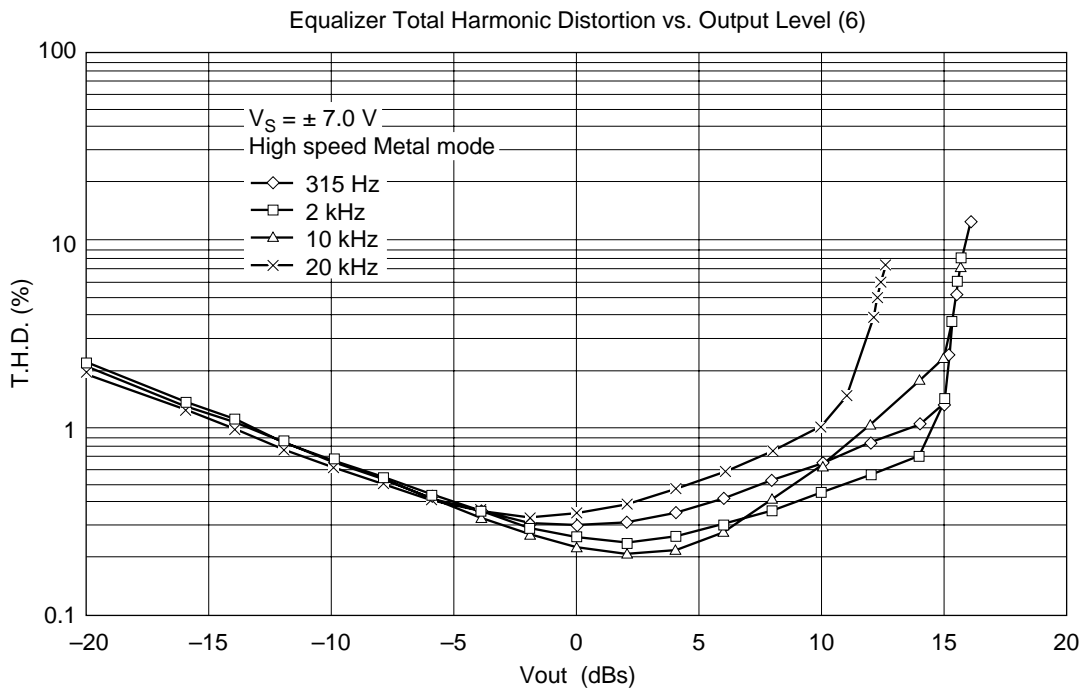
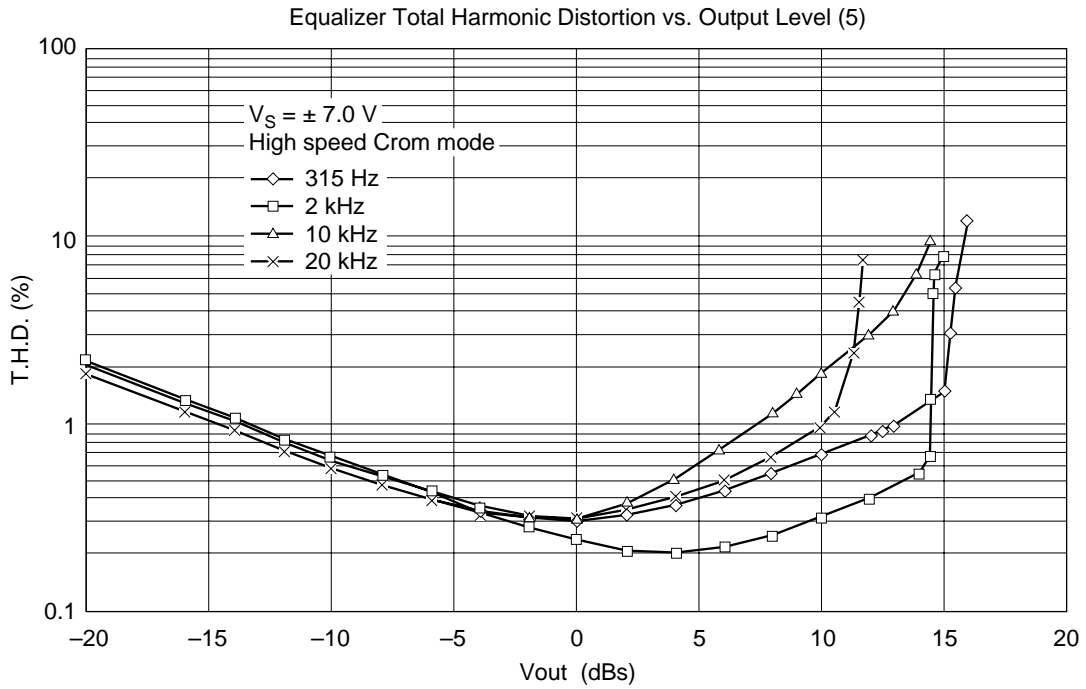

HA12203NT

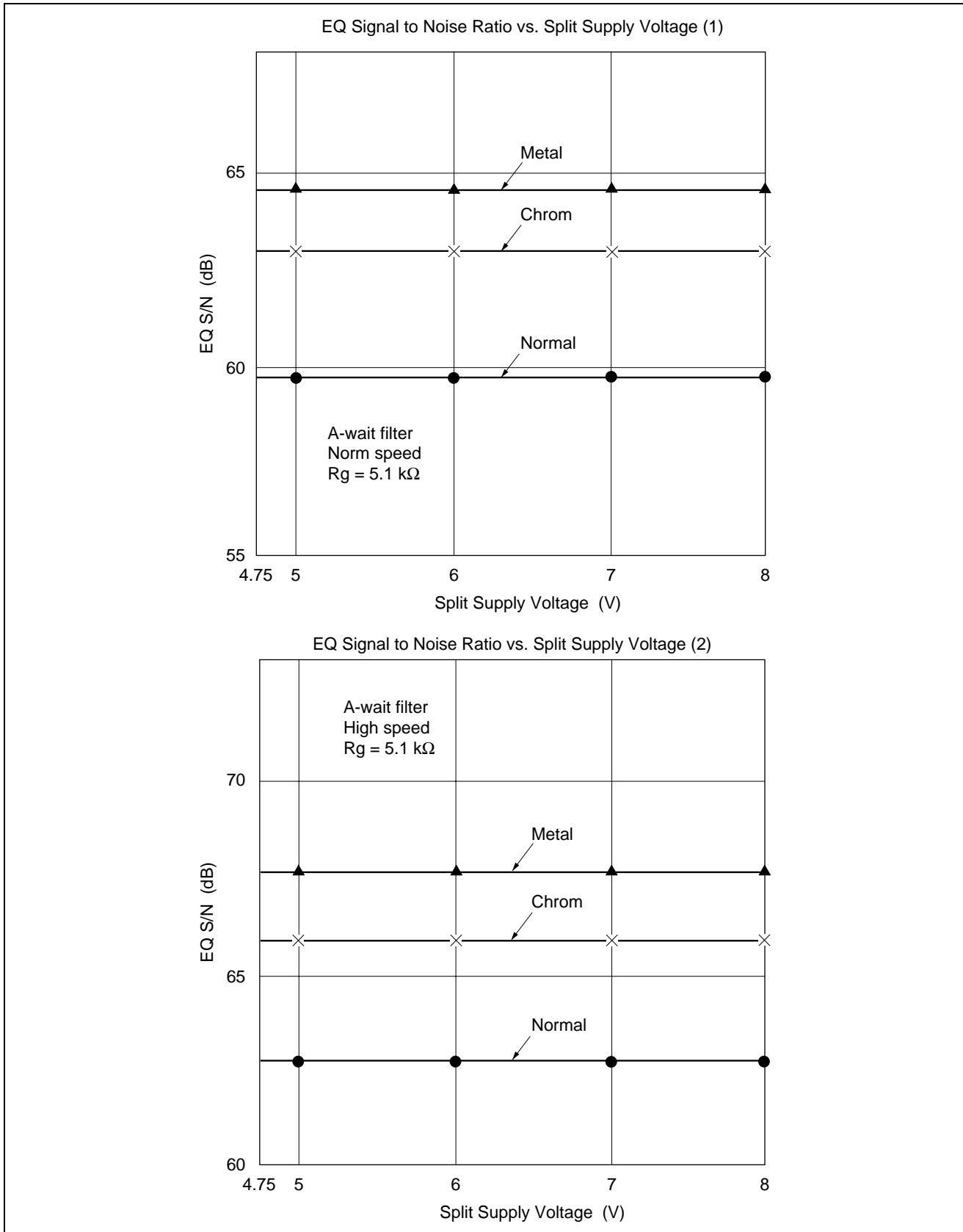

HA12203NT

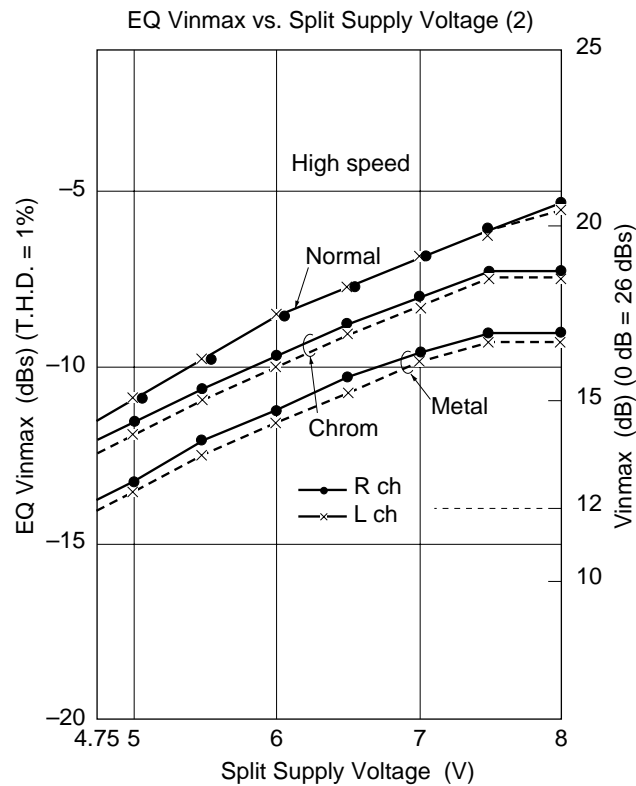
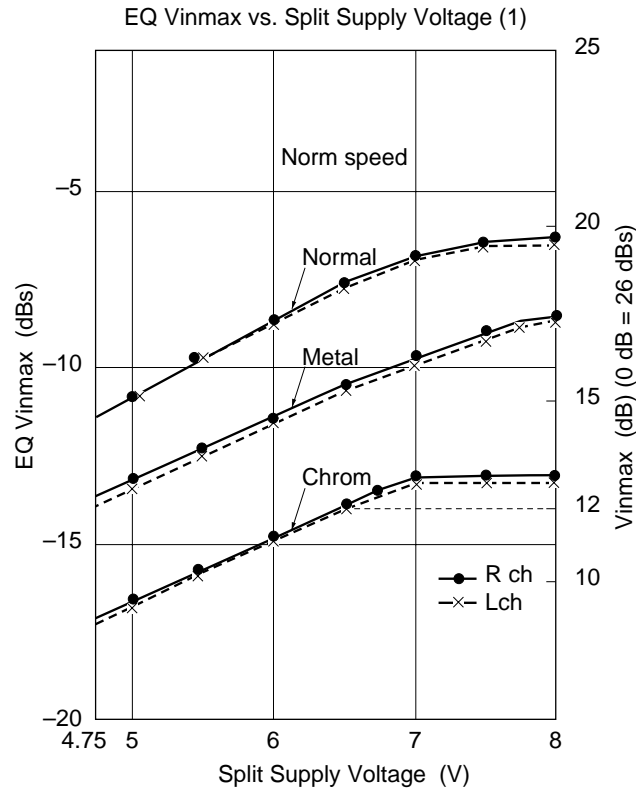

HA12203NT

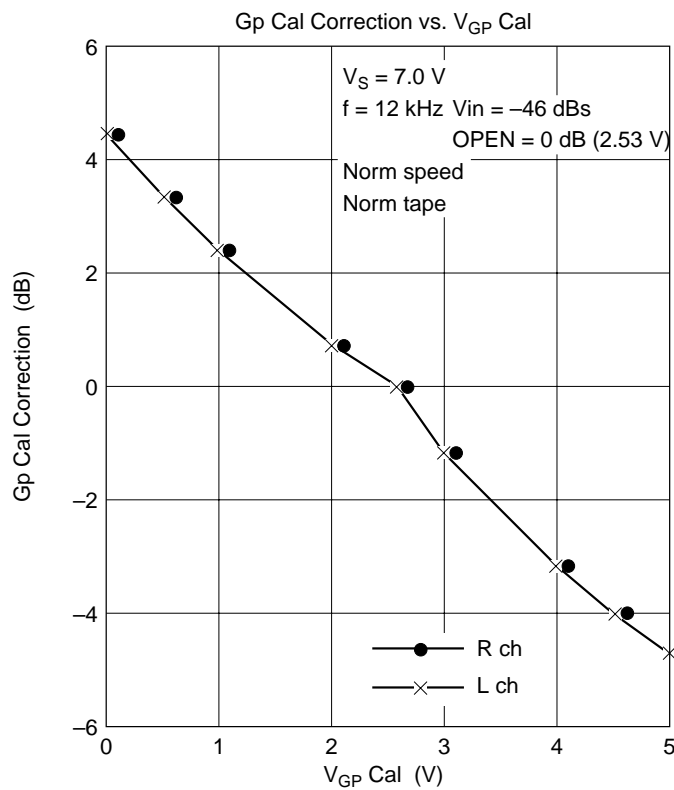
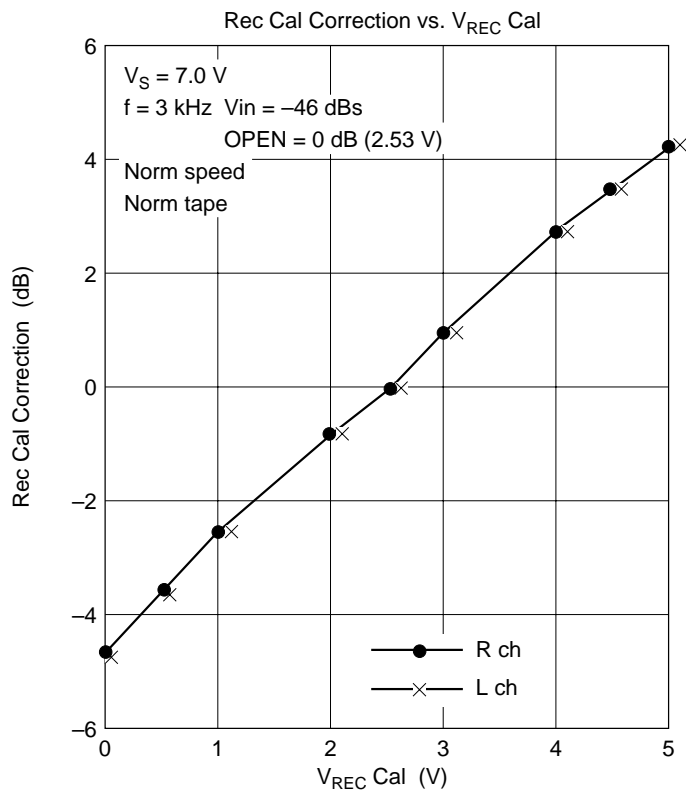

HA12203NT

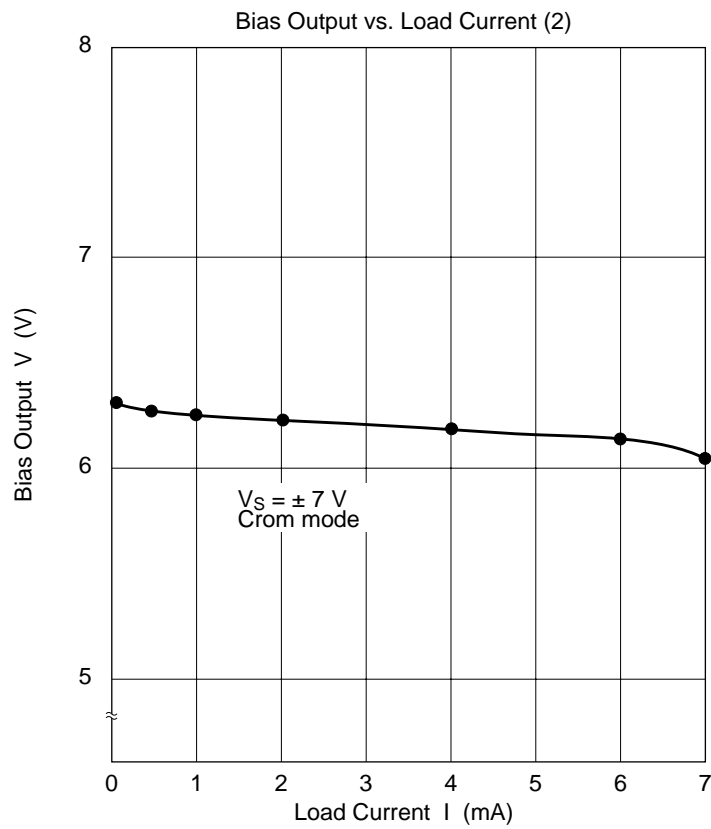
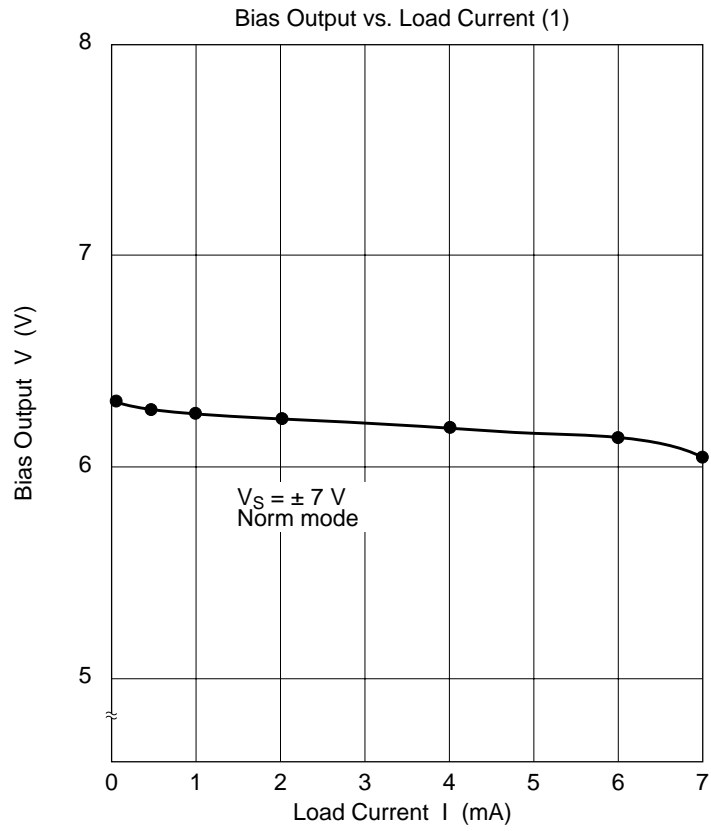

HA12203NT/HA12204NT

HA12203NT

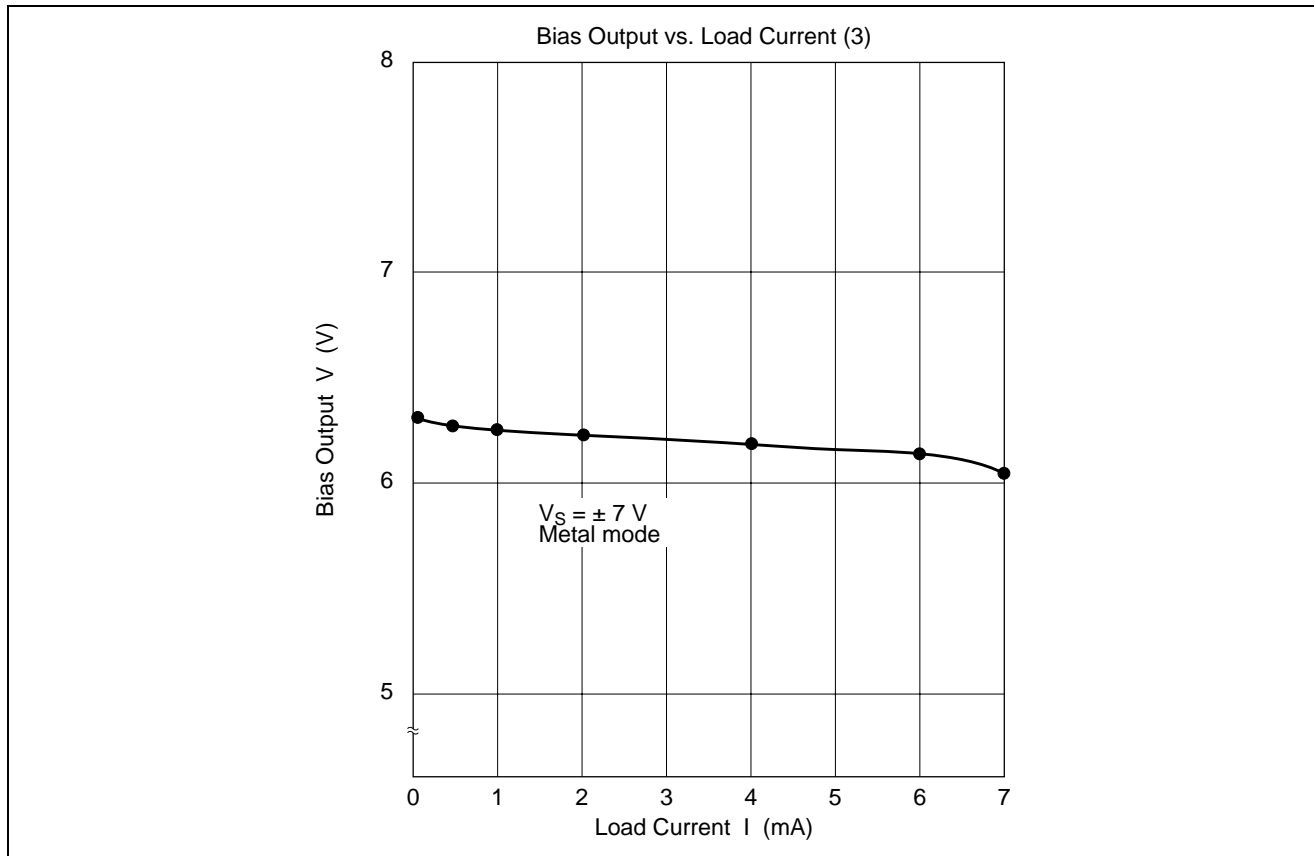

HA12203NT

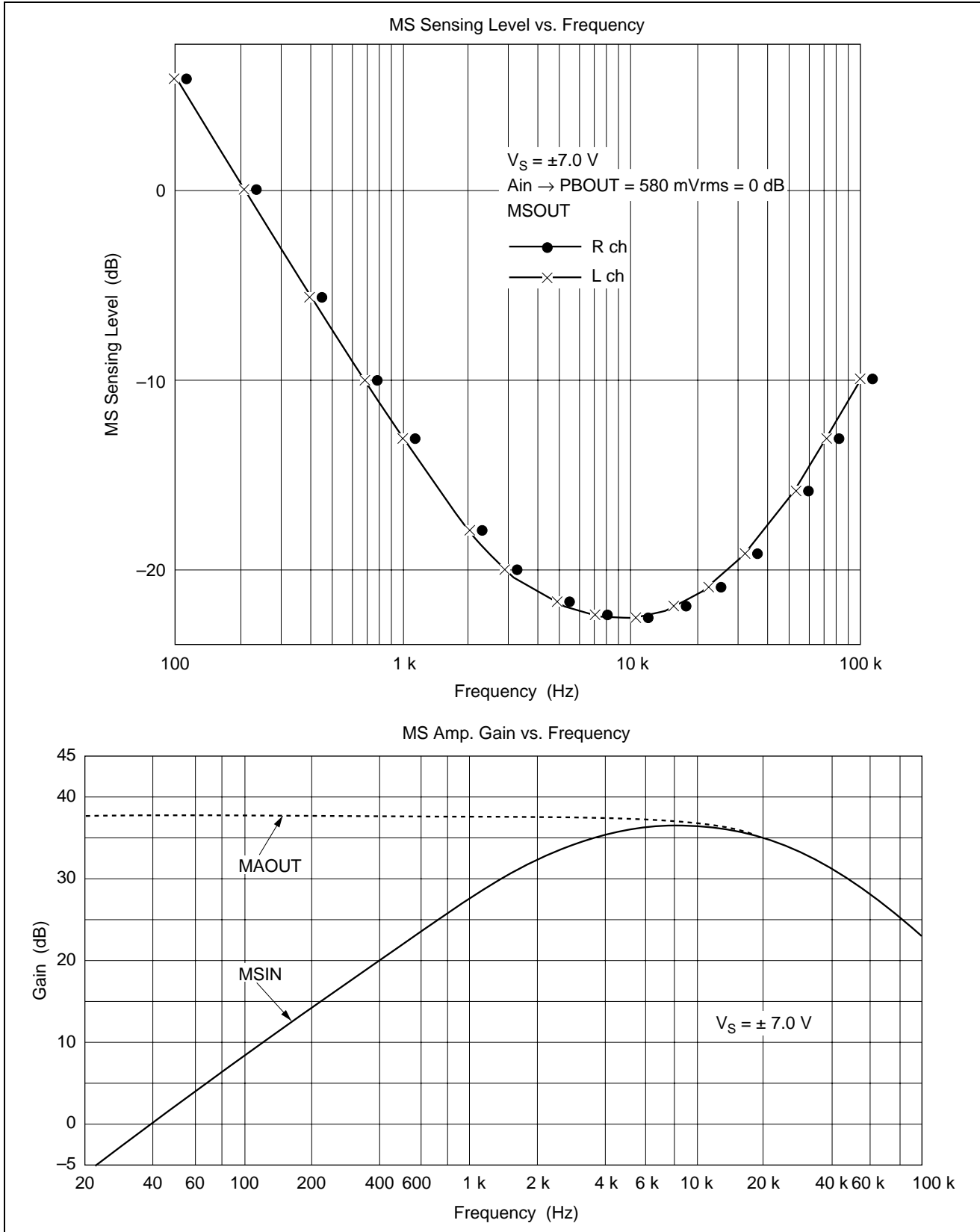

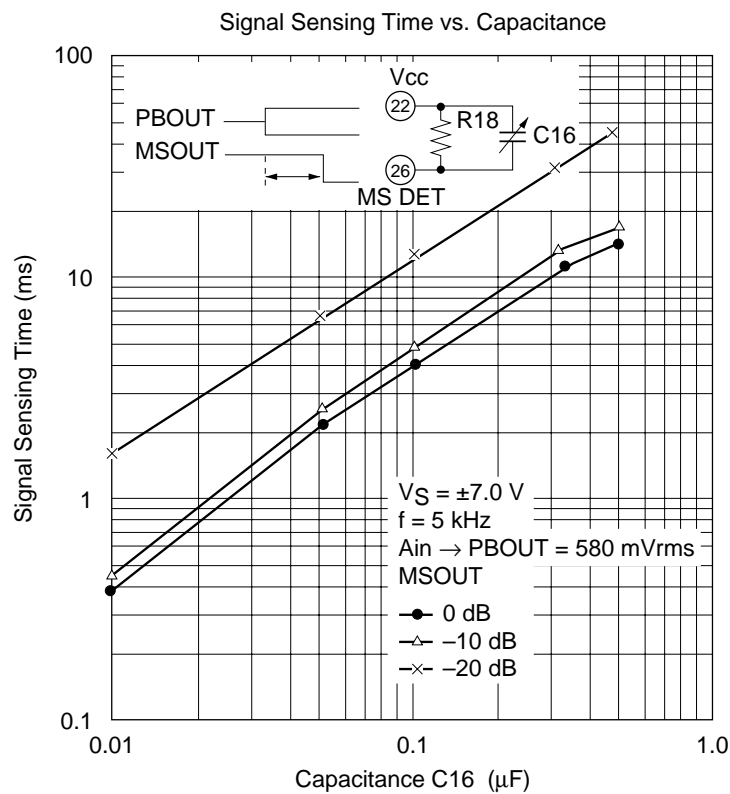
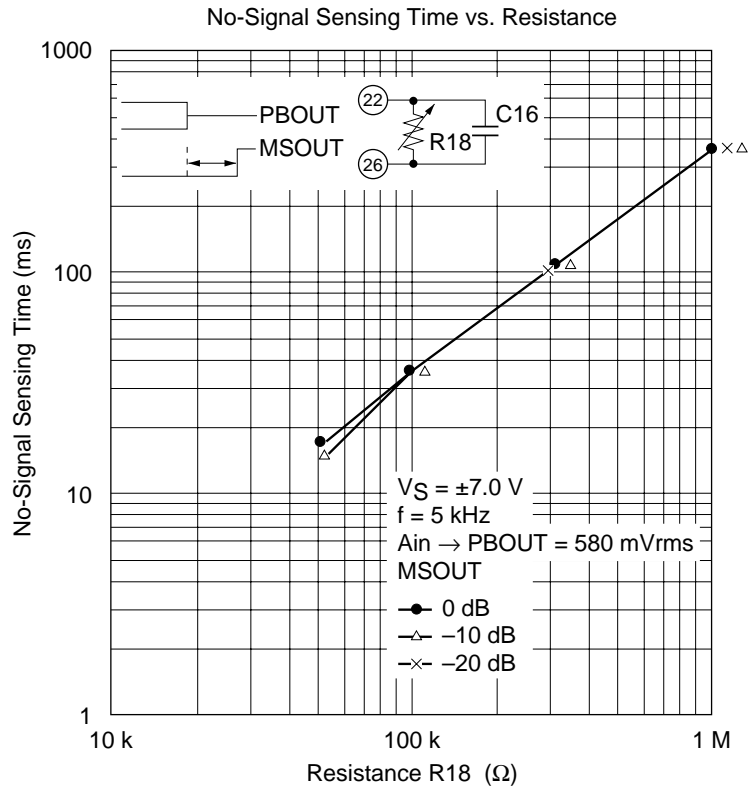

HA12204NT

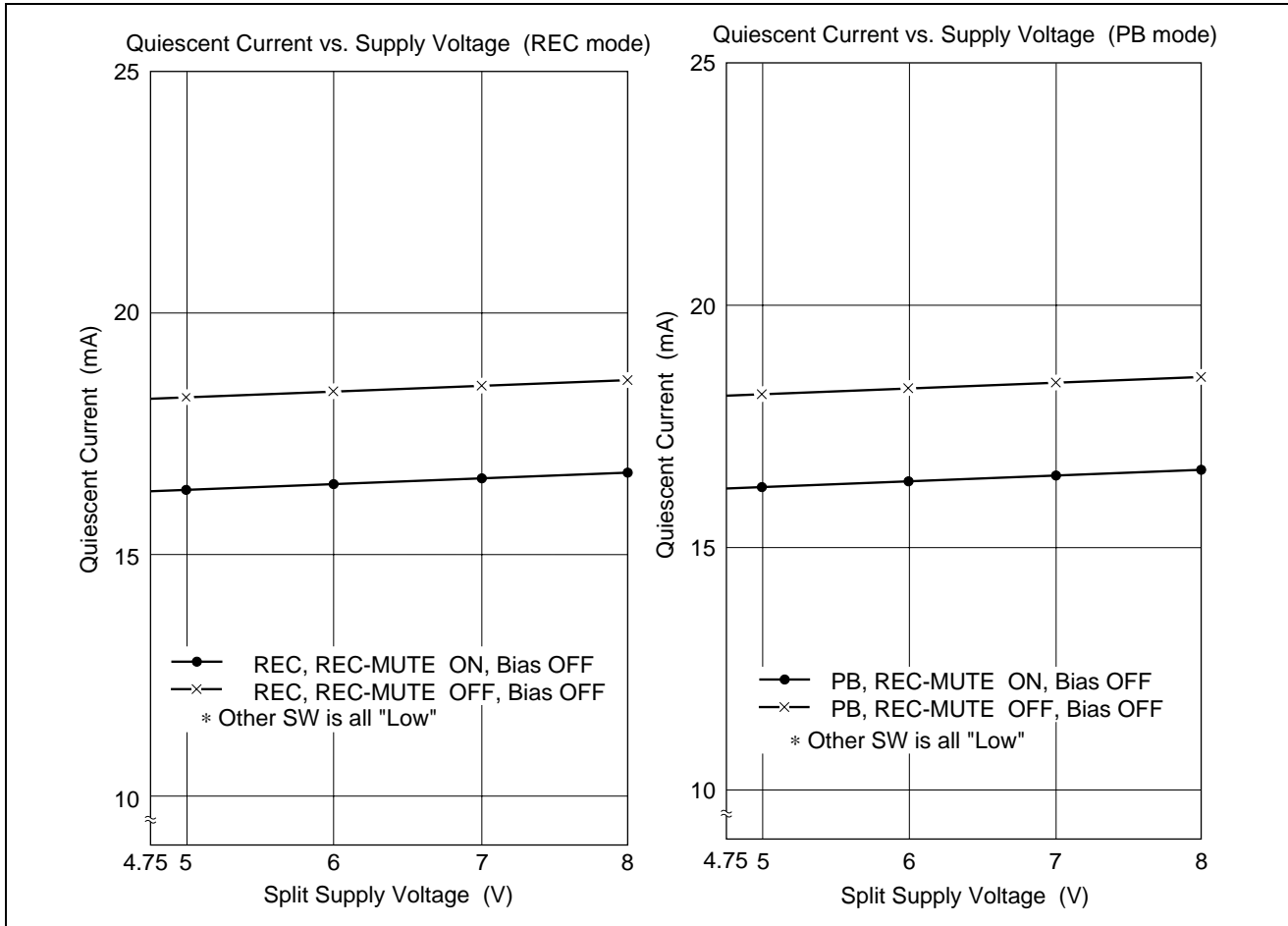

HA12203NT/HA12204NT

HA12204NT

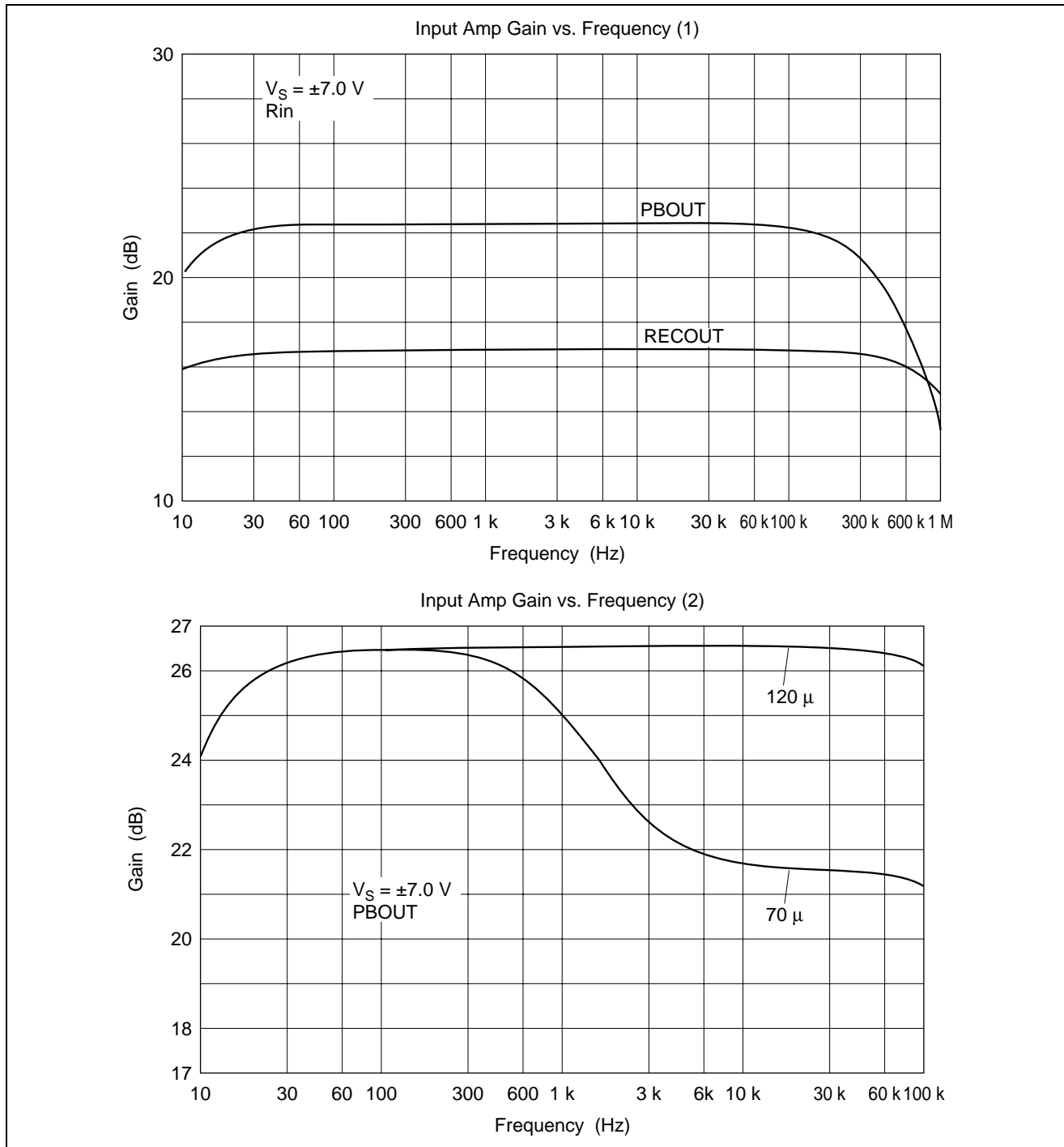

HA12204NT

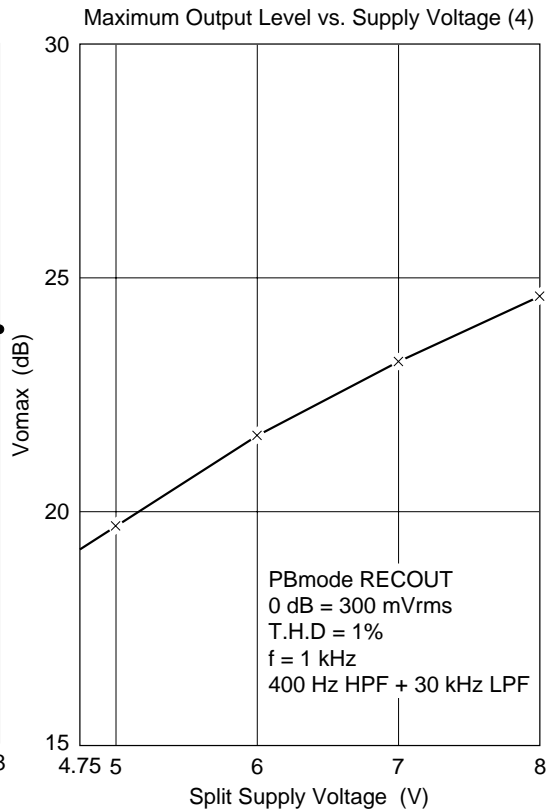
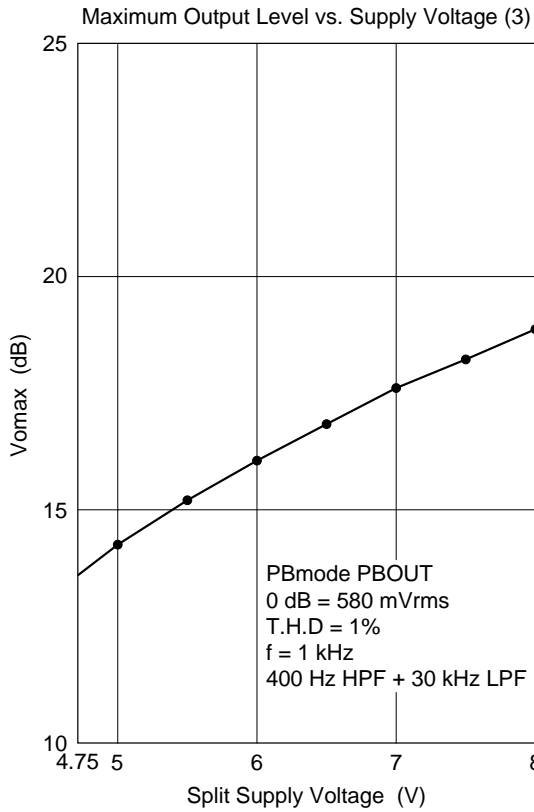
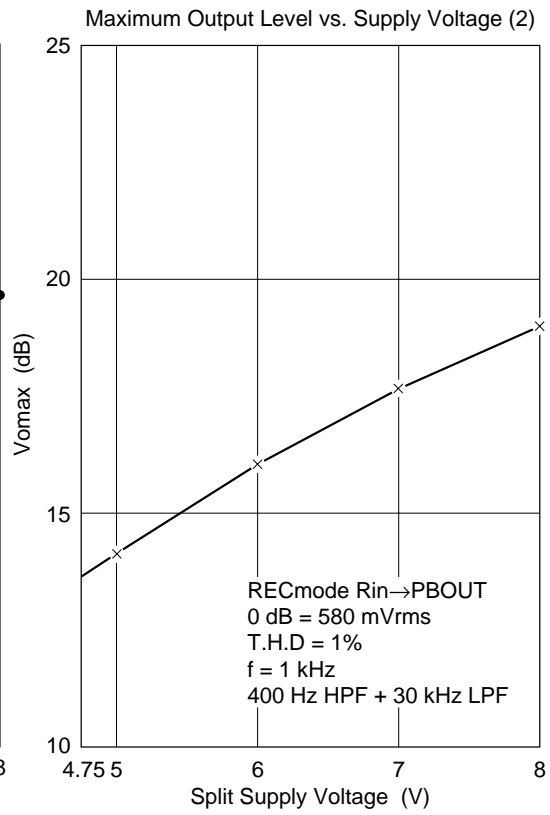
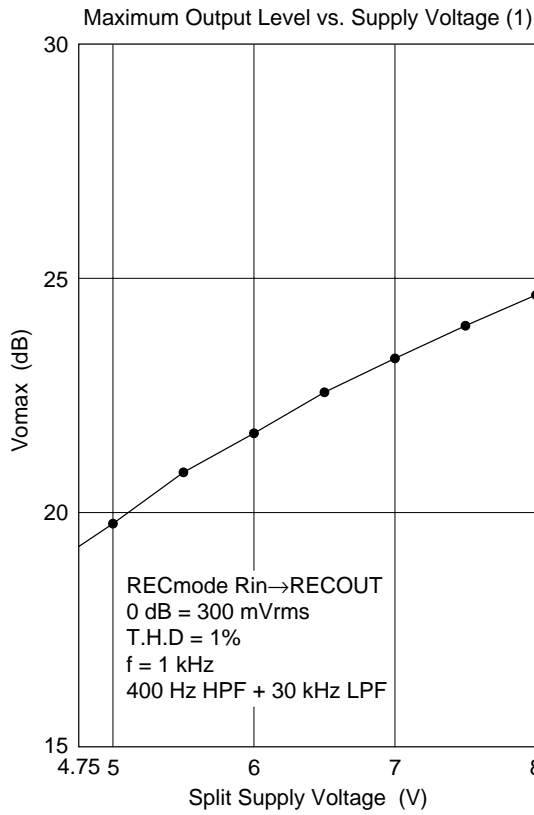

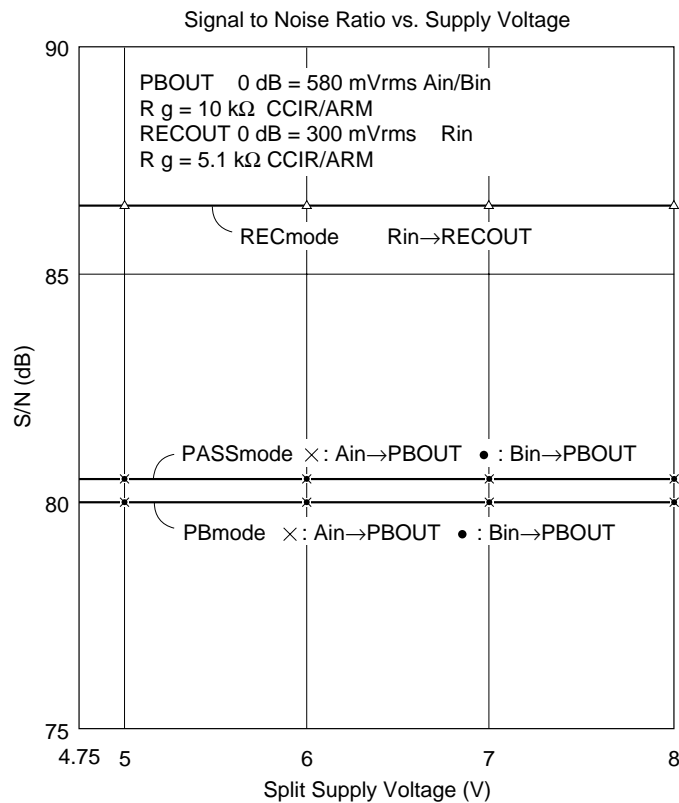
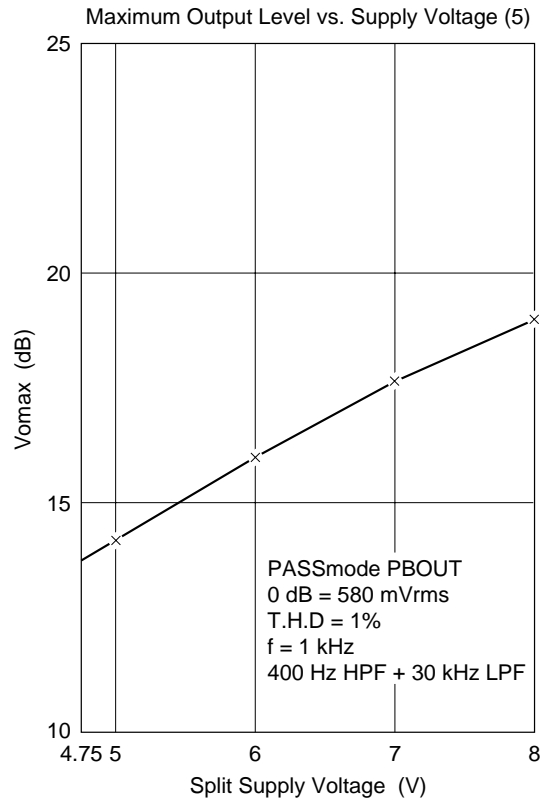

HA12204NT

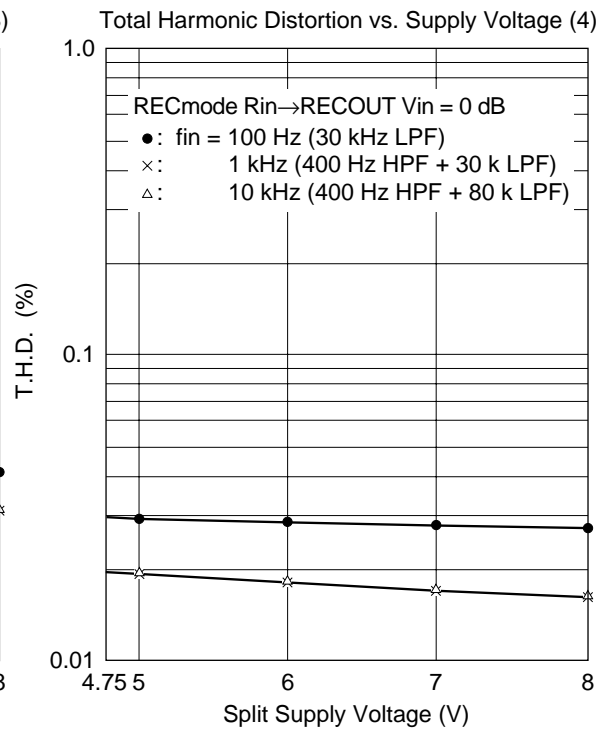
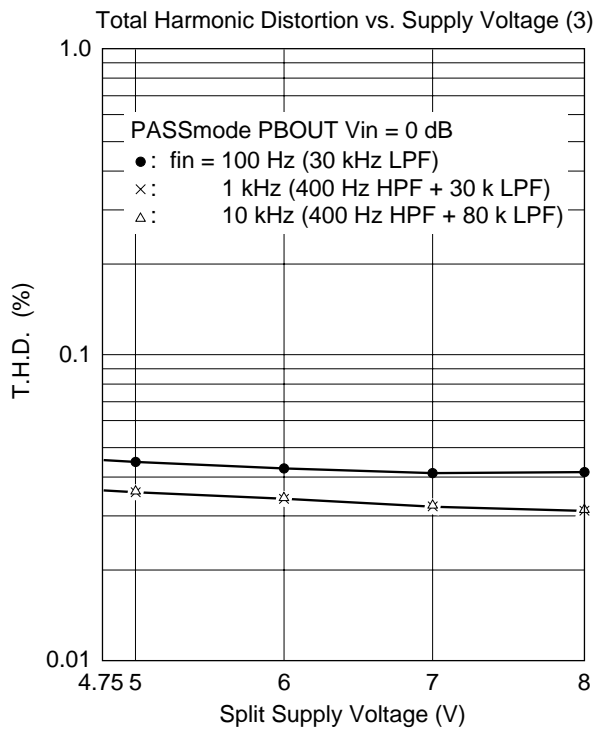
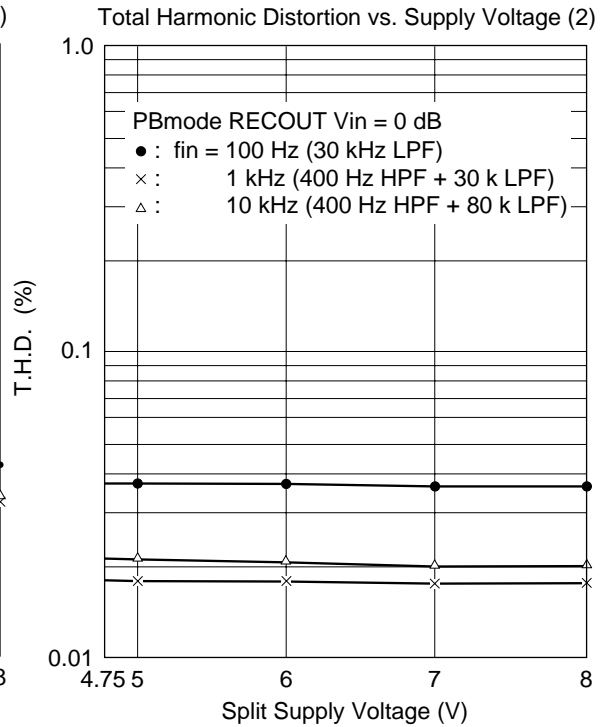
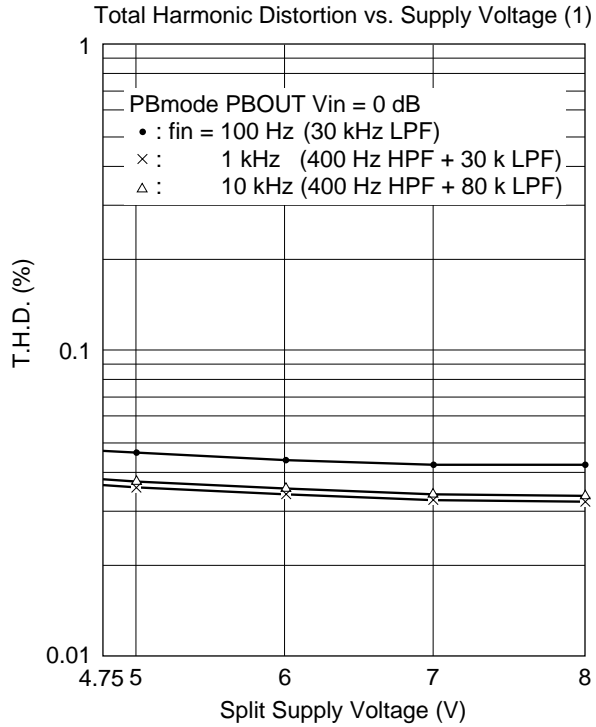

HA12204NT

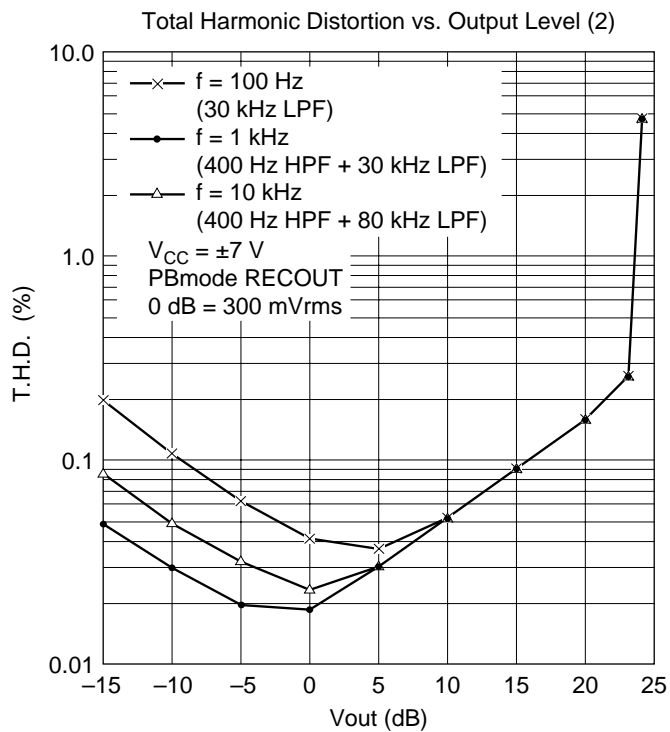
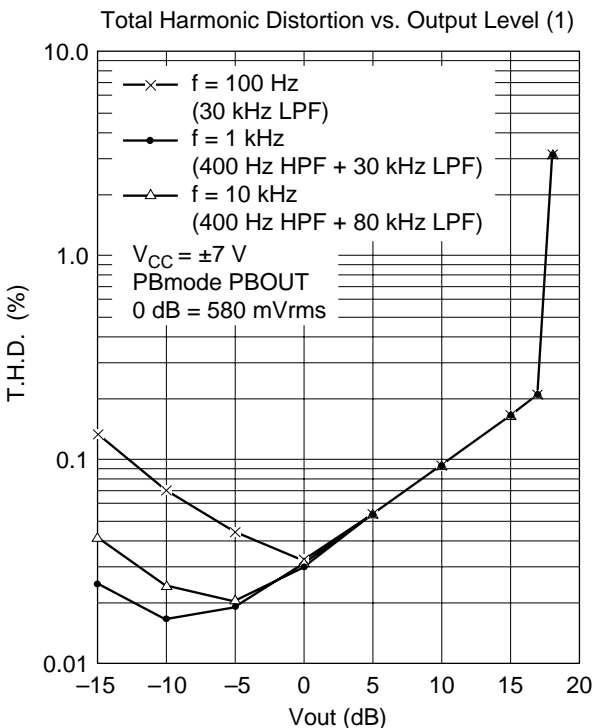
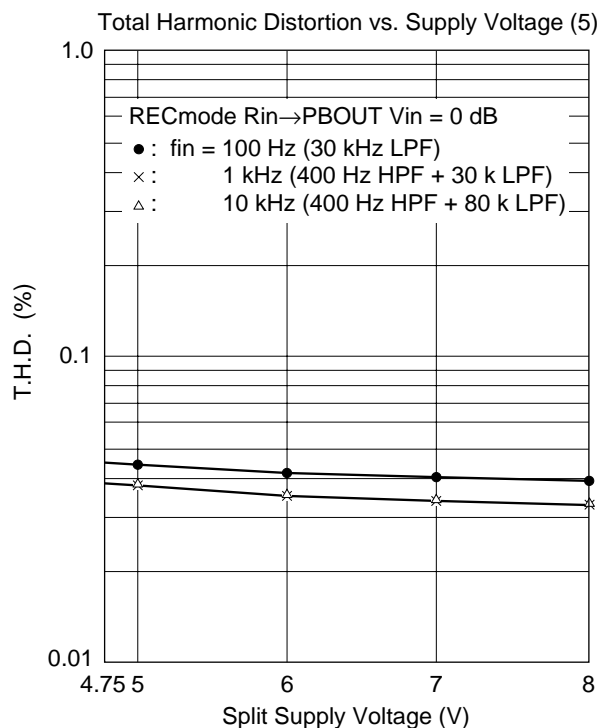

HA12204NT

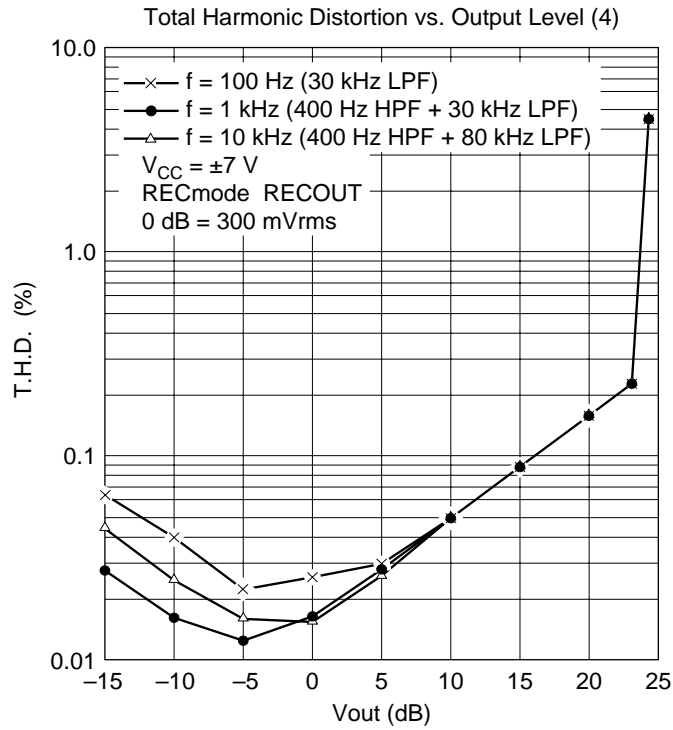
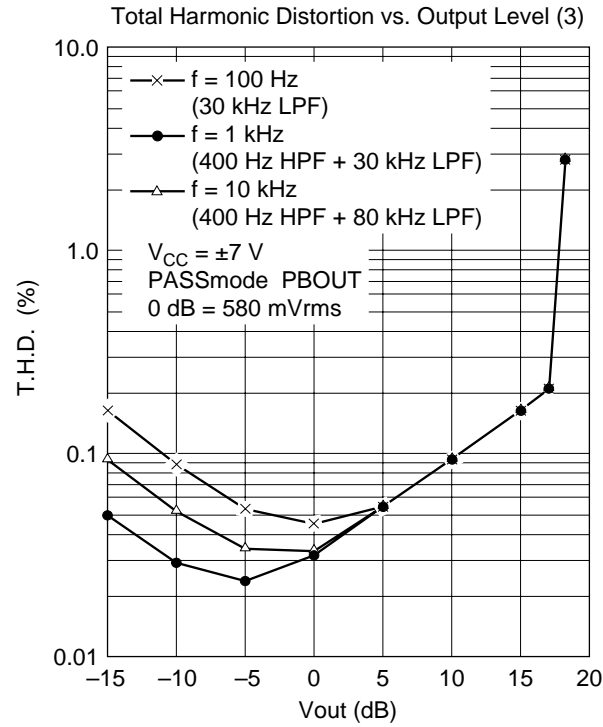

HA12203NT/HA12204NT

HA12204NT

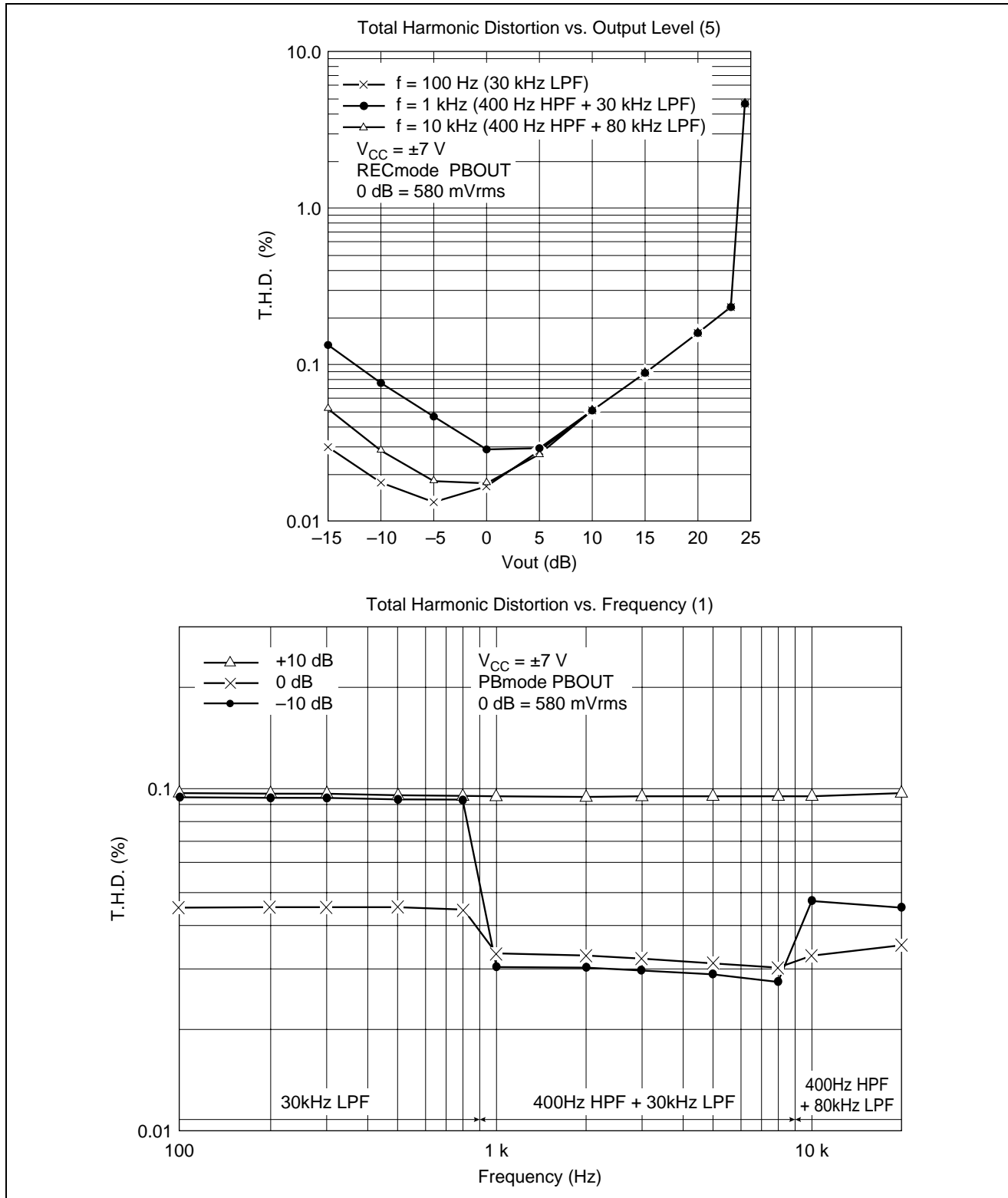

HA12204NT

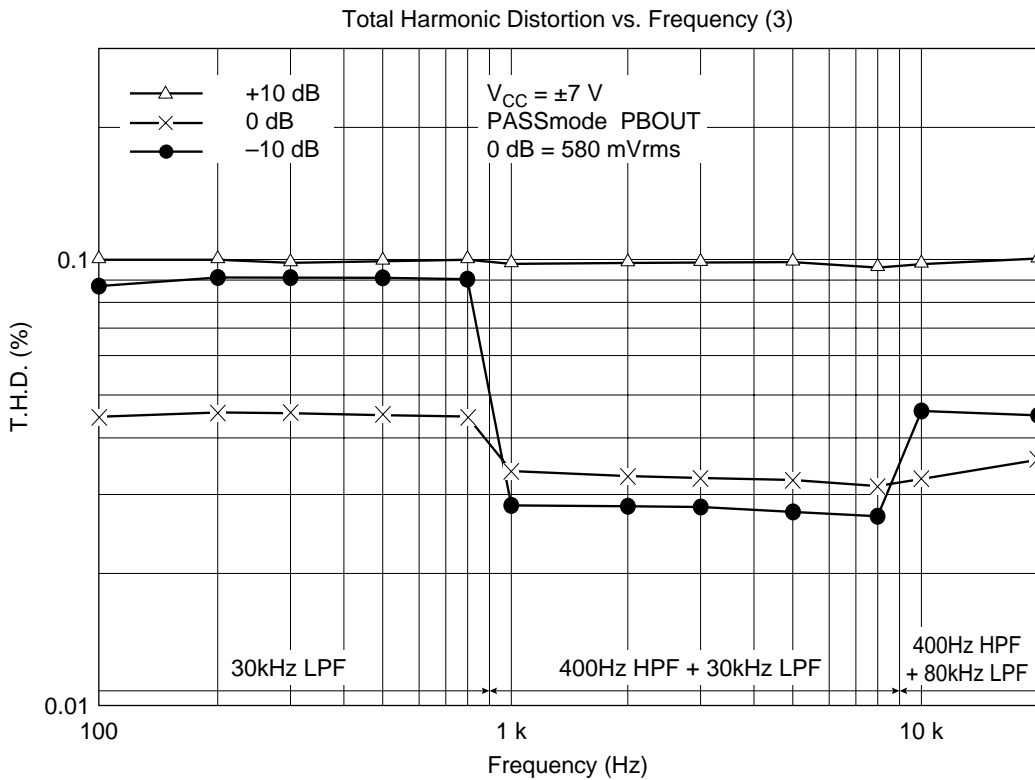
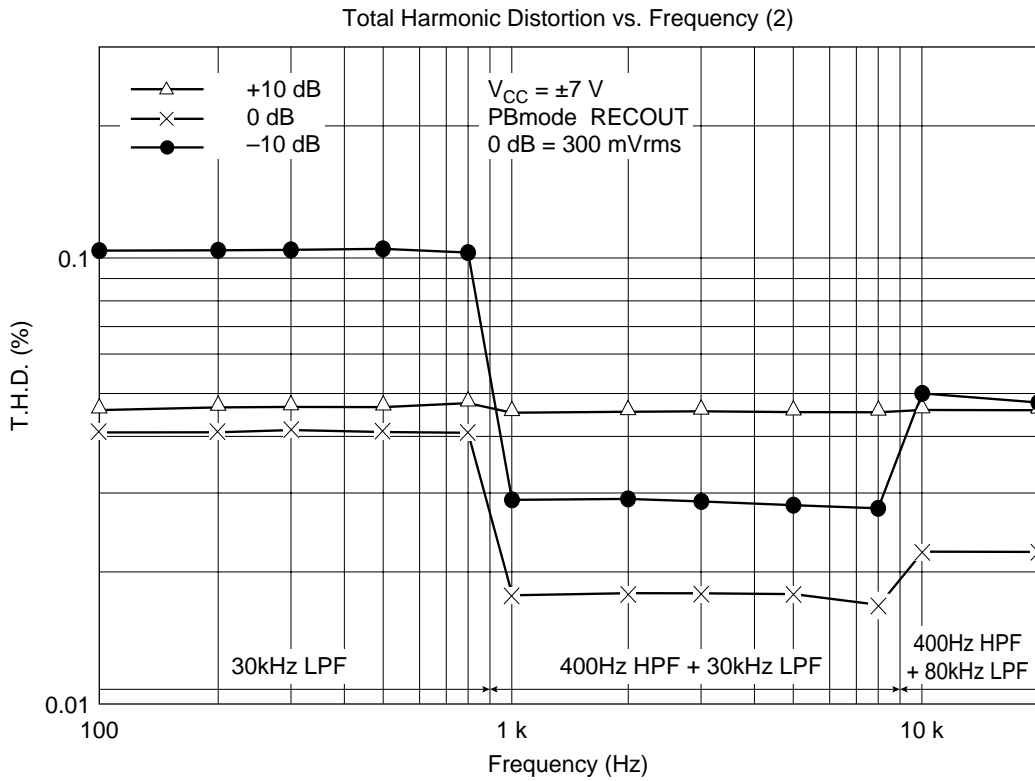

HA12204NT

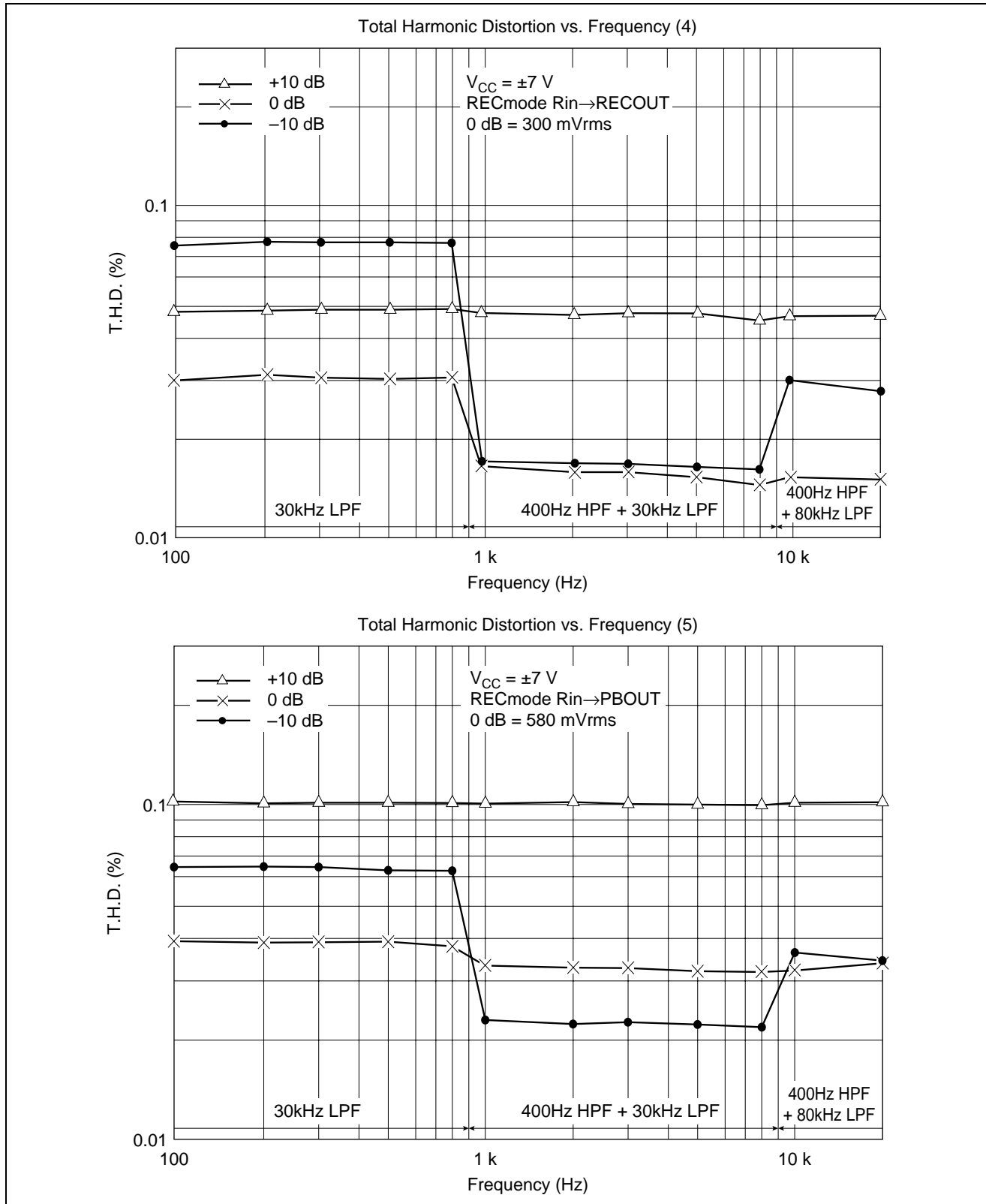

HA12204NT

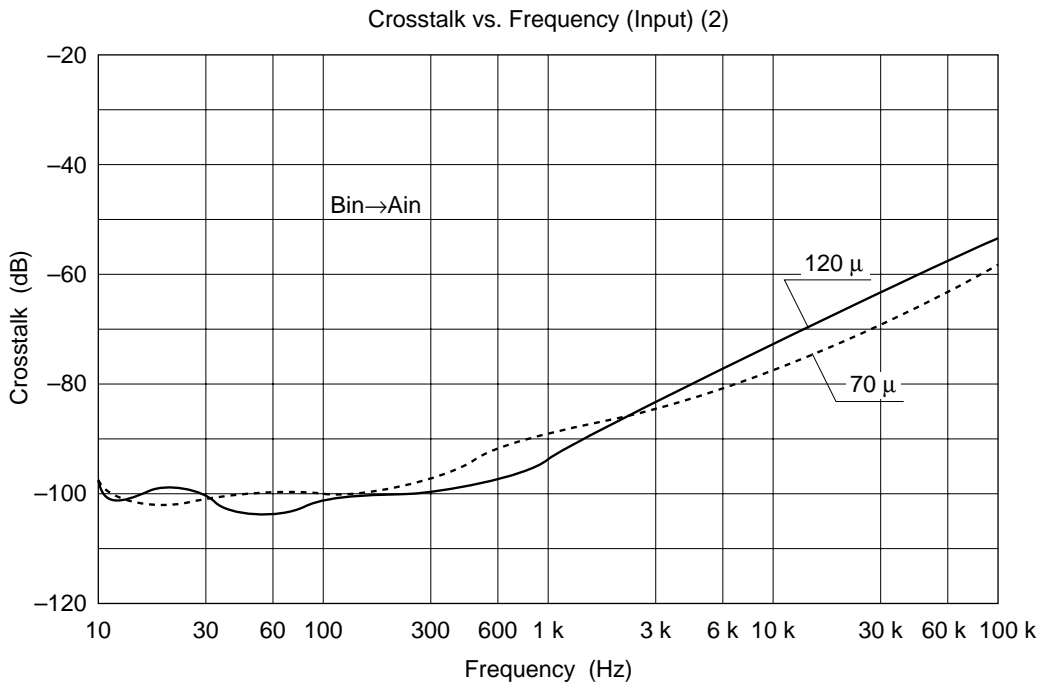
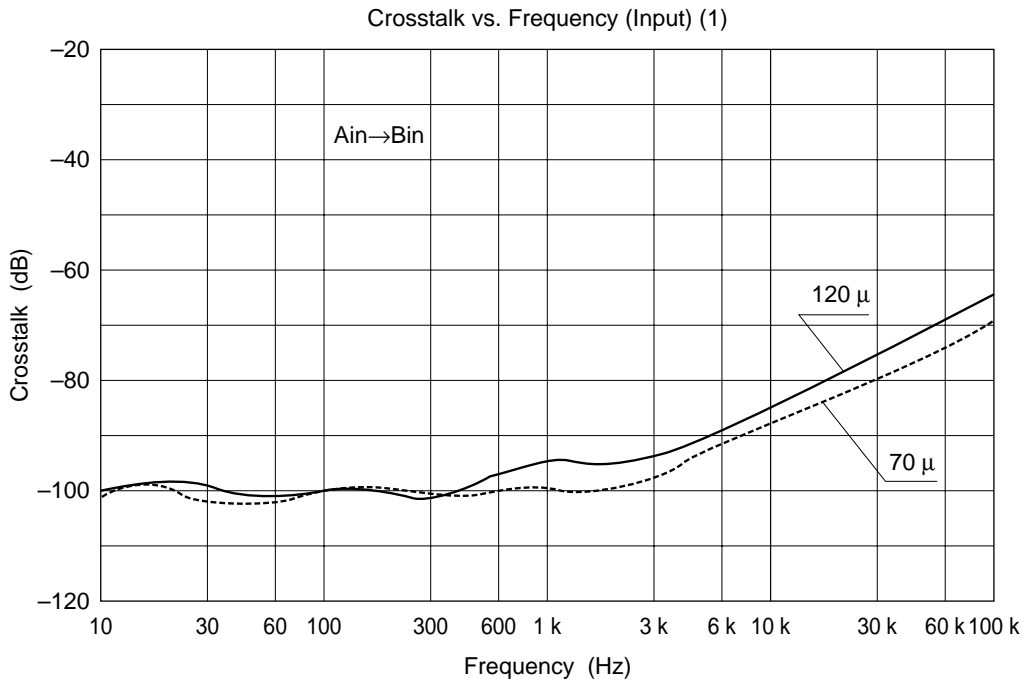

HA12203NT/HA12204NT

HA12204NT

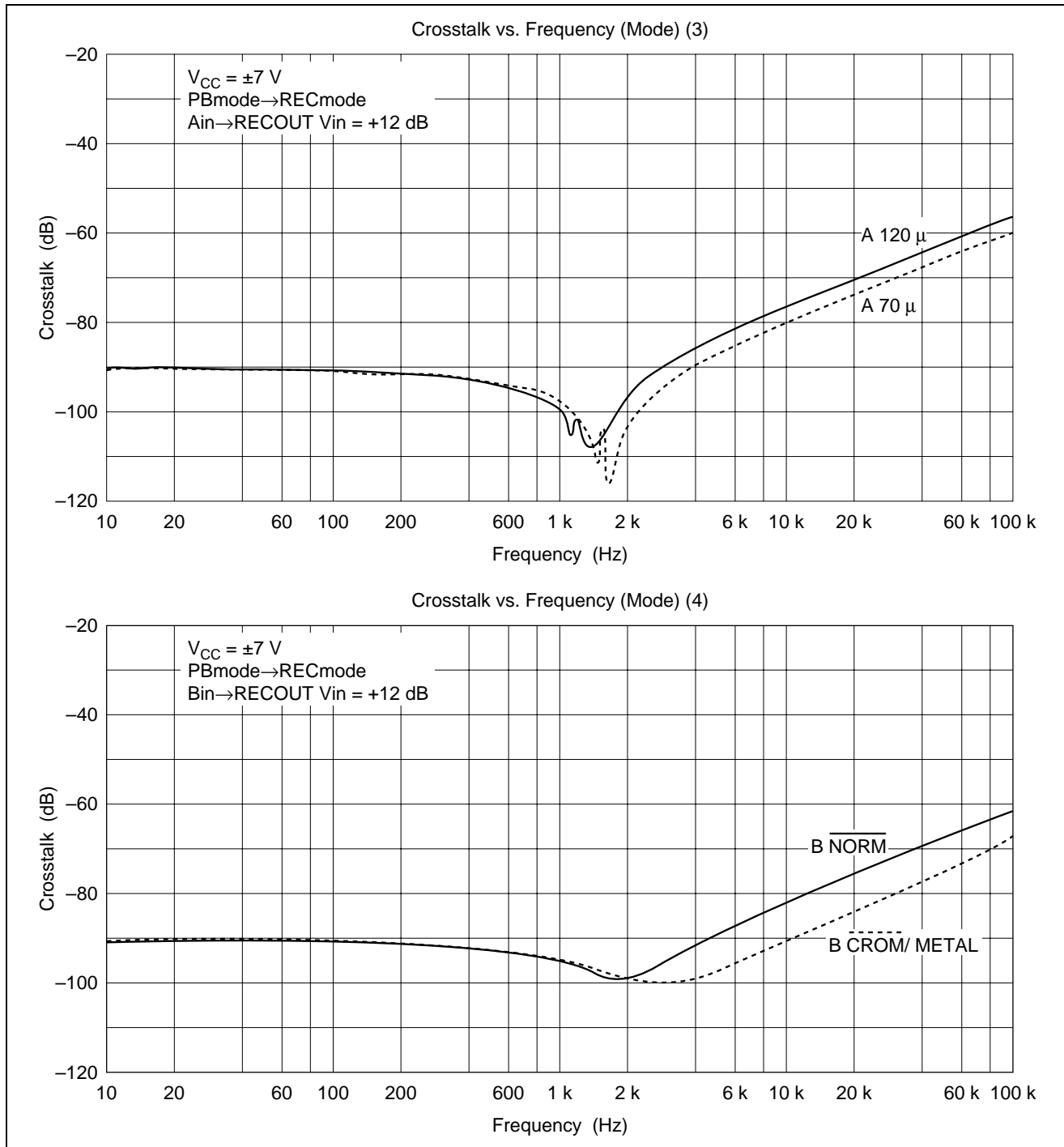

HA12204NT

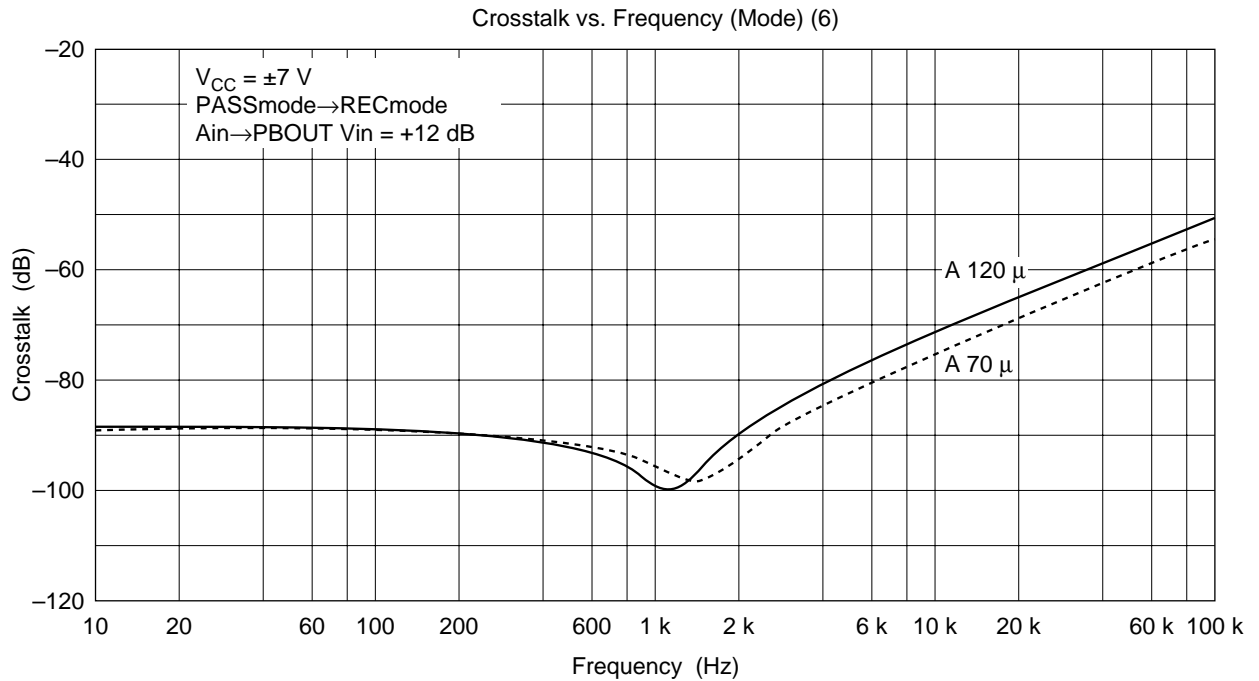
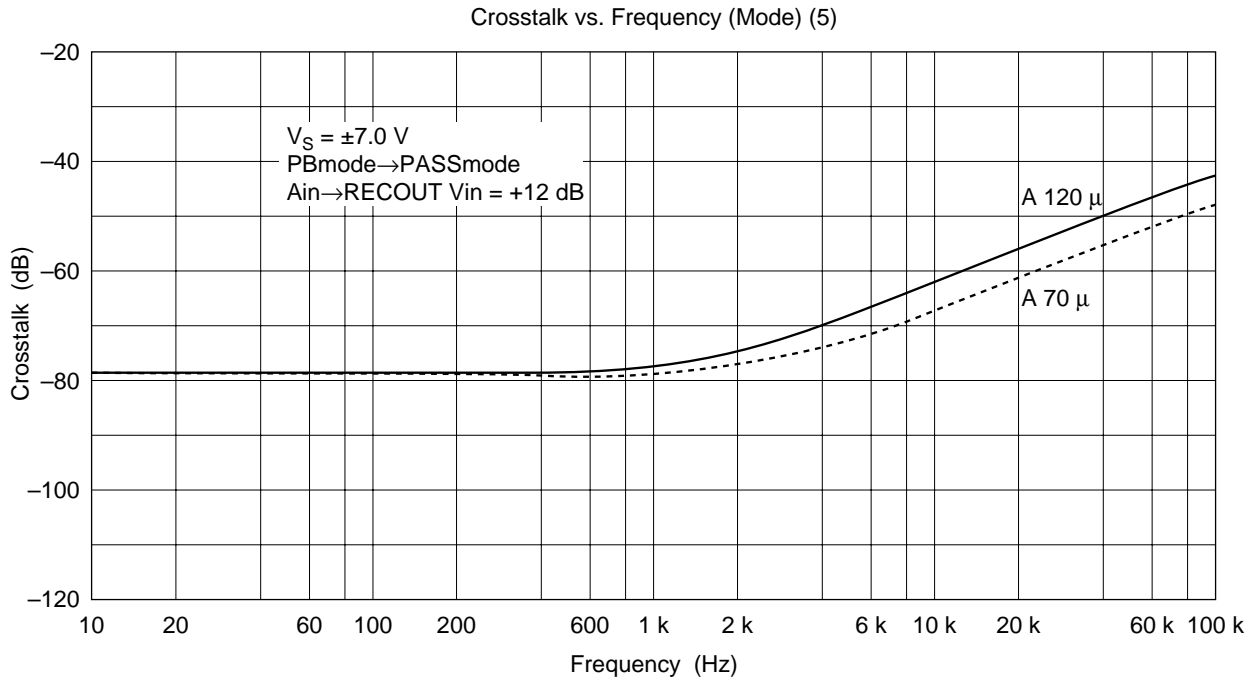

HA12203NT/HA12204NT

HA12204NT

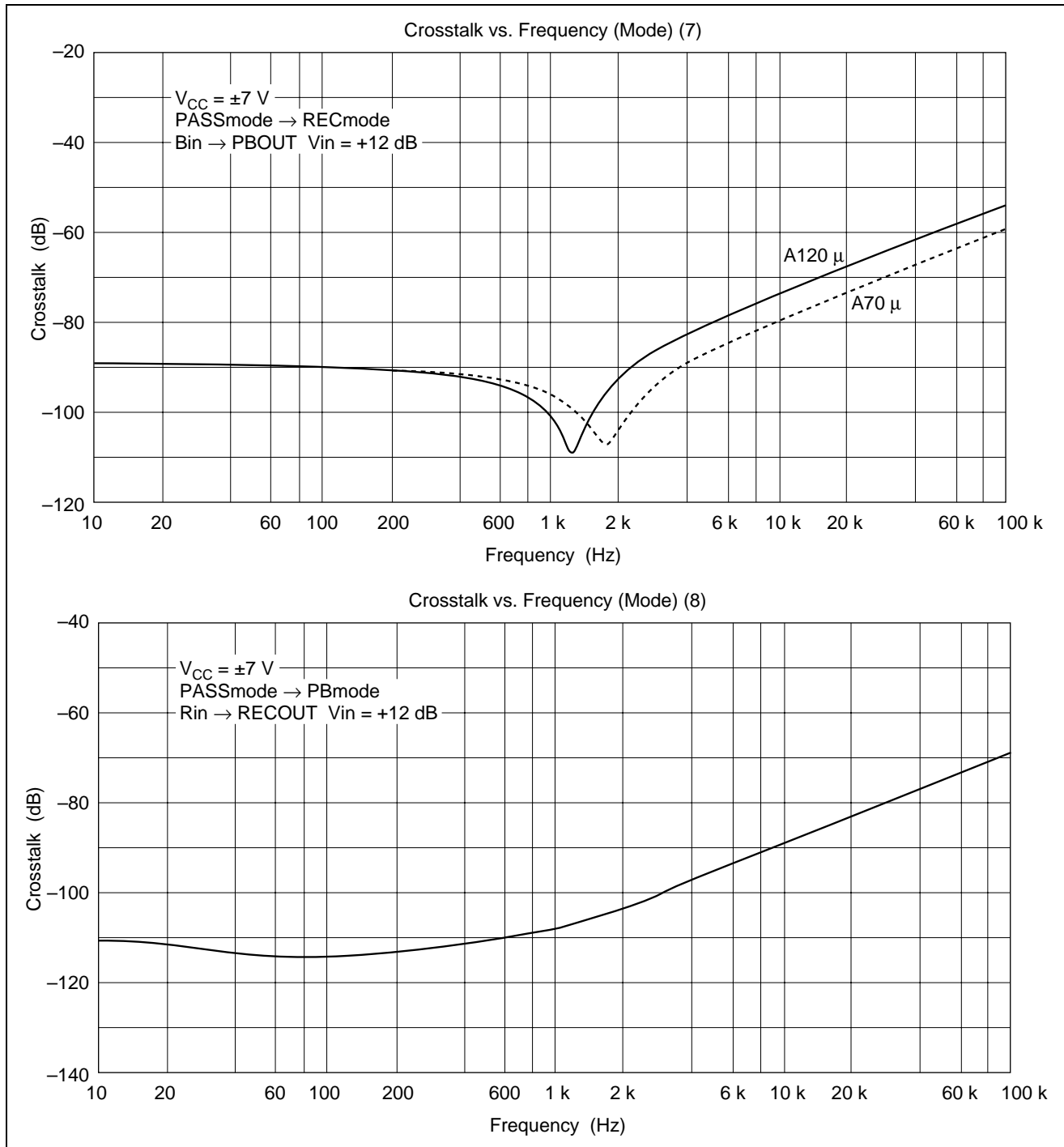

HA12204NT

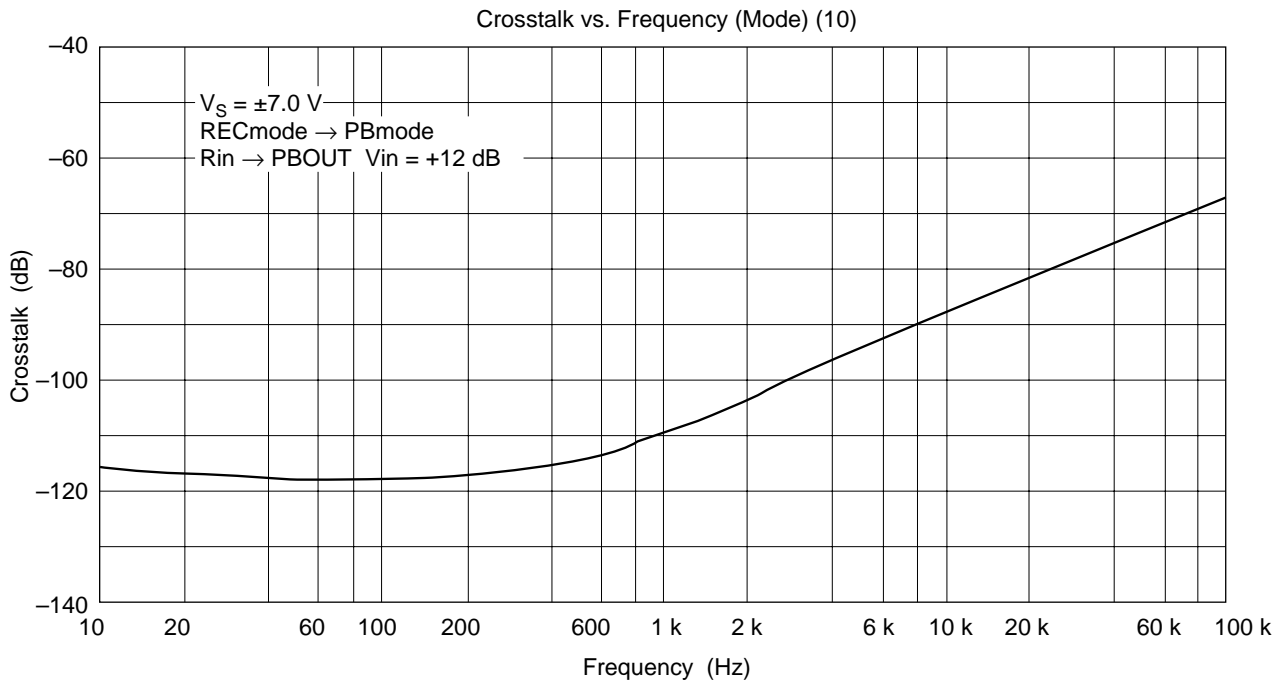
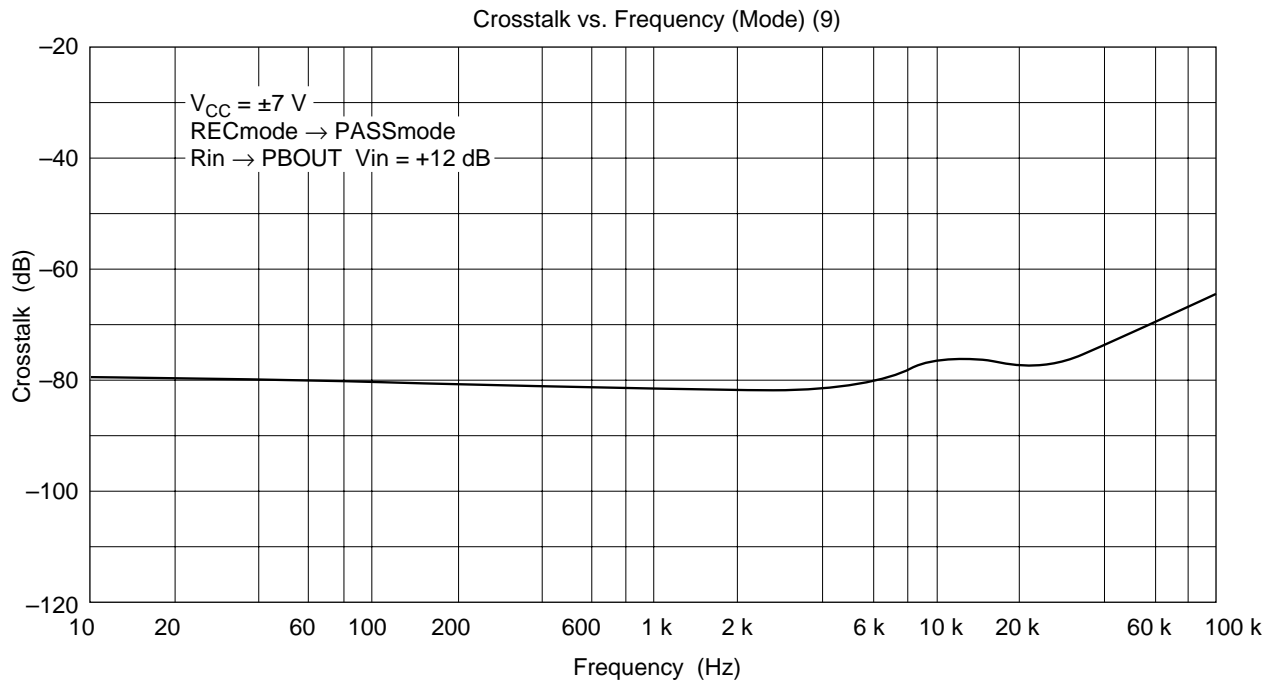

HA12203NT/HA12204NT

HA12204NT

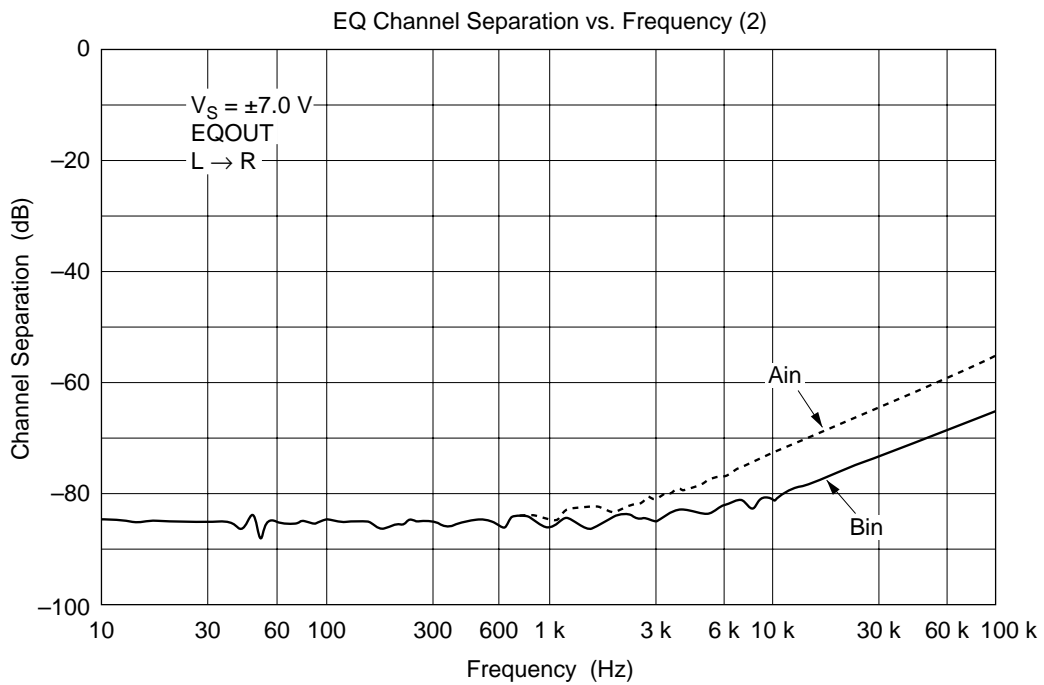
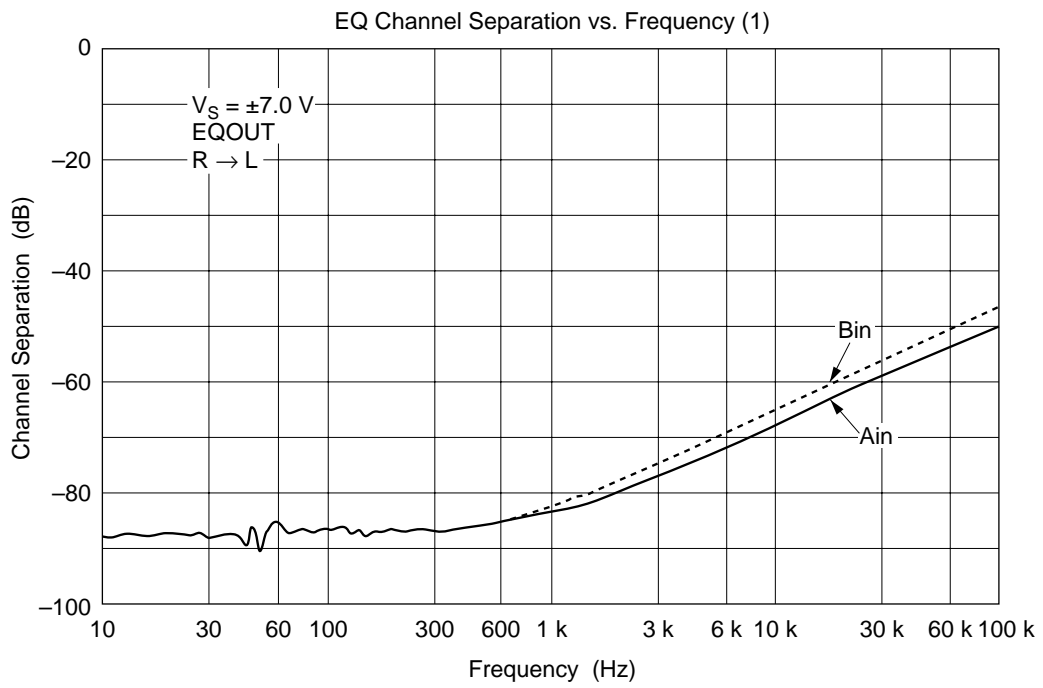

HA12204NT

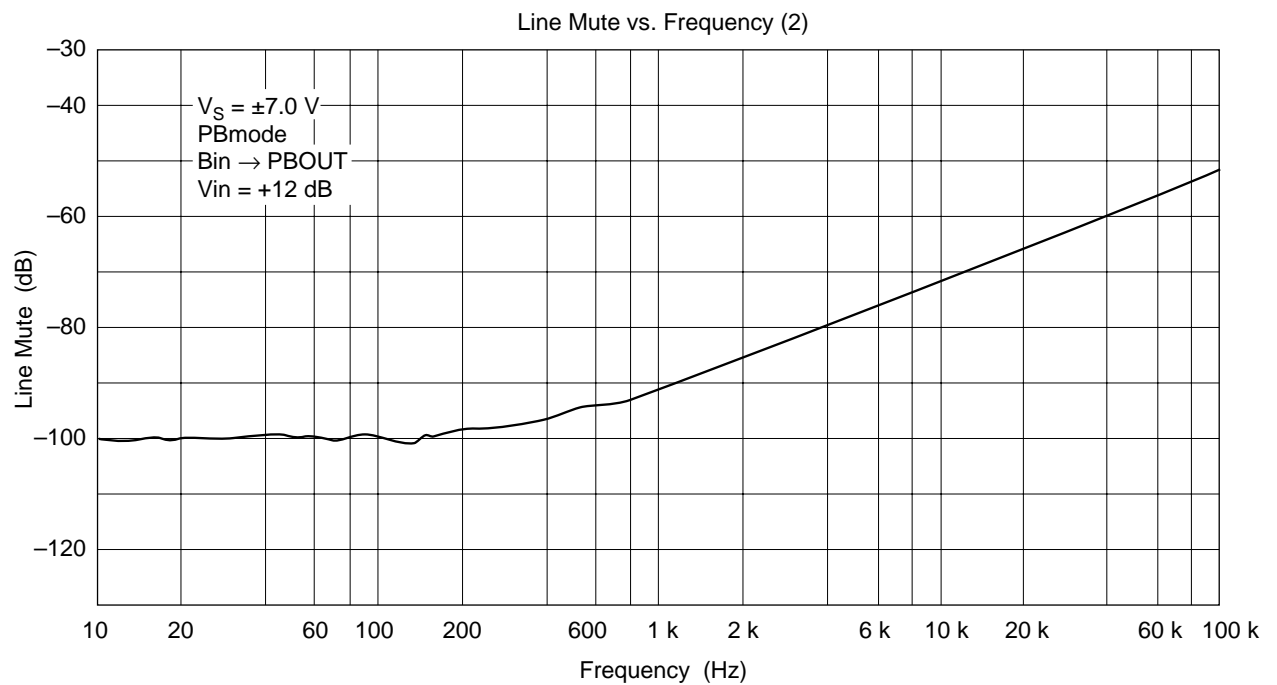
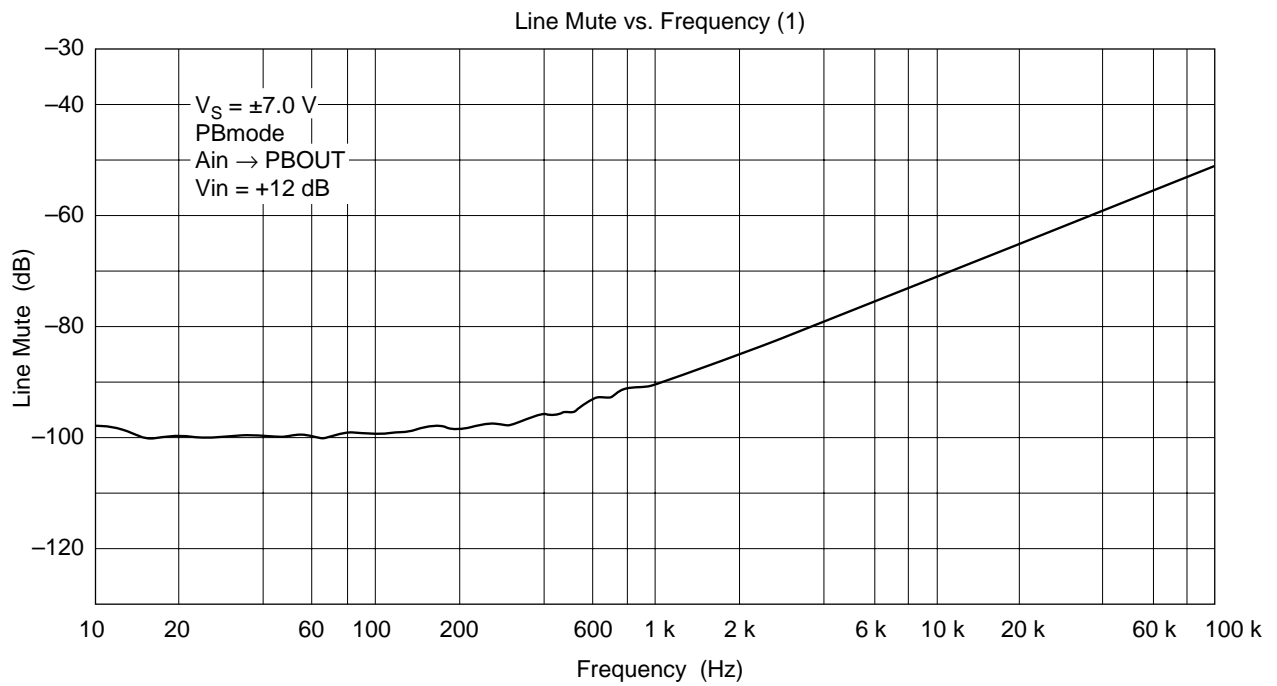

HA12203NT/HA12204NT

HA12204NT

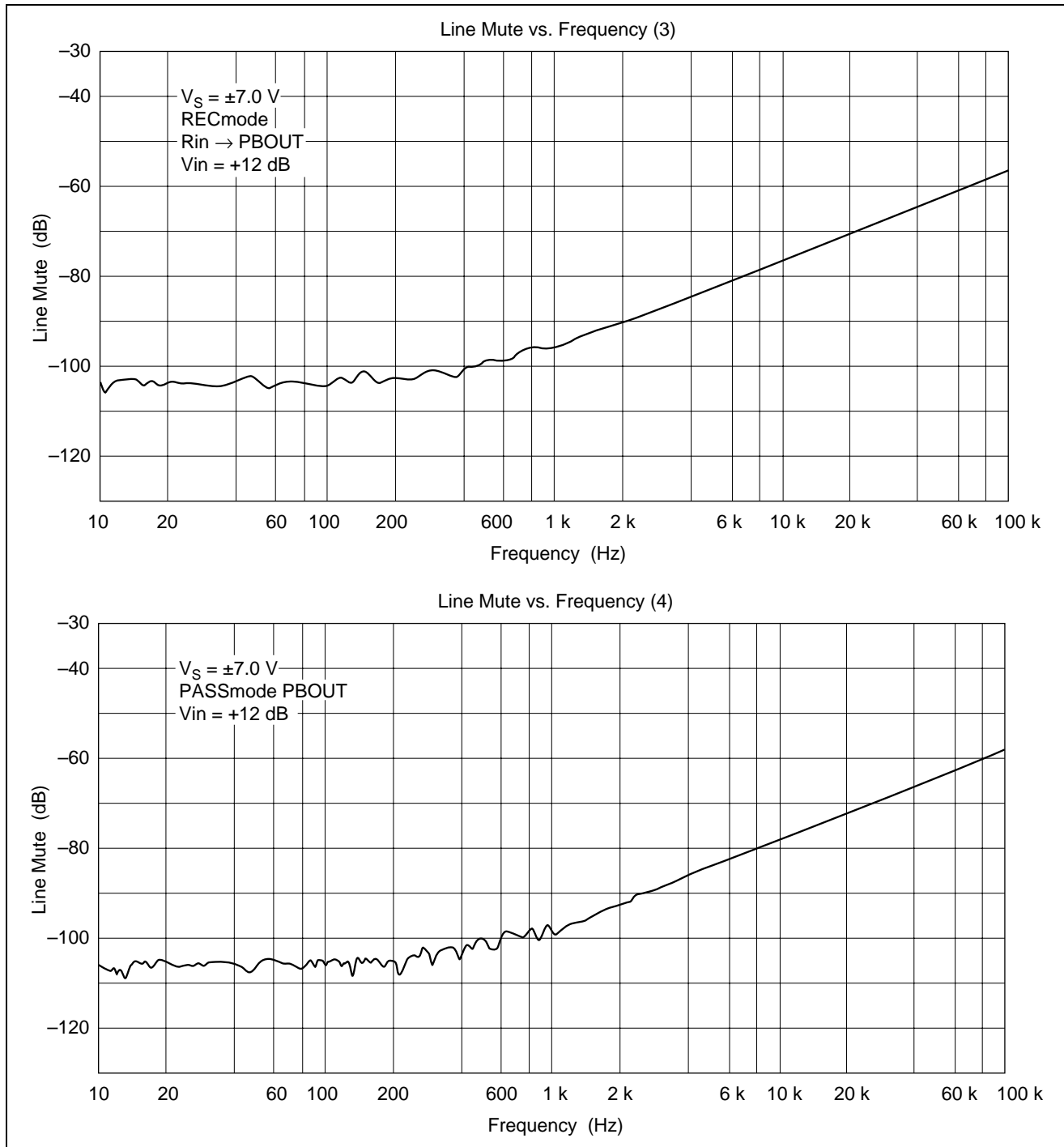

HA12204NT

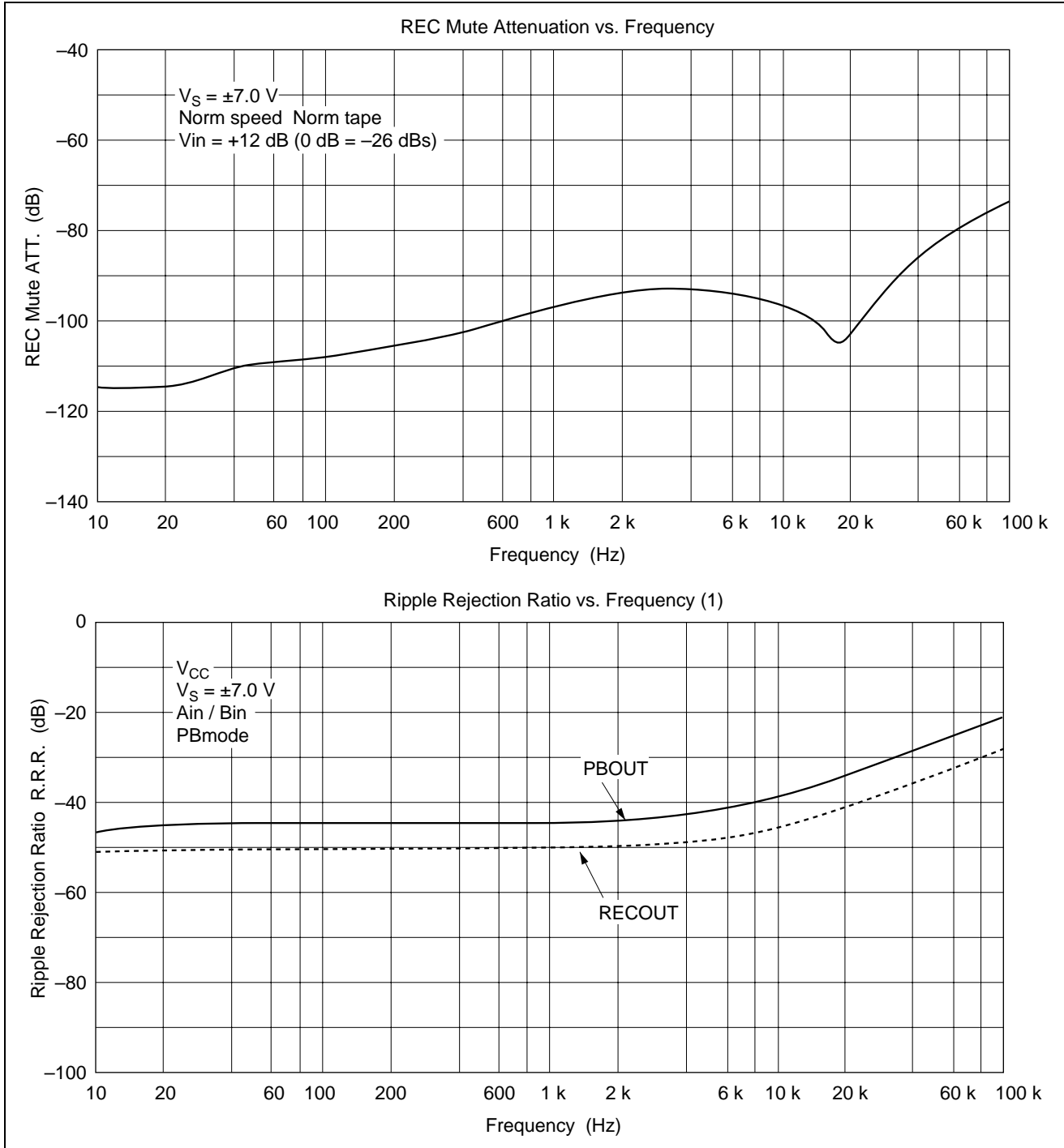

HA12203NT/HA12204NT

HA12204NT

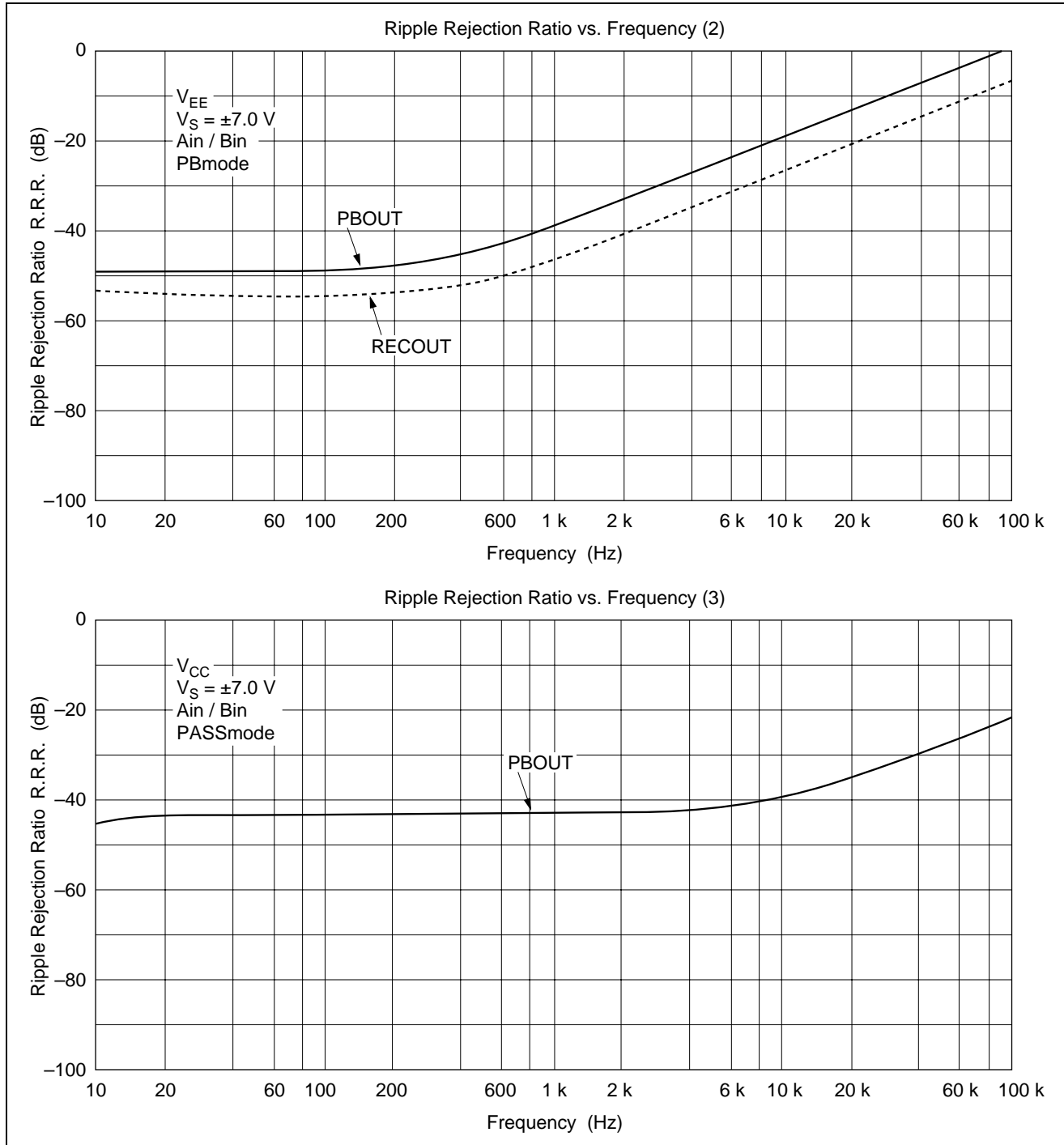

HA12204NT

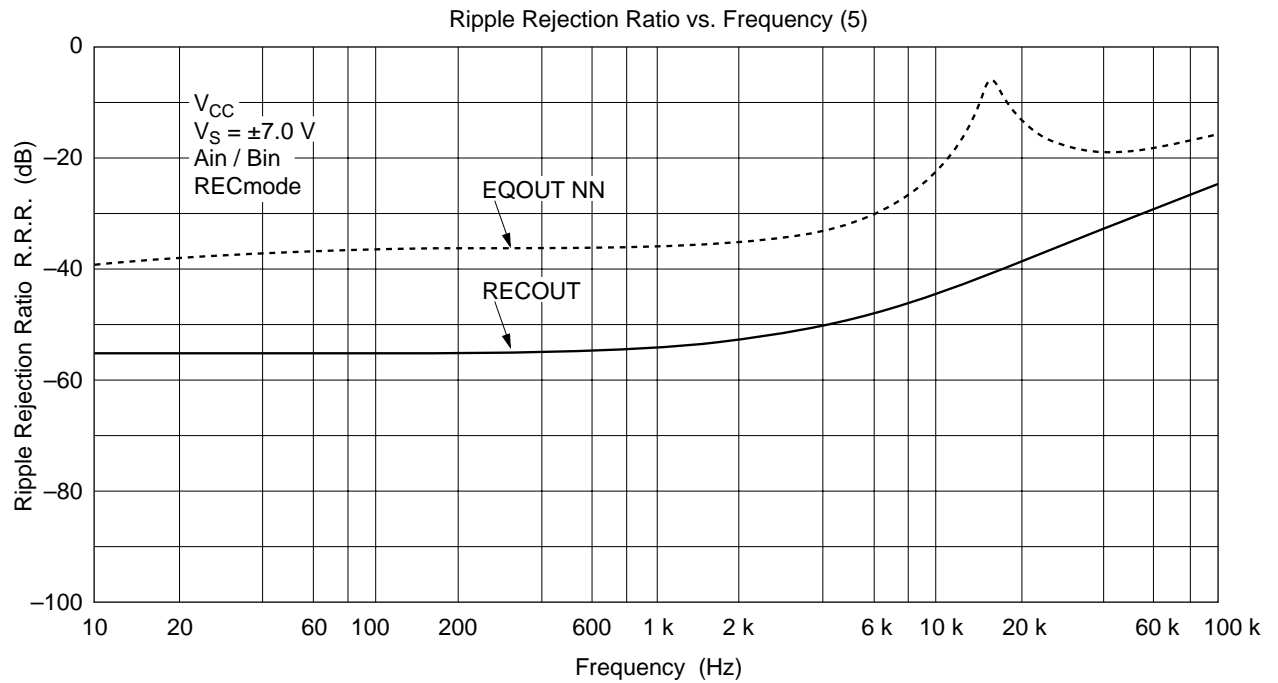
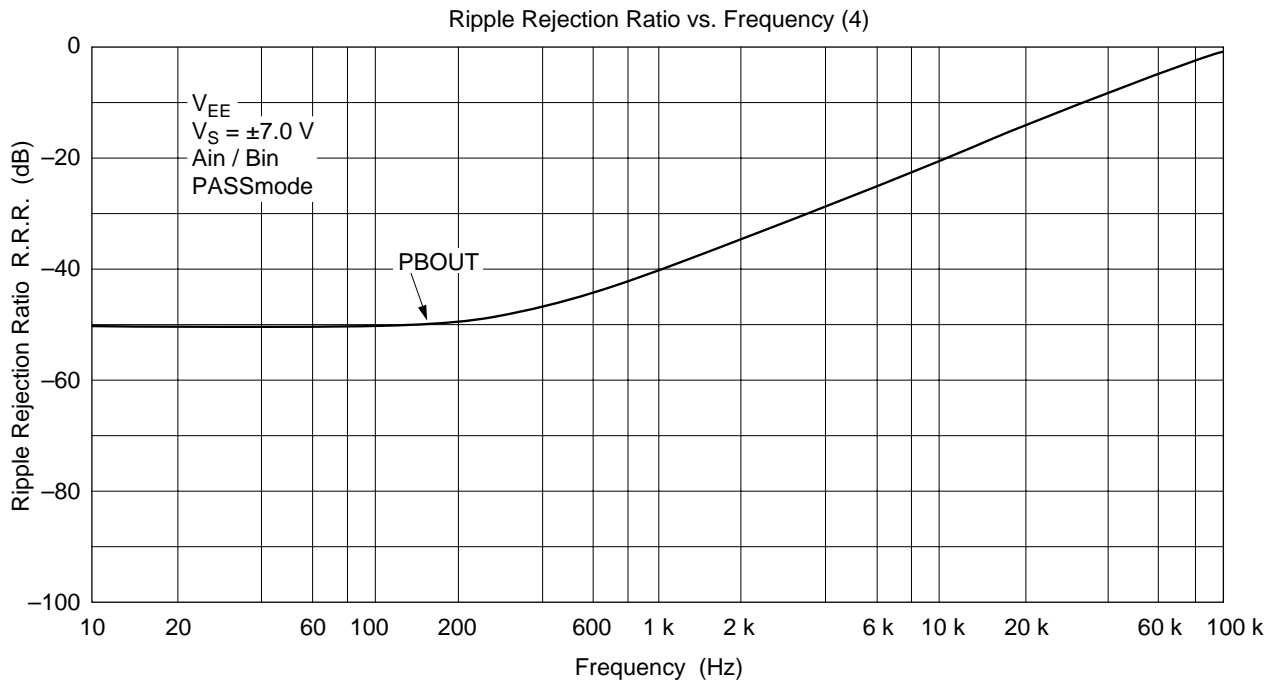

HA12203NT/HA12204NT

HA12204NT

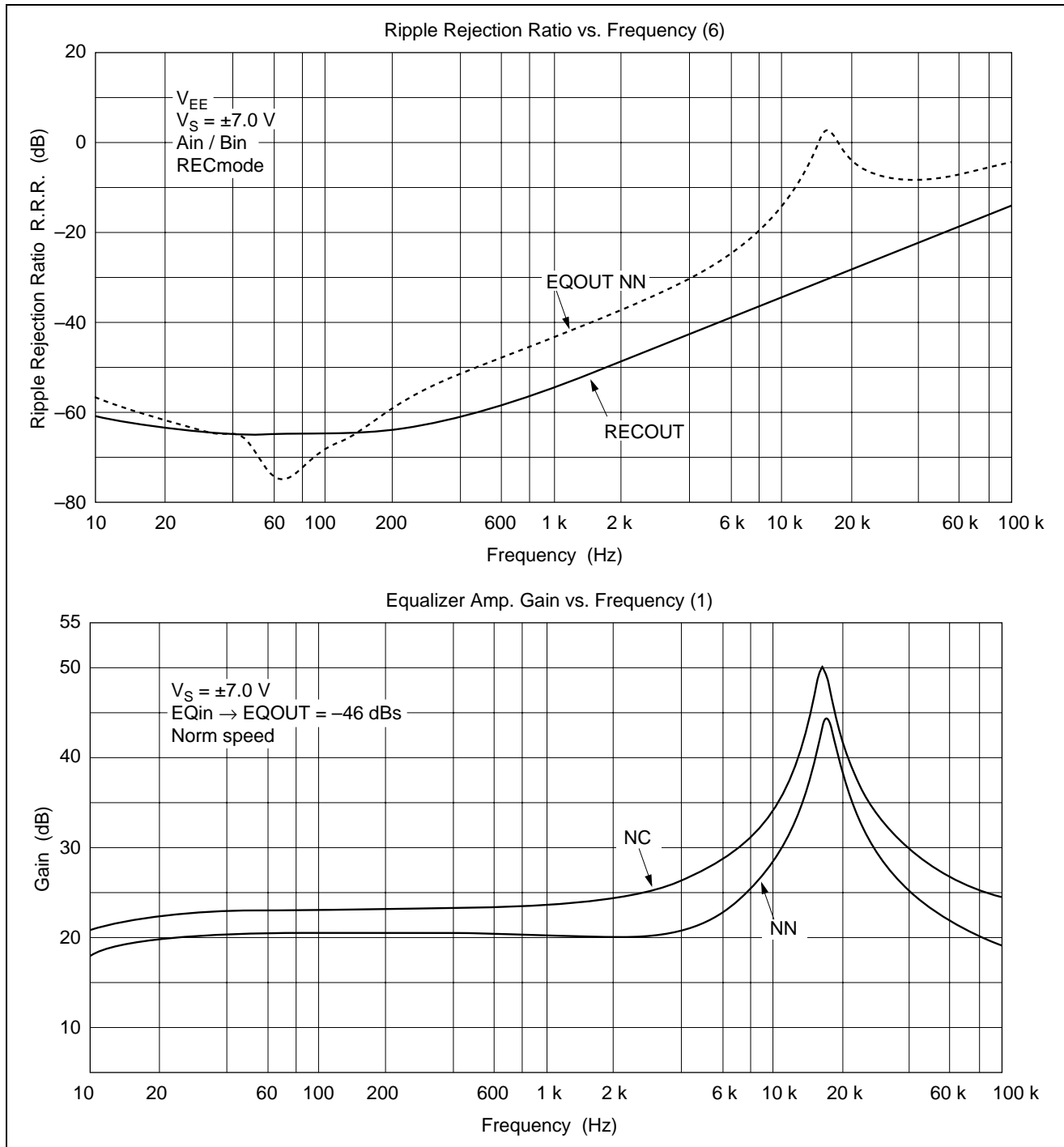

HA12204NT

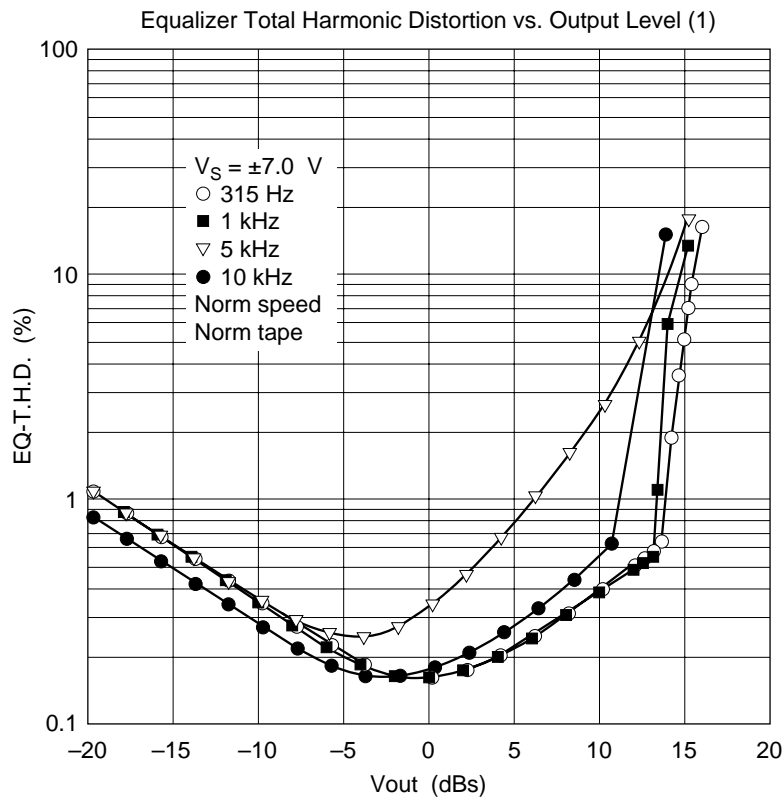
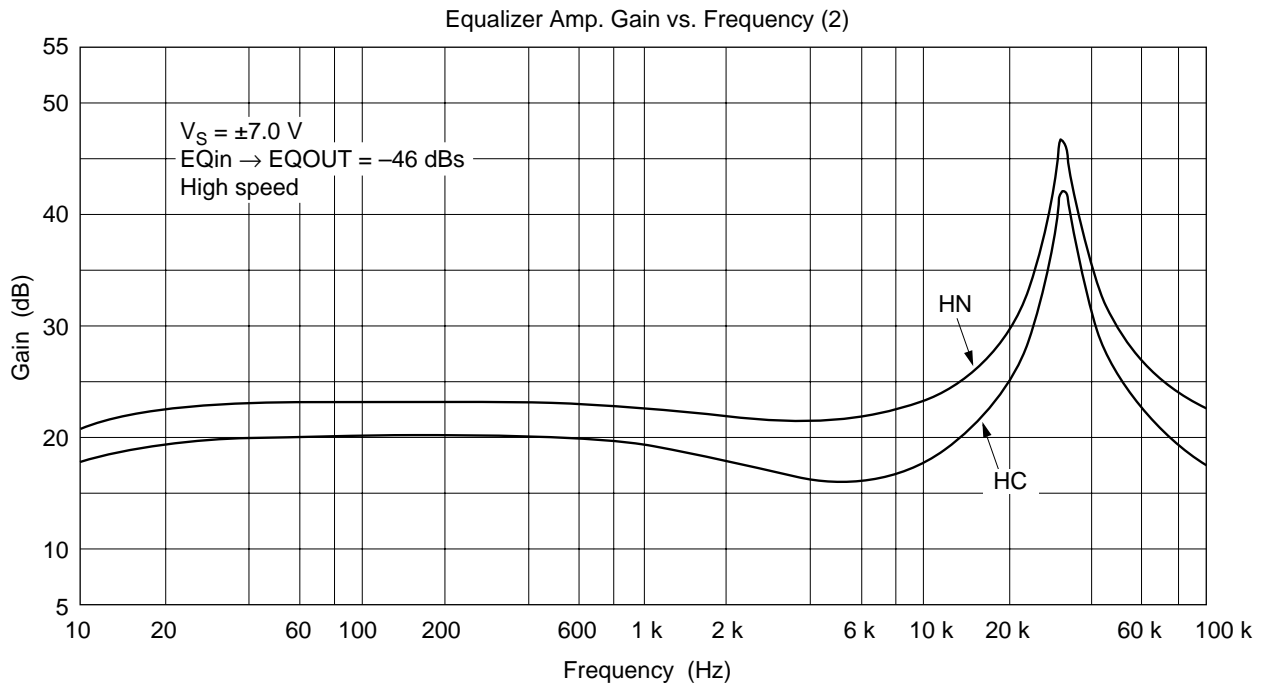

HA12204NT

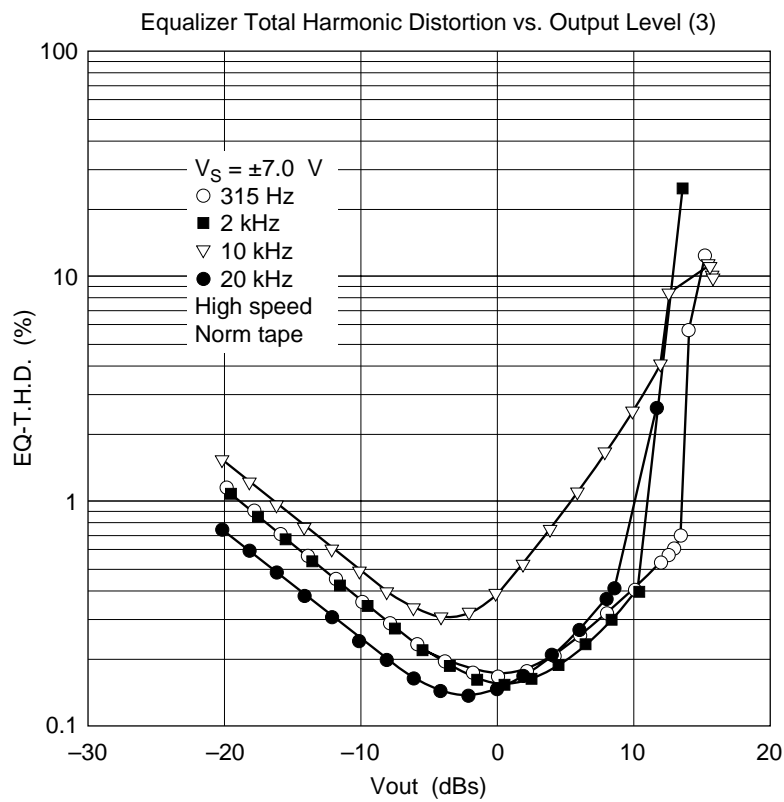
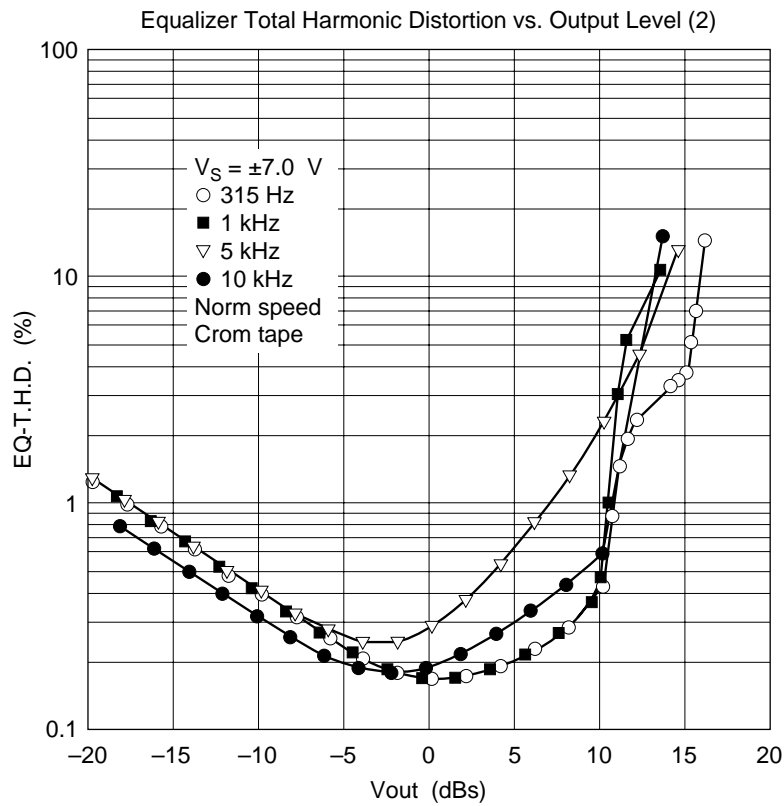

HA12204NT

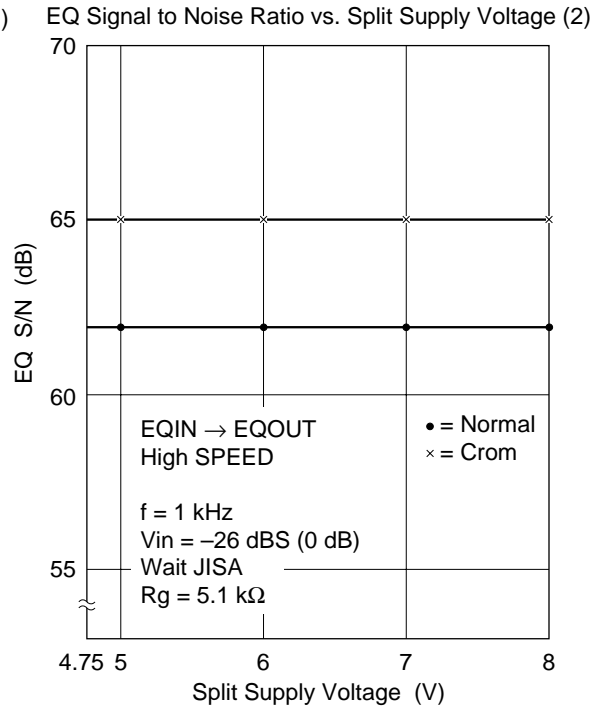
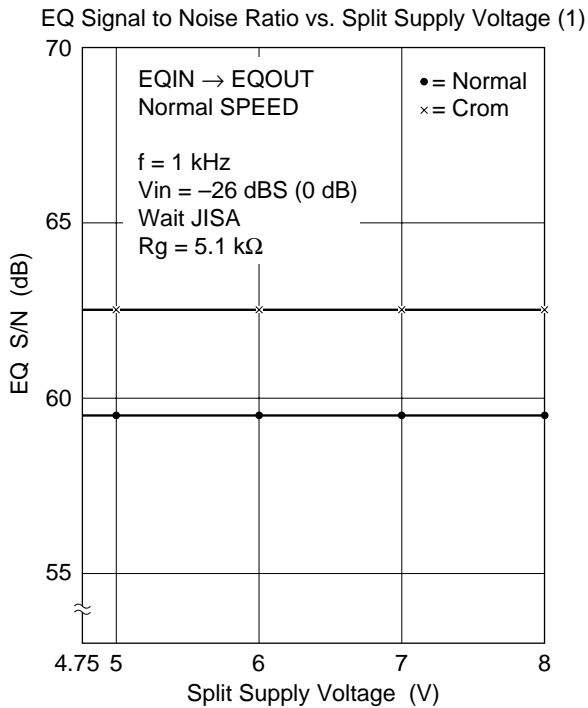
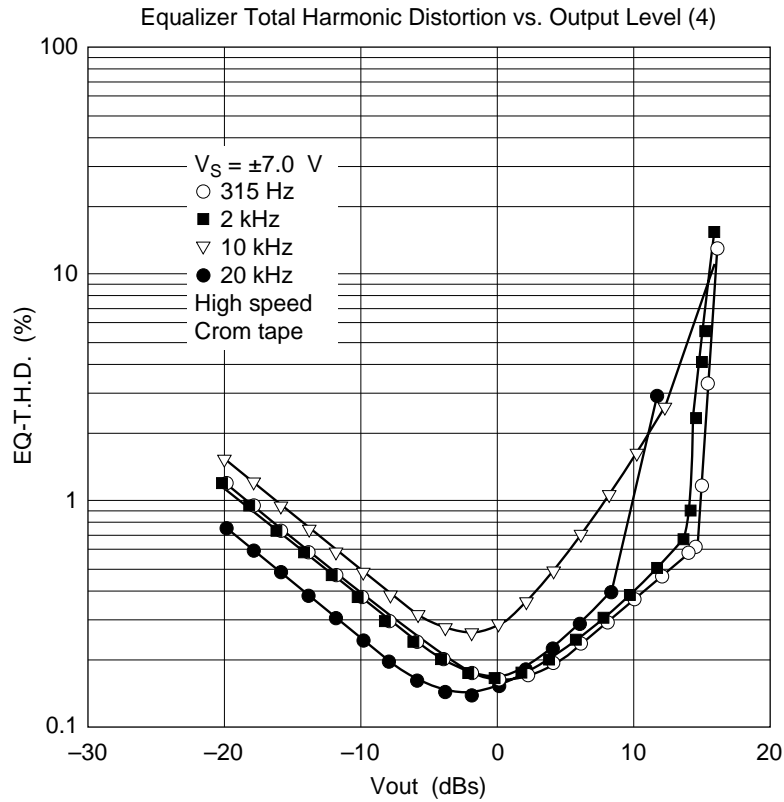

HA12204NT

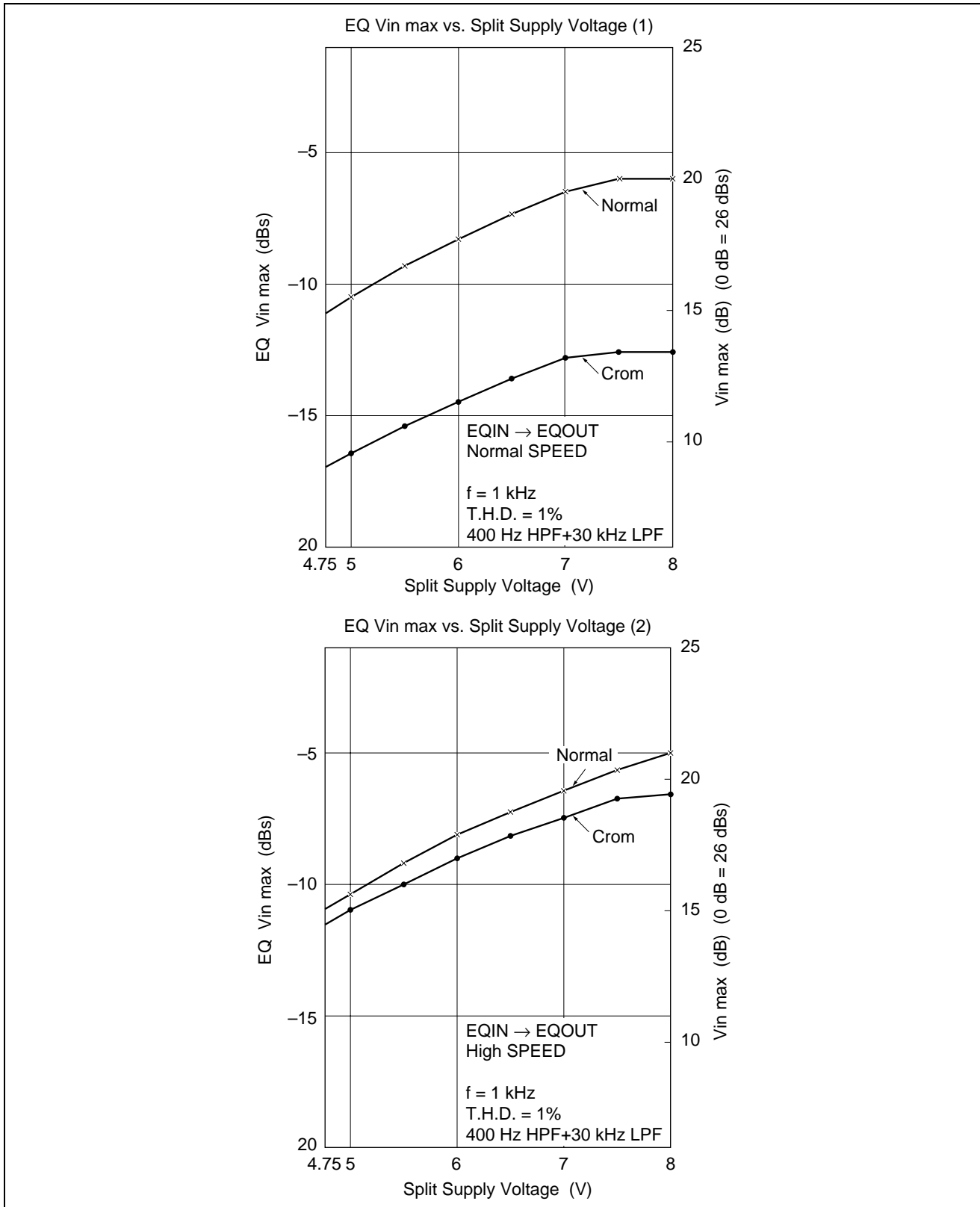

HA12204NT

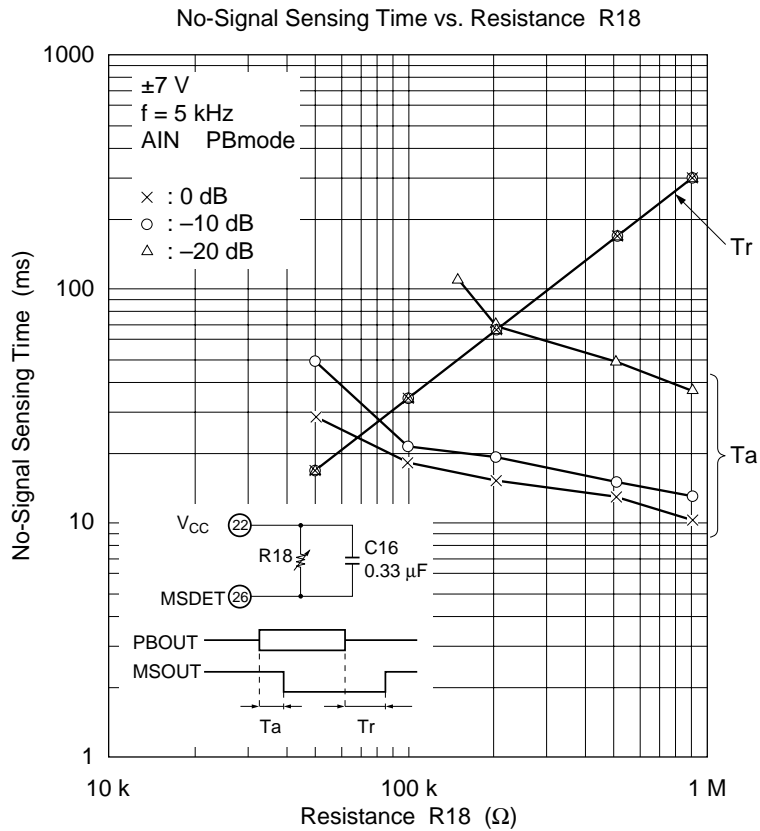
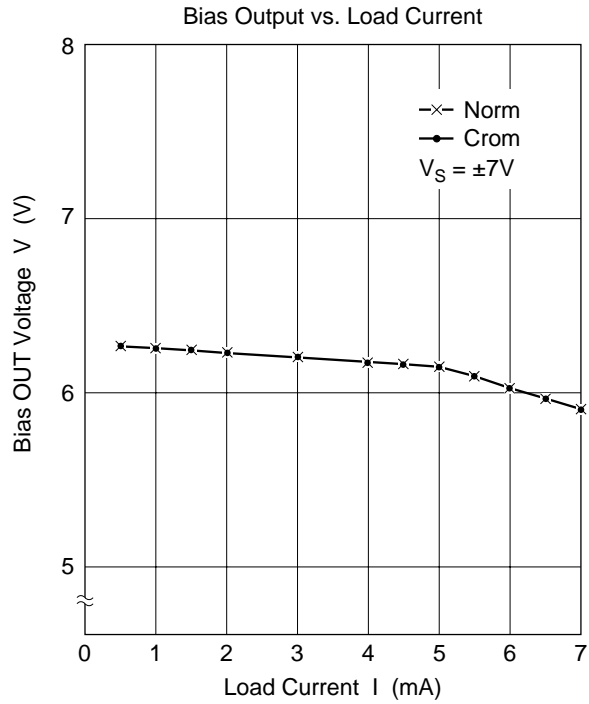

HA12204NT

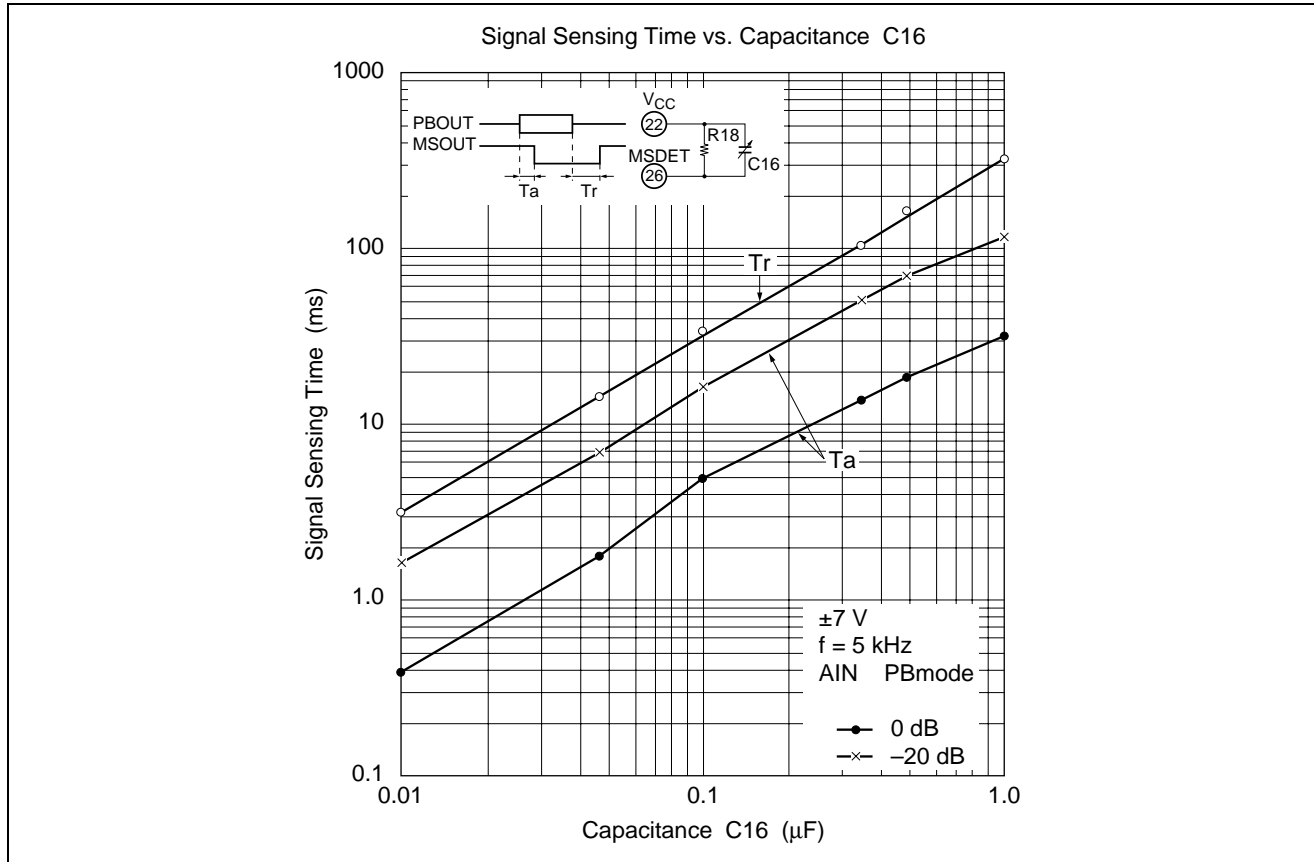

HA12204NT

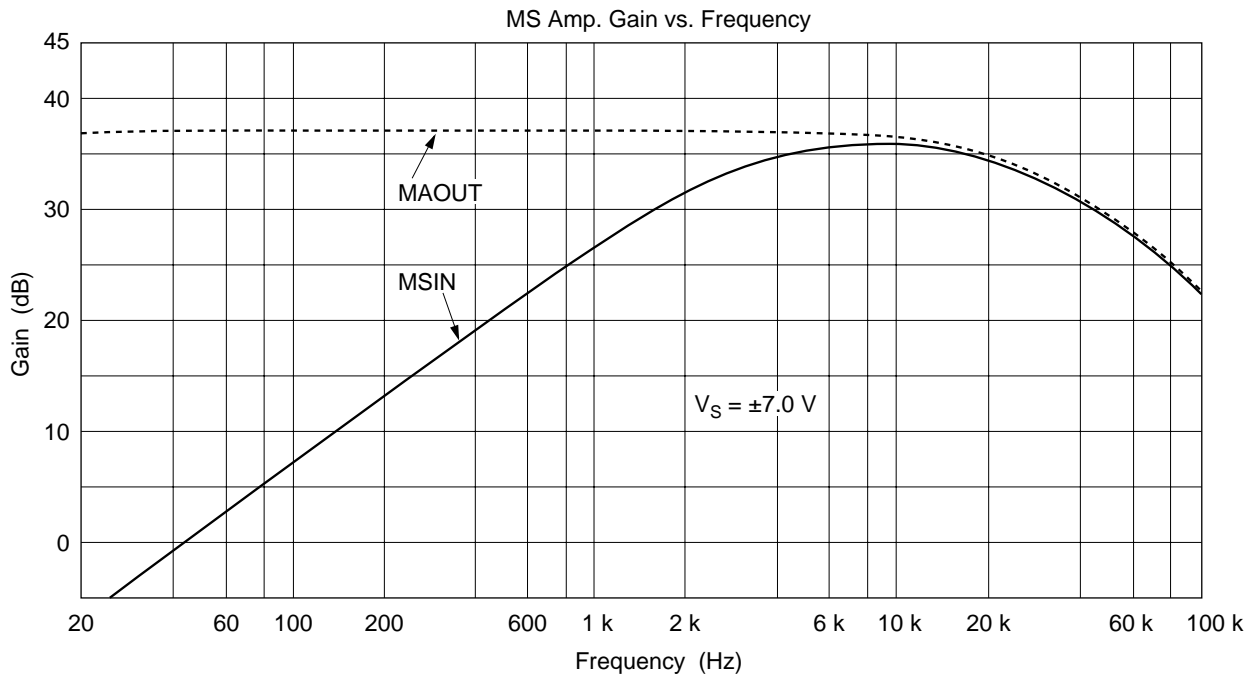
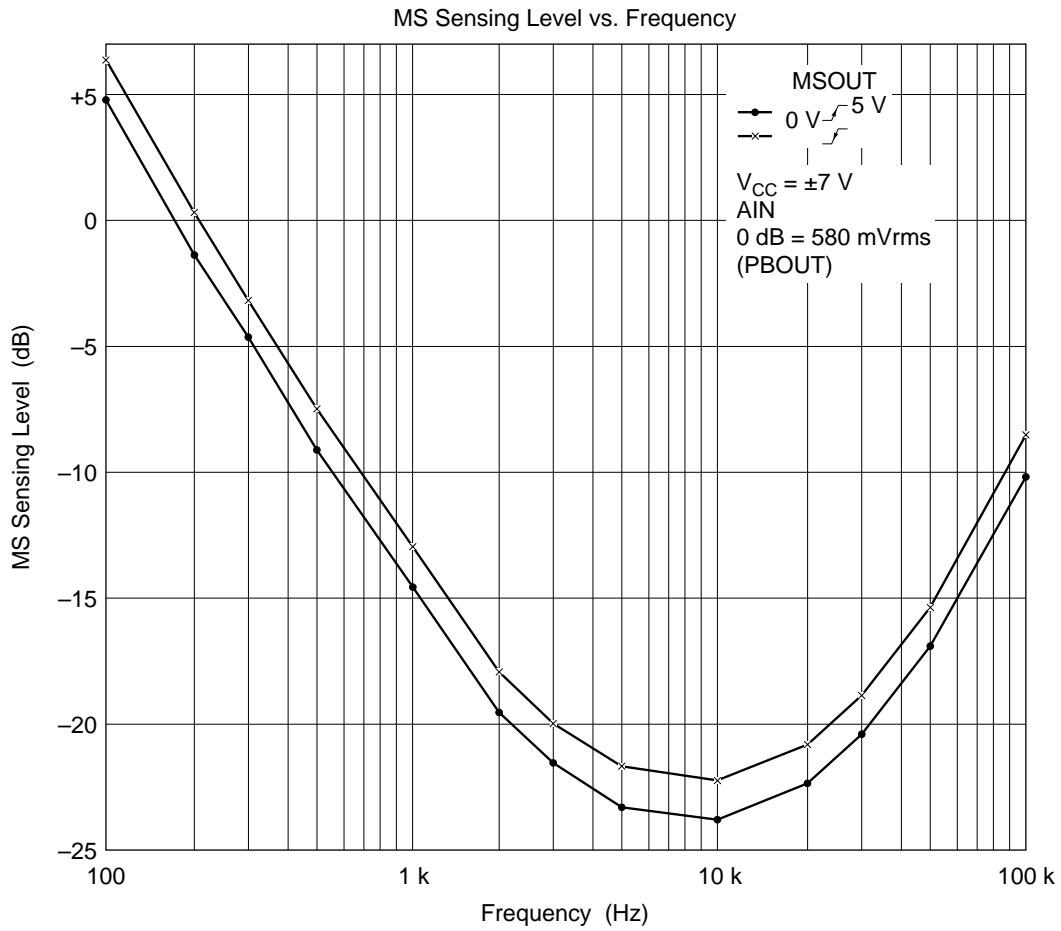

HA12203NT/HA12204NT

Package Dimensions

Unit: mm

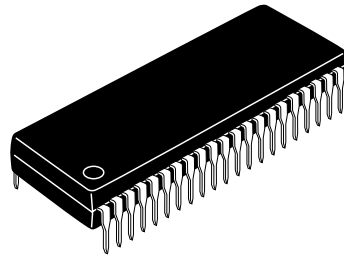
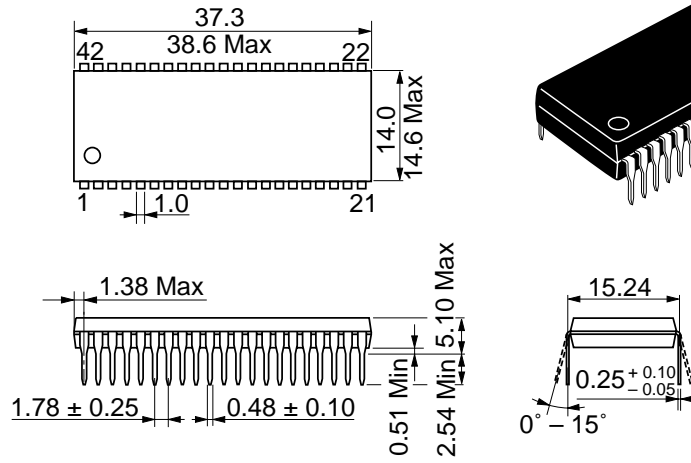

Hitachi Code	DP-42S
JEDEC	—
EIAJ	Conforms
Weight (reference value)	4.8 g

Disclaimer

1. Hitachi neither warrants nor grants licenses of any rights of Hitachi's or any third party's patent, copyright, trademark, or other intellectual property rights for information contained in this document. Hitachi bears no responsibility for problems that may arise with third party's rights, including intellectual property rights, in connection with use of the information contained in this document.
2. Products and product specifications may be subject to change without notice. Confirm that you have received the latest product standards or specifications before final design, purchase or use.
3. Hitachi makes every attempt to ensure that its products are of high quality and reliability. However, contact Hitachi's sales office before using the product in an application that demands especially high quality and reliability or where its failure or malfunction may directly threaten human life or cause risk of bodily injury, such as aerospace, aeronautics, nuclear power, combustion control, transportation, traffic, safety equipment or medical equipment for life support.
4. Design your application so that the product is used within the ranges guaranteed by Hitachi particularly for maximum rating, operating supply voltage range, heat radiation characteristics, installation conditions and other characteristics. Hitachi bears no responsibility for failure or damage when used beyond the guaranteed ranges. Even within the guaranteed ranges, consider normally foreseeable failure rates or failure modes in semiconductor devices and employ systemic measures such as fail-safes, so that the equipment incorporating Hitachi product does not cause bodily injury, fire or other consequential damage due to operation of the Hitachi product.
5. This product is not designed to be radiation resistant.
6. No one is permitted to reproduce or duplicate, in any form, the whole or part of this document without written approval from Hitachi.
7. Contact Hitachi's sales office for any questions regarding this document or Hitachi semiconductor products.

Sales Offices

HITACHI

Hitachi, Ltd.

Semiconductor & Integrated Circuits.
Nippon Bldg., 2-6-2, Ohte-machi, Chiyoda-ku, Tokyo 100-0004, Japan
Tel: Tokyo (03) 3270-2111 Fax: (03) 3270-5109

URL North America : <http://semiconductor.hitachi.com/>
 Europe : <http://www.hitachi-eu.com/hel/ecg>
 Asia : <http://sicapac.hitachi-asia.com>
 Japan : <http://www.hitachi.co.jp/Sicd/indx.htm>

For further information write to:

Hitachi Semiconductor
(America) Inc.
179 East Tasman Drive,
San Jose, CA 95134
Tel: <1> (408) 433-1990
Fax: <1>(408) 433-0223

Hitachi Europe GmbH
Electronic Components Group
Dornacher StraÙe 3
D-85622 Feldkirchen, Munich
Germany
Tel: <49> (89) 9 9180-0
Fax: <49> (89) 9 29 30 00

Hitachi Europe Ltd.
Electronic Components Group.
Whitebrook Park
Lower Cookham Road
Maidenhead
Berkshire SL6 8YA, United Kingdom
Tel: <44> (1628) 585000
Fax: <44> (1628) 585160

Hitachi Asia Ltd.
Hitachi Tower
16 Collyer Quay #20-00,
Singapore 049318
Tel : <65>-538-6533/538-8577
Fax : <65>-538-6933/538-3877
URL : <http://www.hitachi.com.sg>

Hitachi Asia Ltd.
(Taipei Branch Office)
4/F, No. 167, Tun Hwa North Road,
Hung-Kuo Building,
Taipei (105), Taiwan
Tel : <886>-(2)-2718-3666
Fax : <886>-(2)-2718-8180
Telex : 23222 HAS-TP
URL : <http://www.hitachi.com.tw>

Hitachi Asia (Hong Kong) Ltd.
Group III (Electronic Components)
7/F., North Tower,
World Finance Centre,
Harbour City, Canton Road
Tsim Sha Tsui, Kowloon,
Hong Kong
Tel : <852>-(2)-735-9218
Fax : <852>-(2)-730-0281
URL : <http://www.hitachi.com.hk>

Copyright © Hitachi, Ltd., 2000. All rights reserved. Printed in Japan.
Colophon 2.0