

## HAT1020R

Silicon P Channel Power MOS FET  
High Speed Power Switching

# HITACHI

ADE-208-435 F (Z)  
7th. Edition  
December. 1996

### Features

- Low on-resistance
- Capable of 4 V gate drive
- Low drive current
- High density mounting

### Outline

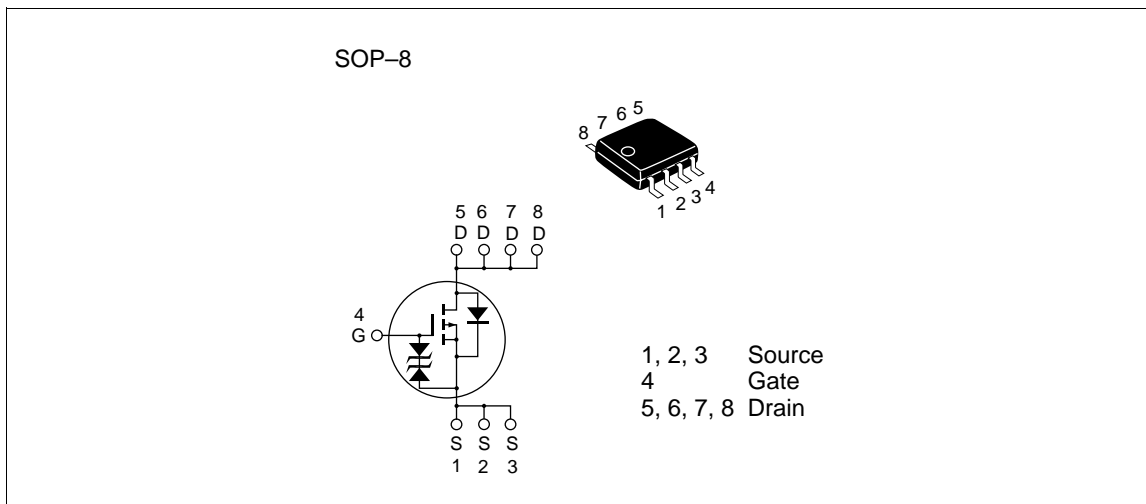

## HAT1020R

### Absolute Maximum Ratings (Ta = 25°C)

Item	Symbol	Ratings	Unit
Drain to source voltage	VDSS	-30	V
Gate to source voltage	VGSS	±20	V
Drain current	ID	-5	A
Drain peak current	ID(pulse)Note1	-40	A
Body-drain diode reverse drain current	IDR	-5	A
Channel dissipation	Pch Note2	2.5	W
Channel temperature	Tch	150	°C
Storage temperature	Tstg	-55 to +150	°C

Note: 1.  $PW \leq 10\mu s$ , duty cycle  $\leq 1\%$   
 2. When using the glass epoxy board (FR4 40 x 40 x 1.6 mm),  $PW \leq 10s$

### Electrical Characteristics (Ta = 25°C)

Item	Symbol	Min	Typ	Max	Unit	Test Conditions
Drain to source breakdown voltage	V(BR)DSS	-30	—	—	V	ID = -10mA, VGS = 0
Gate to source breakdown voltage	V(BR)GSS	±20	—	—	V	IG = ±100μA, VDS = 0
Gate to source leak current	IGSS	—	—	±10	μA	VGS = ±16V, VDS = 0
Zero gate voltage drain current	IDSS	—	—	-10	μA	VDS = -30 V, VGS = 0
Gate to source cutoff voltage	VGS(off)	-1.0	—	-2.5	V	VDS = -10V, ID = -1mA
Static drain to source on state resistance	RDS(on)	—	0.04	0.07	Ω	ID = -3A, VGS = -10V Note3
	RDS(on)	—	0.07	0.13	Ω	ID = -3A, VGS = -4V Note3
Forward transfer admittance	yfs	5.0	7.5	—	S	ID = -3A, VDS = -10V Note3
Input capacitance	Ciss	—	860	—	pF	VDS = -10V
Output capacitance	Coss	—	560	—	pF	VGS = 0
Reverse transfer capacitance	Crss	—	165	—	pF	f = 1MHz
Turn-on delay time	td(on)	—	30	—	ns	VGS = -4V, ID = -3A
Rise time	tr	—	170	—	ns	VDD $\hat{A}$ -10V
Turn-off delay time	td(off)	—	40	—	ns	
Fall time	tf	—	65	—	ns	
Body-drain diode forward voltage	VDF	—	-0.9	-1.4	V	IF = -5A, VGS = 0 Note3
Body-drain diode reverse recovery time	trr	—	55	—	ns	IF = -5A, VGS = 0 diF/ dt =20A/μs

## HAT1020R

### Main Characteristics

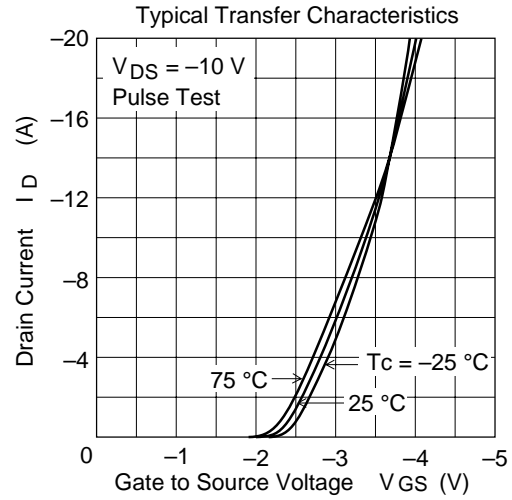
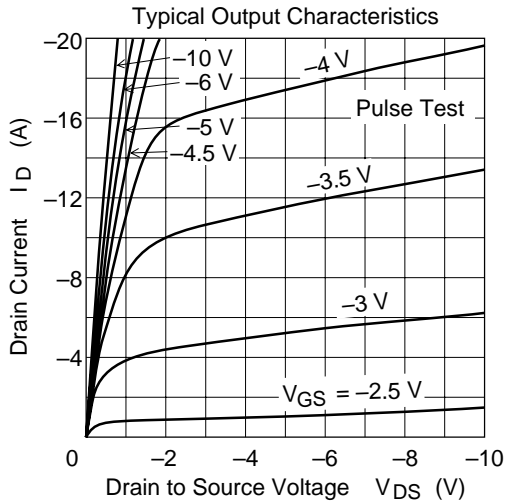
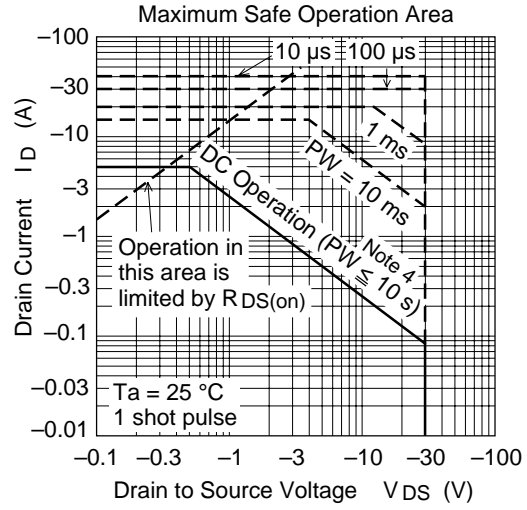
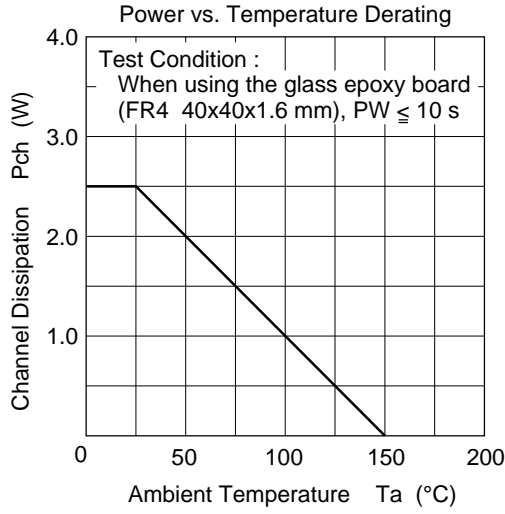

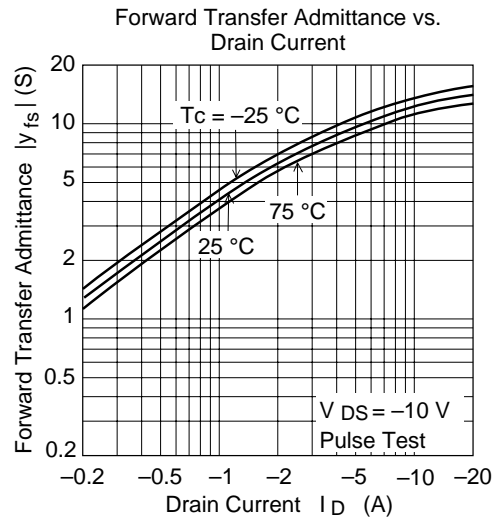
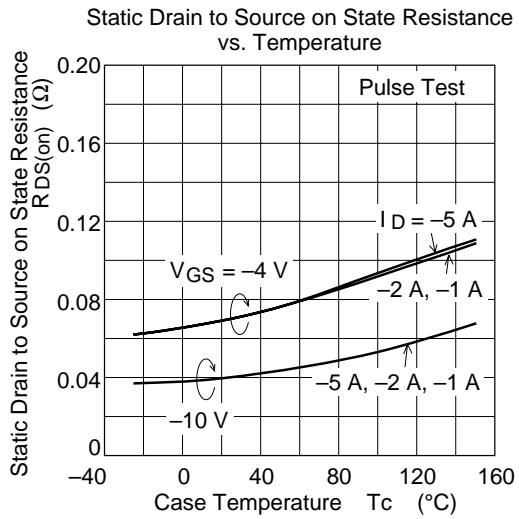
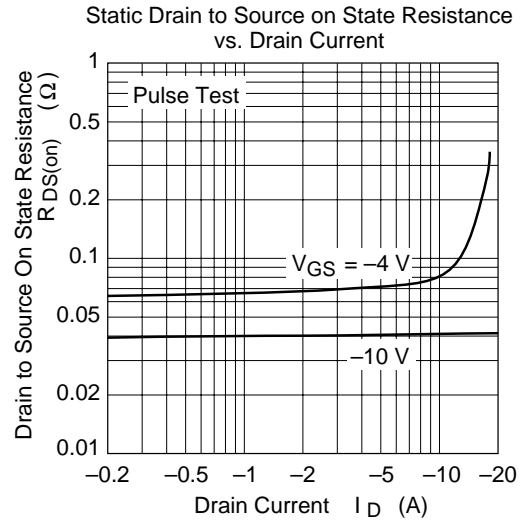
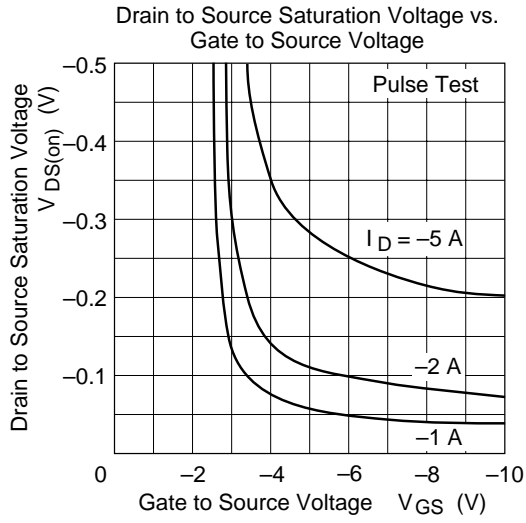

## HAT1020R

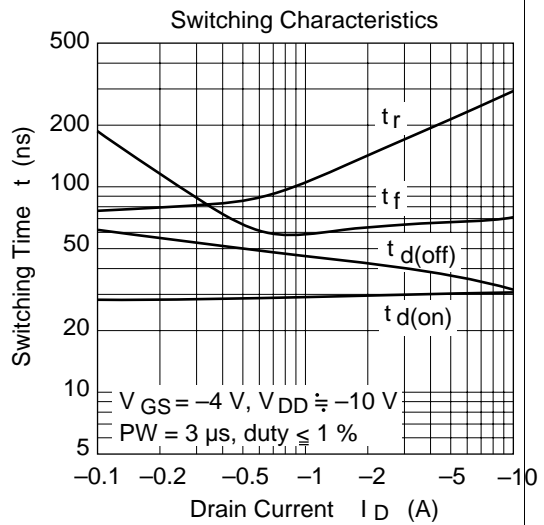
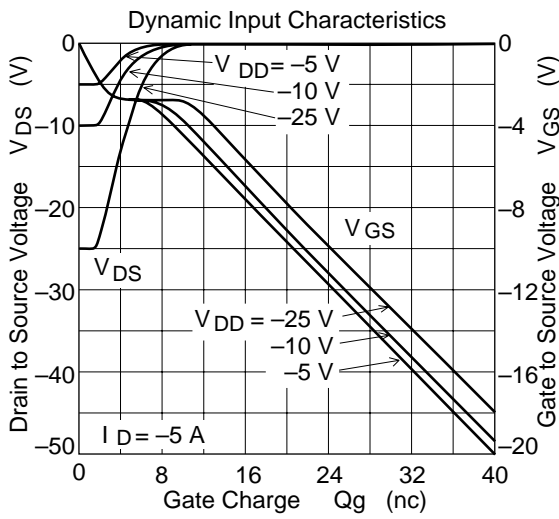
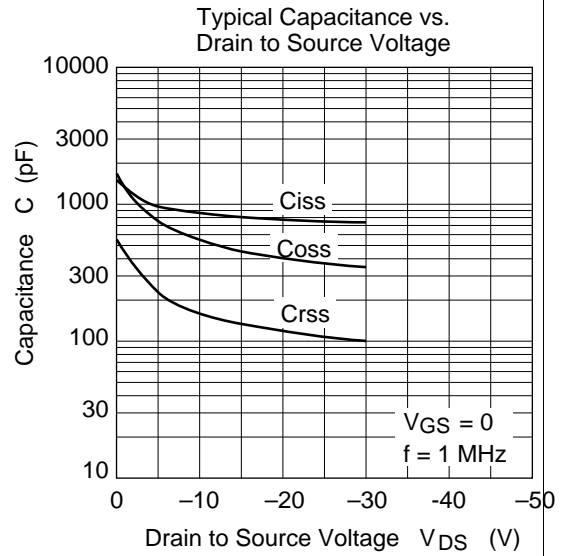
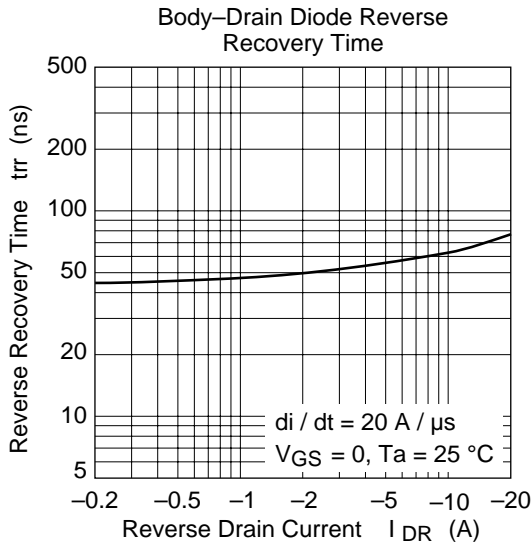

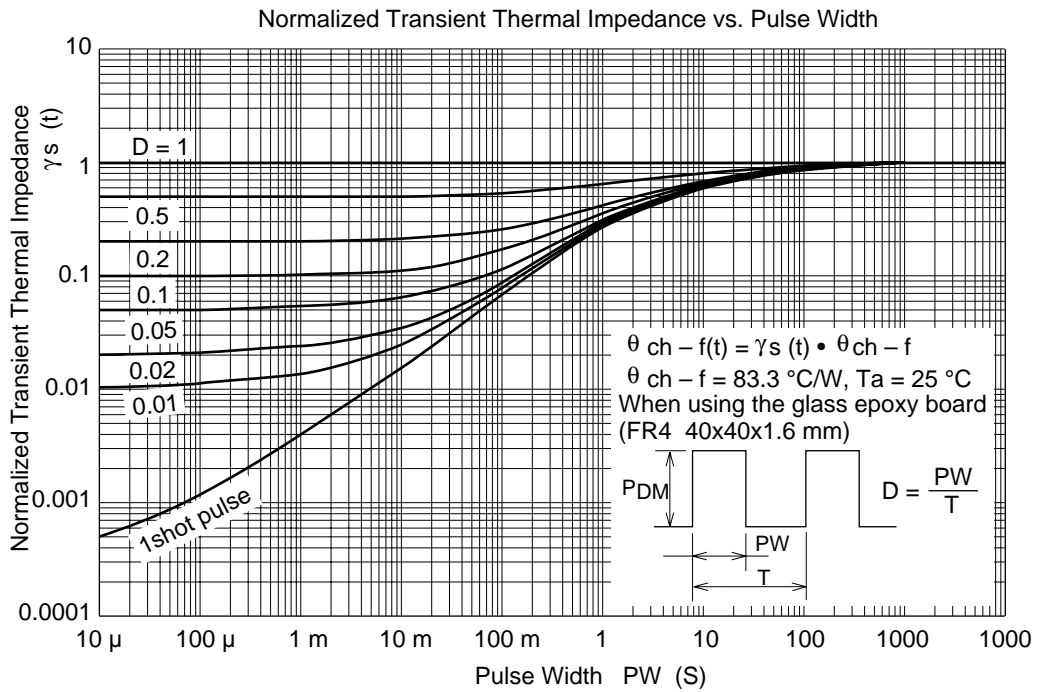
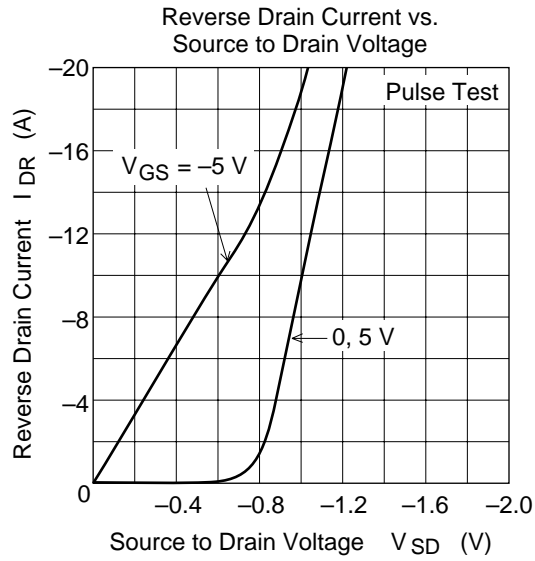

## HAT1020R

### Package Dimensions

Unit: mm

