

HRW0502A Silicon Schottky Barrier Diode for Rectifying

HITACHI

Rev. 4
Nov. 1994

Features

- Low forward voltage drop and suitable for high efficiency rectifying.
- MPAK package is suitable for high density surface mounting and high speed assembly.

Ordering Information

Type No.	Laser Mark	Package Code
HRW0502A	S10	MPAK

Pin Arrangement

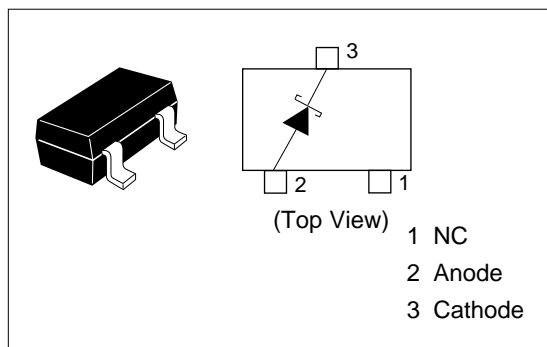

Absolute Maximum Ratings (Ta = 25°C)

Item	Symbol	Value	Unit
Repetitive peak reverse voltage	V_{RRM}^*	20	V
Average forward current	I_o^*	500	mA
Non-Repetitive peak forward surge current	I_{FSM}^{**}	5	A
Junction temperature	T_j	125	°C
Storage temperature	T_{stg}	-55 to +125	°C

* See Fig.4 & Fig.5

** 10msec half sine wave 1 pulse

Electrical Characteristics (Ta = 25°C)

Item	Symbol	Min	Typ	Max	Unit	Test Condition
Reverse current	I_R	—	—	200	μA	$V_R = 20 V$
Forward voltage	V_F	—	—	0.4	V	$I_F = 500 mA$
Capacitance	C	—	120	—	pF	$V_R = 0V, f = 1MHz$
Thermal resistance	$R_{th(j-a)}$	—	340	—	°C/W	Polyimide substrate *

* Polyimide PCB

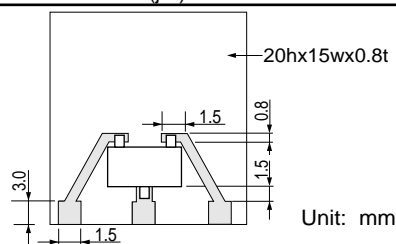

HRW0502A

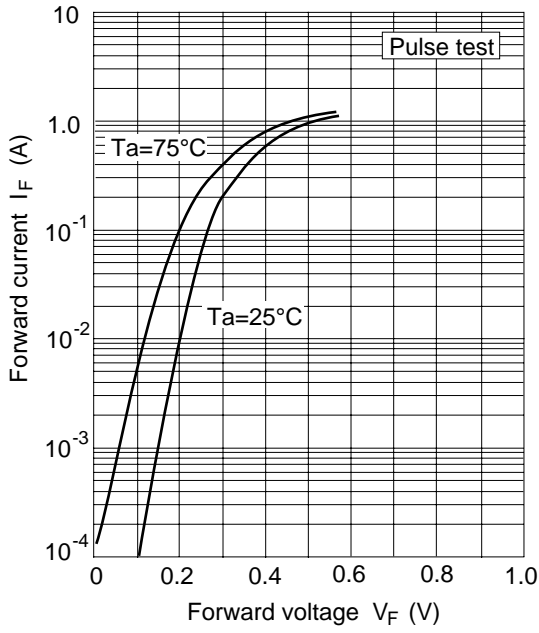

Fig.1 Forward current Vs. Forward voltage

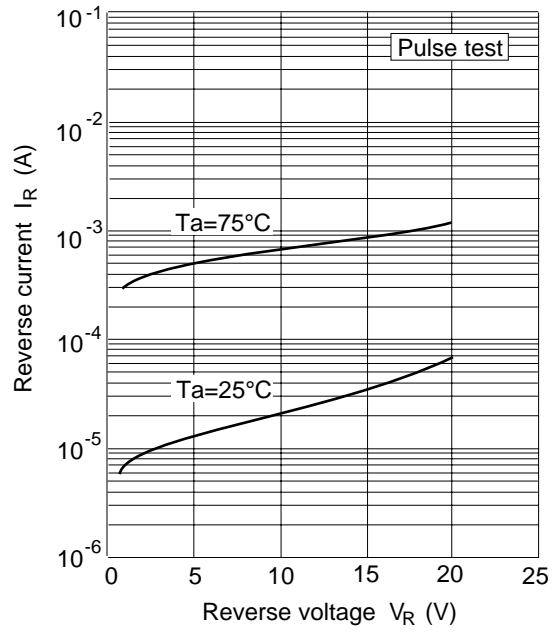

Fig.2 Reverse current Vs. Reverse voltage

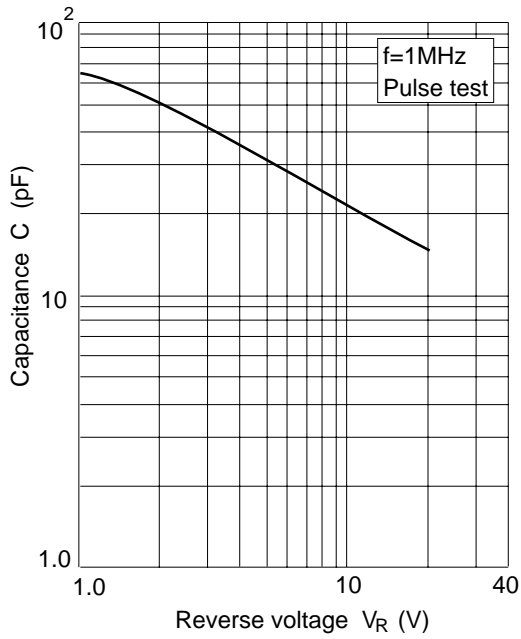

Fig.3 Capacitance Vs. Reverse voltage

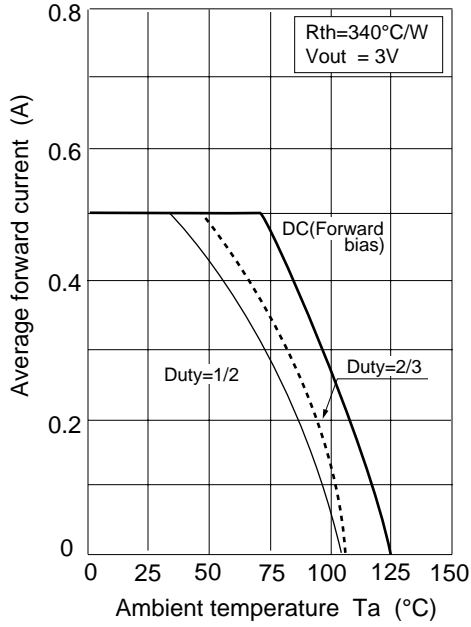

Fig.4 Average forward current Vs. Ambient temperature

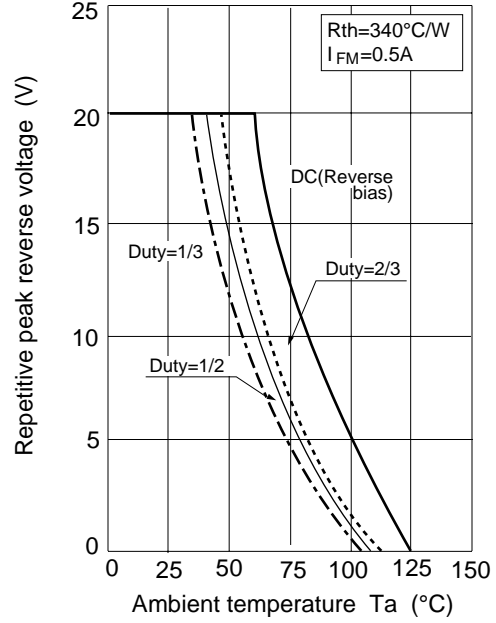
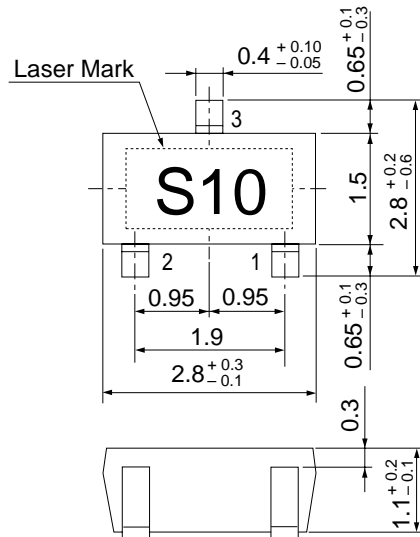

Fig.5 Repetitive peak reverse voltage Vs. Ambient temperature

Package Dimensions

Unit: mm



- 1 NC
- 2 Anode
- 3 Cathode

HITACHI Code	MPAK(1)
JEDEC Code	—
EIAJ Code	SC-59A
Weight (g)	0.011