

**PROGRAMMABLE SHUNT REGULATOR**

The LM431 Series are three-terminal adjustable regulator series with a guaranteed thermal stability over applicable temperature ranges. The output voltage may be set to any value between  $V_{REF}$  (approximately 2.5 volts) and 36 volts with two external resistors. These devices have a typical dynamic output impedance of  $0.2\Omega$ . Active output circuitry provides a very sharp turn-on characteristic, making these devices excellent replacement for zener diodes in many applications.

**FEATURES**

- Programmable output voltage to 36 volts
- Low dynamic output impedance 0.20 typical
- Sink current capability of 1.0 to 100mA
- Equivalent full-range temperature coefficient of 50ppm/°C typical
- Temperature compensated for operation over full rated operating temperature range
- Low output noise voltage
- Fast turn-on response

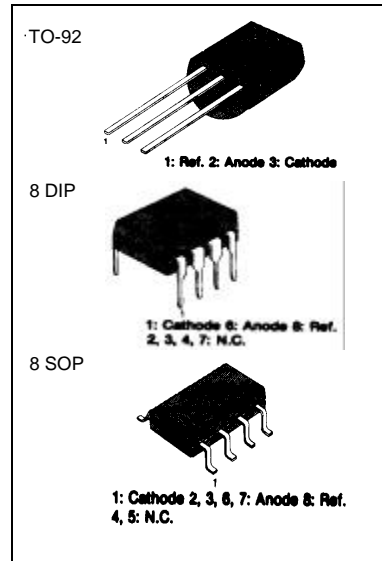

**ORDERING INFORMATION**

Device	Operating Temperature	Package
LM431ACZ (TL431CLP) (KA431Z)	-25 ~ + 85 °C	TO-92
TL431CP (KA431)	-25 ~ + 85 °C	8 DIP
LM431ACM (TL431CD) (KA431D)	-25 ~ + 85 °C	8 SOP
LM431BCZ (TL431ACL) (KA431AZ)	-25 ~ + 85 °C	TO-92
LM431BCM (TL431ACD) (KA431AD)	-25 ~ + 85 °C	8 SOP
LM431CCZ (KA431LZ)	-25 ~ + 85 °C	TO-92

**BLOCK DIAGRAM**

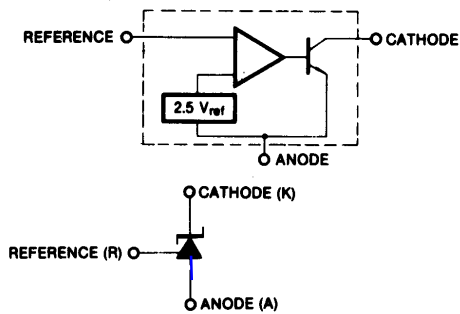

**ABSOLUTE MAXIMUM RATINGS**

(Operating temperature range applies unless otherwise specified.)

Characteristic	Symbol	Value	Unit
Cathode Voltage	$V_{KA}$	37	V
Cathode current Range (Continuous)	$I_{KA}$	-100 ~ + 150	mA
Reference Input Current Range	$I_{REF}$	0.05 ~ + 10	mA
Power Dissipation D, Z Suffix Package	$P_D$	770	mW
N Suffix Package		1000	mW
Operating Temperature Range	$T_{OPR}$	-25 ~ + 85	°C
Storage Temperature Range	$T_{STG}$	-65 ~ + 150	°C

**RECOMMENDED OPERATING CONDITIONS**

Characteristic	Symbol	Min	Typ	Max	Unit
Cathode Voltage	$V_{KA}$	$V_{REF}$		36	V
Cathode Current	$I_{KA}$	1.0		100	mA

**ELECTRICAL CHARACTERISTICS** ( $T_A = +25^\circ\text{C}$ , unless otherwise specified)

Characteristic	Symbol	Test Conditions	TL431			TL431A			TL431L			Unit
			Min	Typ	Max	Min	Typ	Max	Min	Typ	Max	
Reference Input Voltage	$V_{REF}$	$V_{KA}=V_{REF}, I_{KA}=10\text{mA}$	2.440	2.495	2.550	2.470	2.495	2.520	2.482	2.495	2.508	V
Deviation of Reference Input Voltage Over-Temperature (Note 1)	$DV_{REF}/DT$	$V_{KA}=V_{REF}, I_{KA}=10\text{mA}$ $T_{MIN} \leq T_A \leq T_{MAX}$		4.5	17		4.5	17		4.5	17	mV
Ratio of Change in Reference Input Voltage to the Change in Cathode Voltage	$DV_{REF}/DI_{KA}$	$I_{KA}=10\text{mA}$										mV/W
		$DI_{KA}=10\text{V}-V_{REF}$		-10	-2.7		-1.0	-2.7		-1.0	-2.7	
		$DI_{KA}=36\text{V}-10\text{V}$		-0.5	-2.0		-0.5	-2.0		-0.5	-2.0	
Reference Input Current	$I_{REF}$	$I_{KA}=10\text{mA}, R_1=10\text{K}\Omega, R_2=\infty$	1.5	4		1.5	4		1.5	4		$\mu\text{A}$
Deviation of Reference Input Current Over Full Temperature Range	$DI_{REF}/DT$	$I_{KA}=10\text{mA}, R_1=10\text{K}\Omega, R_2=\infty$ $T_A = \text{Full Range}$		0.4	1.2		0.4	1.2		0.4	1.2	$\mu\text{A}$
Minimum Cathode Current for Regulation	$I_{KA(MIN)}$	$V_{KA}=V_{REF}$		0.45	1.0		0.45	1.0		0.45	1.0	mA
Off - Stage Cathode Current	$I_{KA(OFF)}$	$V_{KA}=36\text{V}, V_{REF}=0$		0.05	1.0		0.05	1.0		0.05	1.0	$\mu\text{A}$
Dynamic Impedance (Note 2)	$Z_{KA}$	$V_{KA}=V_{REF}, I_{KA}=1 \text{ to } 100\text{mA}$ f 1.0K $\Omega$		0.15	0.5		0.15	0.5		0.15	0.5	$\Omega$

 $T_{MIN} = -25^\circ\text{C}$ ,  $T_{MAX} = +85^\circ\text{C}$

## TEST CIRCUITS

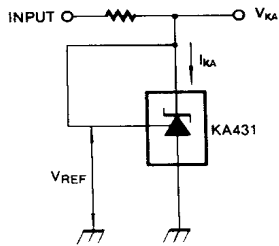
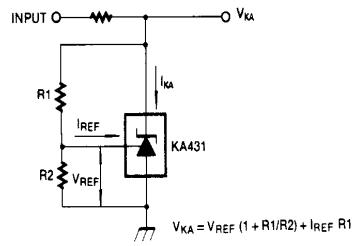
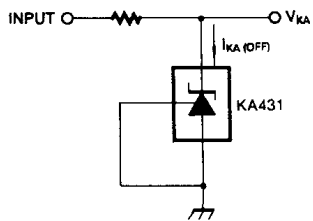
Fig. 1 Test Circuit for  $V_{KA} = V_{REF}$ Fig. 2 Test Circuit for  $V_{KA} \geq V_{REF}$ Fig. 3 Test Circuit for  $I_{KA(OFF)}$ 

TYPICAL PERFORMANCE CHARACTERISTICS

Fig. 4 Cathode Current vs. Cathode Voltage

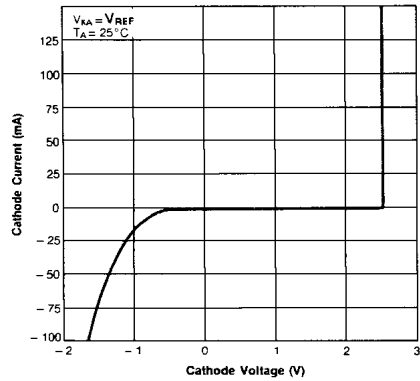

Fig. 5 Cathode Current vs. Cathode Voltage

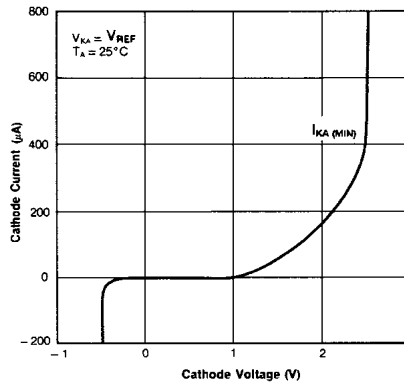

Fig. 6 Change In Reference Input Voltage vs. Cathode Voltage

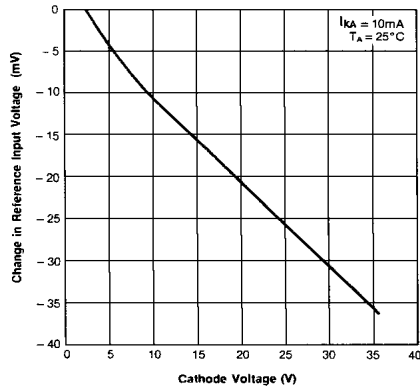

Fig. 7 Dynamic Impedance Frequency

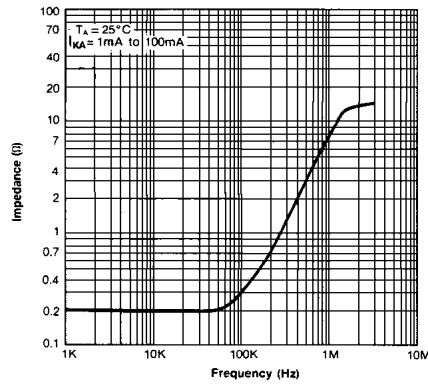

Fig. 8 Small Signal Voltage Amplification vs. Frequency

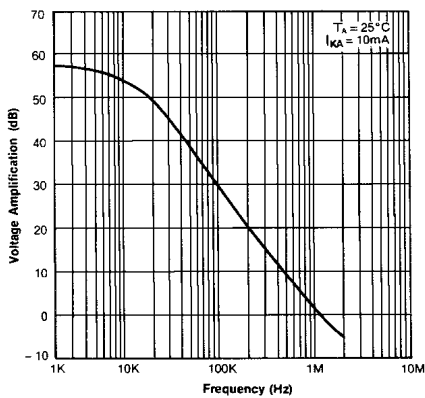
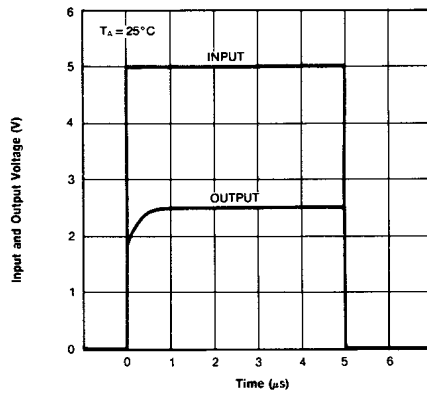

Fig. 9 Pulse Response



TYPICAL APPLICATIONS

Fig. 10 Shunt Regulator

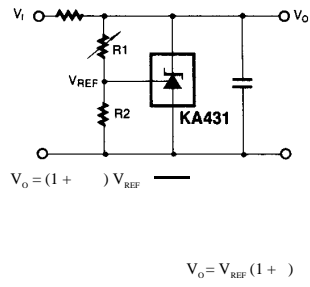

Fig.11 Output Control for a Three-Terminal Fixed Regulator

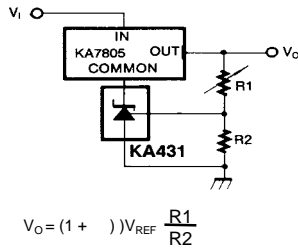

Fig.12 High Current Shunt Regulator

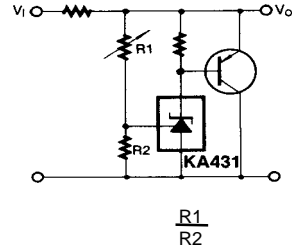

Fig. 13 Current Limit or Current Source

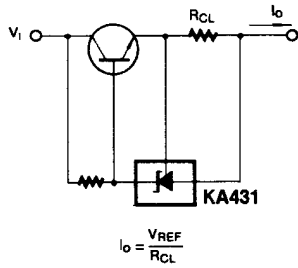
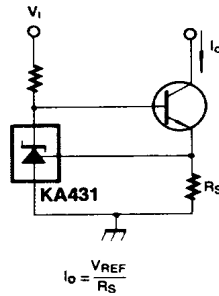

Fig. 14 Constant-Current Sink



## TRADEMARKS

The following are registered and unregistered trademarks Fairchild Semiconductor owns or is authorized to use and is not intended to be an exhaustive list of all such trademarks.

ACE <sub>x</sub> <sup>TM</sup>	ISOPLANAR <sup>TM</sup>	TinyLogic <sup>TM</sup>
CoolFET <sup>TM</sup>	MICROWIRE <sup>TM</sup>	UHC <sup>TM</sup>
CROSSVOLT <sup>TM</sup>	POP <sup>TM</sup>	VCX <sup>TM</sup>
E <sup>2</sup> CMOS <sup>TM</sup>	PowerTrench <sup>®</sup>	
FACT <sup>TM</sup>	QFET <sup>TM</sup>	
FACT Quiet Series <sup>TM</sup>	QS <sup>TM</sup>	
FAST <sup>®</sup>	Quiet Series <sup>TM</sup>	
FAST <sub>r</sub> <sup>TM</sup>	SuperSOT <sup>TM</sup> -3	
GTO <sup>TM</sup>	SuperSOT <sup>TM</sup> -6	
HiSeC <sup>TM</sup>	SuperSOT <sup>TM</sup> -8	

## DISCLAIMER

FAIRCHILD SEMICONDUCTOR RESERVES THE RIGHT TO MAKE CHANGES WITHOUT FURTHER NOTICE TO ANY PRODUCTS HEREIN TO IMPROVE RELIABILITY, FUNCTION OR DESIGN. FAIRCHILD DOES NOT ASSUME ANY LIABILITY ARISING OUT OF THE APPLICATION OR USE OF ANY PRODUCT OR CIRCUIT DESCRIBED HEREIN; NEITHER DOES IT CONVEY ANY LICENSE UNDER ITS PATENT RIGHTS, NOR THE RIGHTS OF OTHERS.

## LIFE SUPPORT POLICY

FAIRCHILD'S PRODUCTS ARE NOT AUTHORIZED FOR USE AS CRITICAL COMPONENTS IN LIFE SUPPORT DEVICES OR SYSTEMS WITHOUT THE EXPRESS WRITTEN APPROVAL OF FAIRCHILD SEMICONDUCTOR CORPORATION.  
As used herein:

1. Life support devices or systems are devices or systems which, (a) are intended for surgical implant into the body, or (b) support or sustain life, or (c) whose failure to perform when properly used in accordance with instructions for use provided in the labeling, can be reasonably expected to result in significant injury to the user.
2. A critical component is any component of a life support device or system whose failure to perform can be reasonably expected to cause the failure of the life support device or system, or to affect its safety or effectiveness.

## PRODUCT STATUS DEFINITIONS

### Definition of Terms

Datasheet Identification	Product Status	Definition
Advance Information	Formative or In Design	This datasheet contains the design specifications for product development. Specifications may change in any manner without notice.
Preliminary	First Production	This datasheet contains preliminary data, and supplementary data will be published at a later date. Fairchild Semiconductor reserves the right to make changes at any time without notice in order to improve design.
No Identification Needed	Full Production	This datasheet contains final specifications. Fairchild Semiconductor reserves the right to make changes at any time without notice in order to improve design.
Obsolete	Not In Production	This datasheet contains specifications on a product that has been discontinued by Fairchild semiconductor. The datasheet is printed for reference information only.