

SHINDENGEN

Schottky Rectifiers (SBD)

Single

M1FH3

30V 1.5A

OUTLINE DIMENSIONS

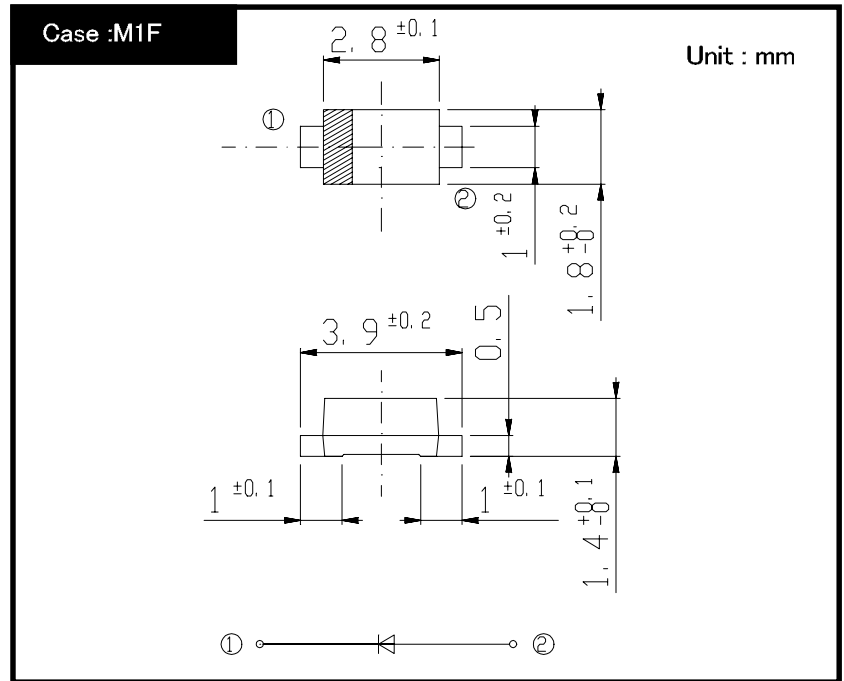

RATINGS

● Absolute Maximum Ratings (Tc=25°C)

Item	Symbol	Conditions	Ratings	Unit
Storage Temperature	Tstg		-55~125	°C
Operating Junction Temperature	Tj		125	°C
Maximum Reverse Voltage	V _{RM}		30	V
Average Rectified Forward Current	I _O	50Hz sine wave, R-load Tc=105°C	1.5	A
Peak Surge Forward Current	I _{FSM}	50Hz sine wave, Non-repetitive 1 cycle peak value, Tj=25°C	30	A

● Electrical Characteristics Tc=25°C

Item	Symbol	Conditions	Ratings	Unit
Forward Voltage	V _{F1}	I _F =0.5A, Pulse measurement	Max.0.30	V
	V _{F2}	I _F =1.5A, Pulse measurement	Max.0.36	
Reverse Current	I _R	V _R =V _{RM} , Pulse measurement	Max.1.0	mA
Junction Capacitance	C _j	f=1MHz, V _R =10V	Typ.80	pF
Thermal Resistance	θ _{jc}	junction to case	Max.18	°C/W
	θ _{jl}	junction to lead	Max.20	
	θ _{ja}	junction to ambient On glass-epoxy substrate	Max.80	

M1FH3

Forward Voltage

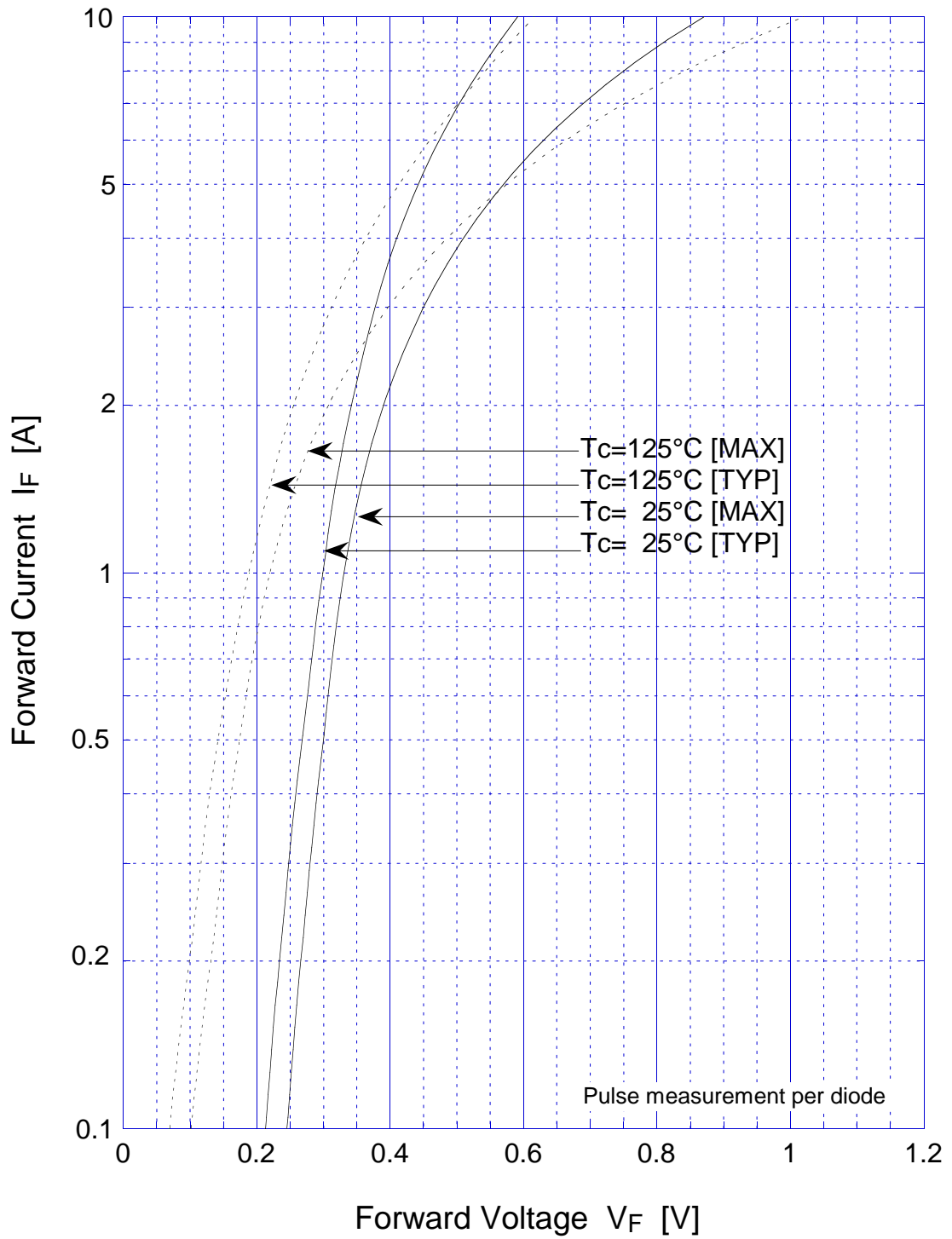

M1FH3 Forward Power Dissipation

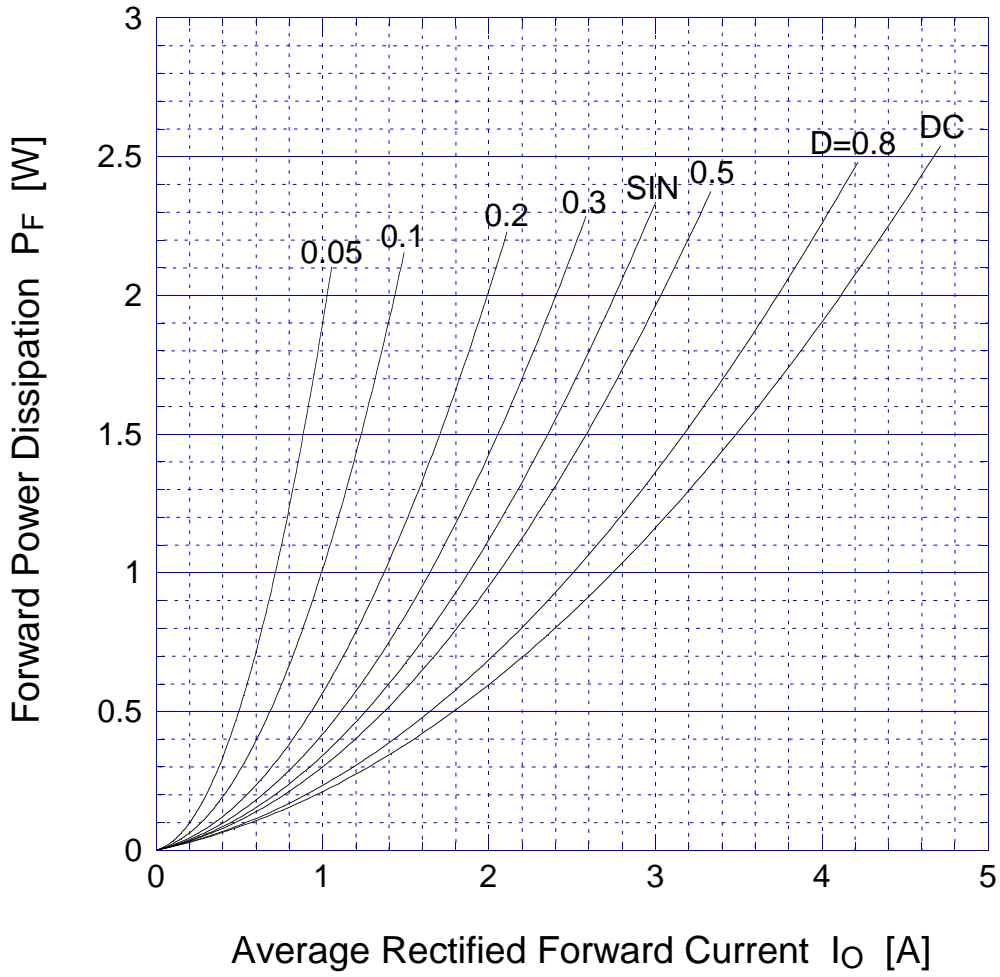

$T_j = 125^\circ\text{C}$

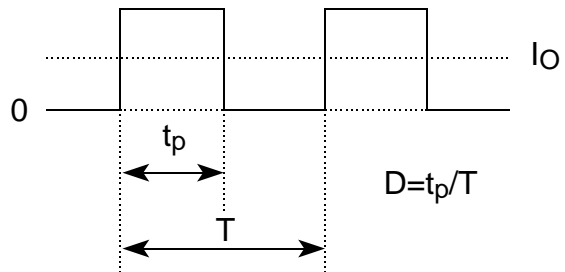

M1FH3

Peak Surge Forward Capability

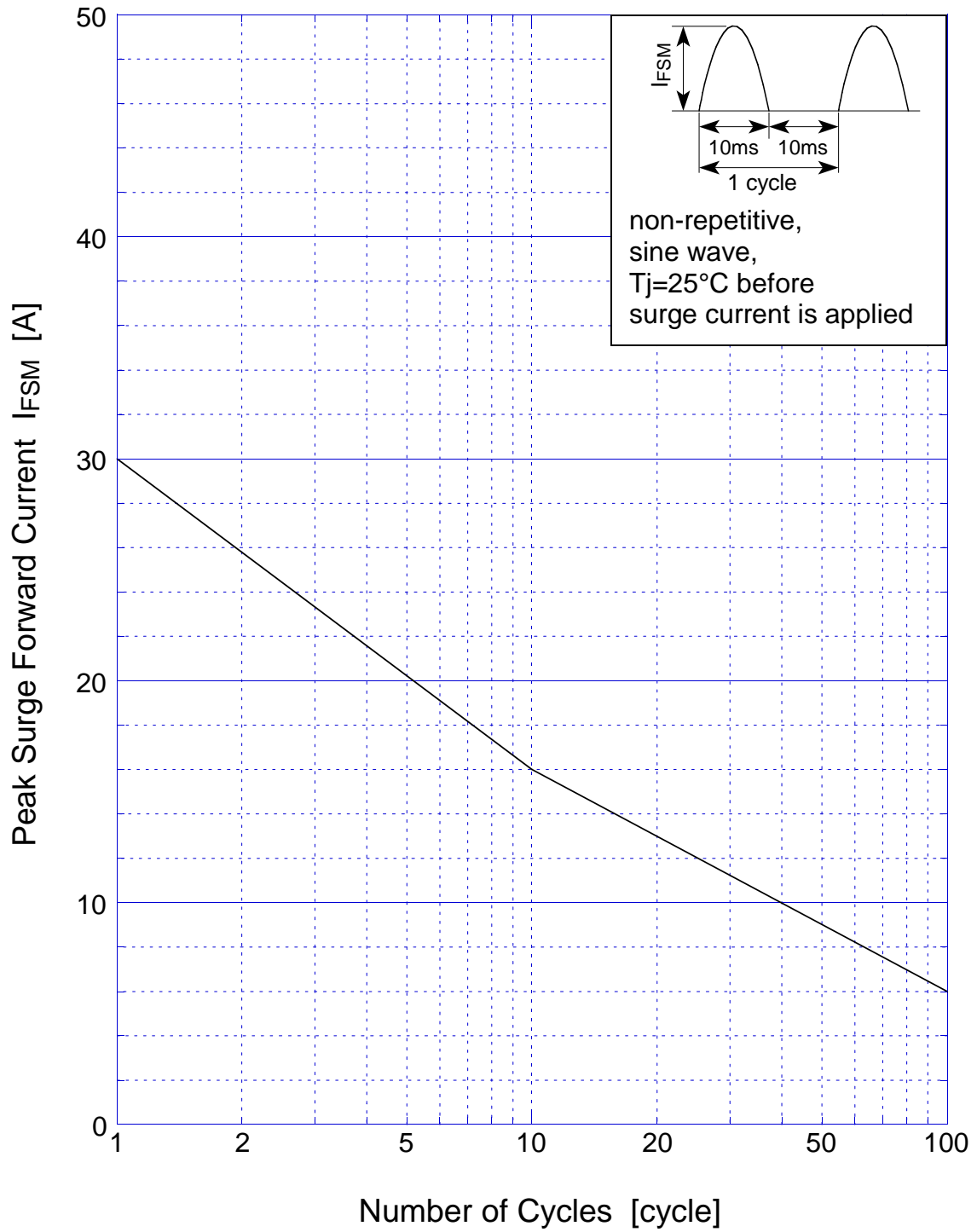

M1FH3

Reverse Current

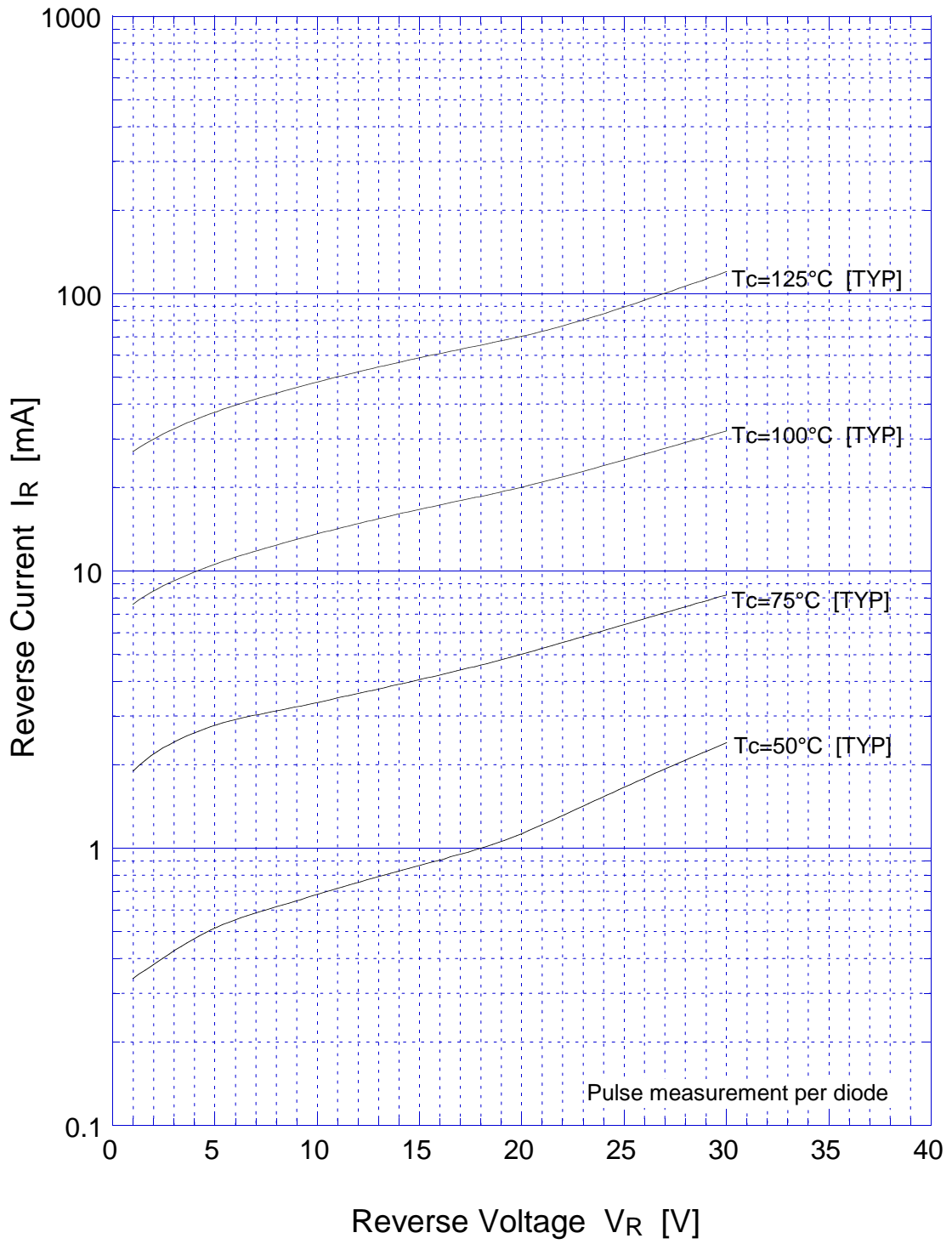

M1FH3

Reverse Power Dissipation

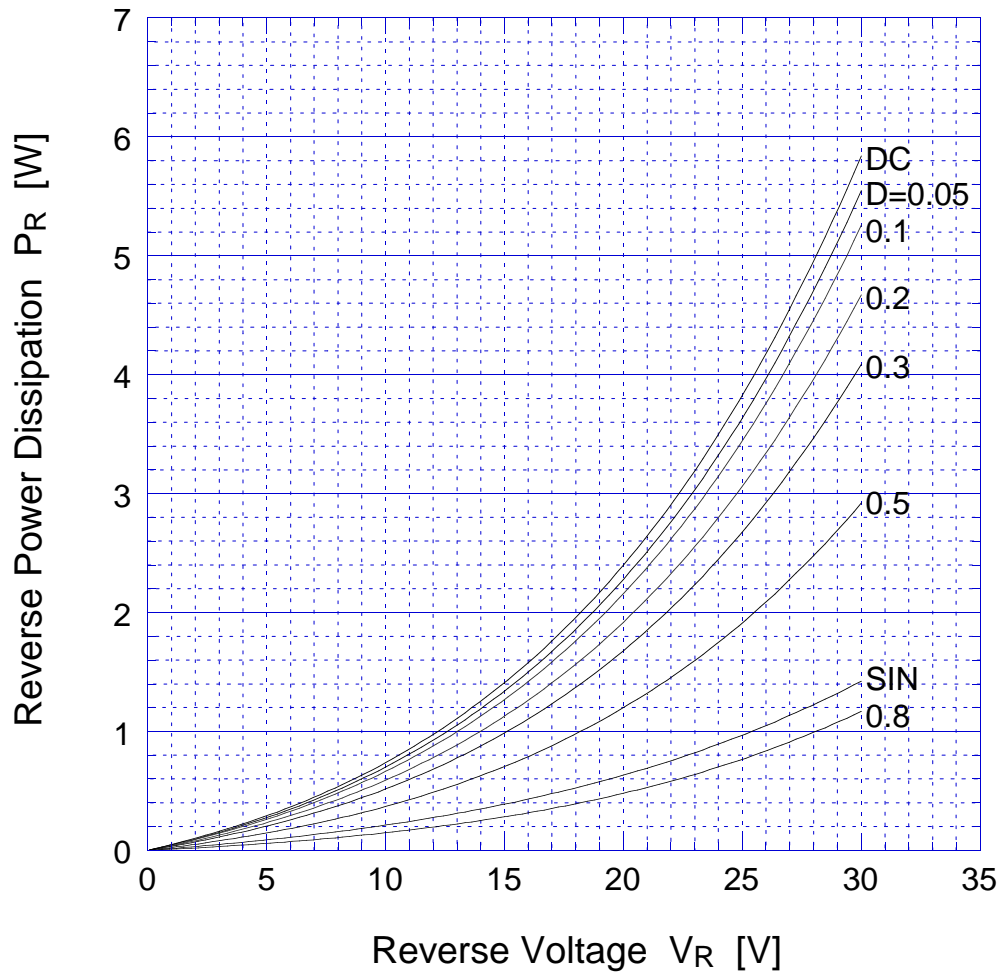

$T_j = 125^\circ\text{C}$

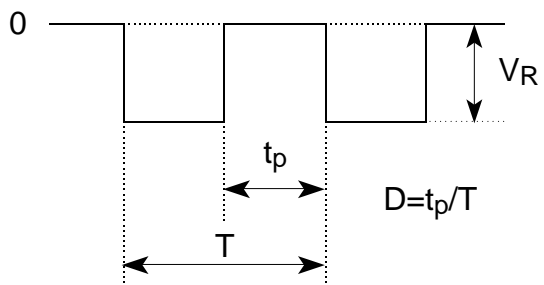

M1FH3 Junction Capacitance

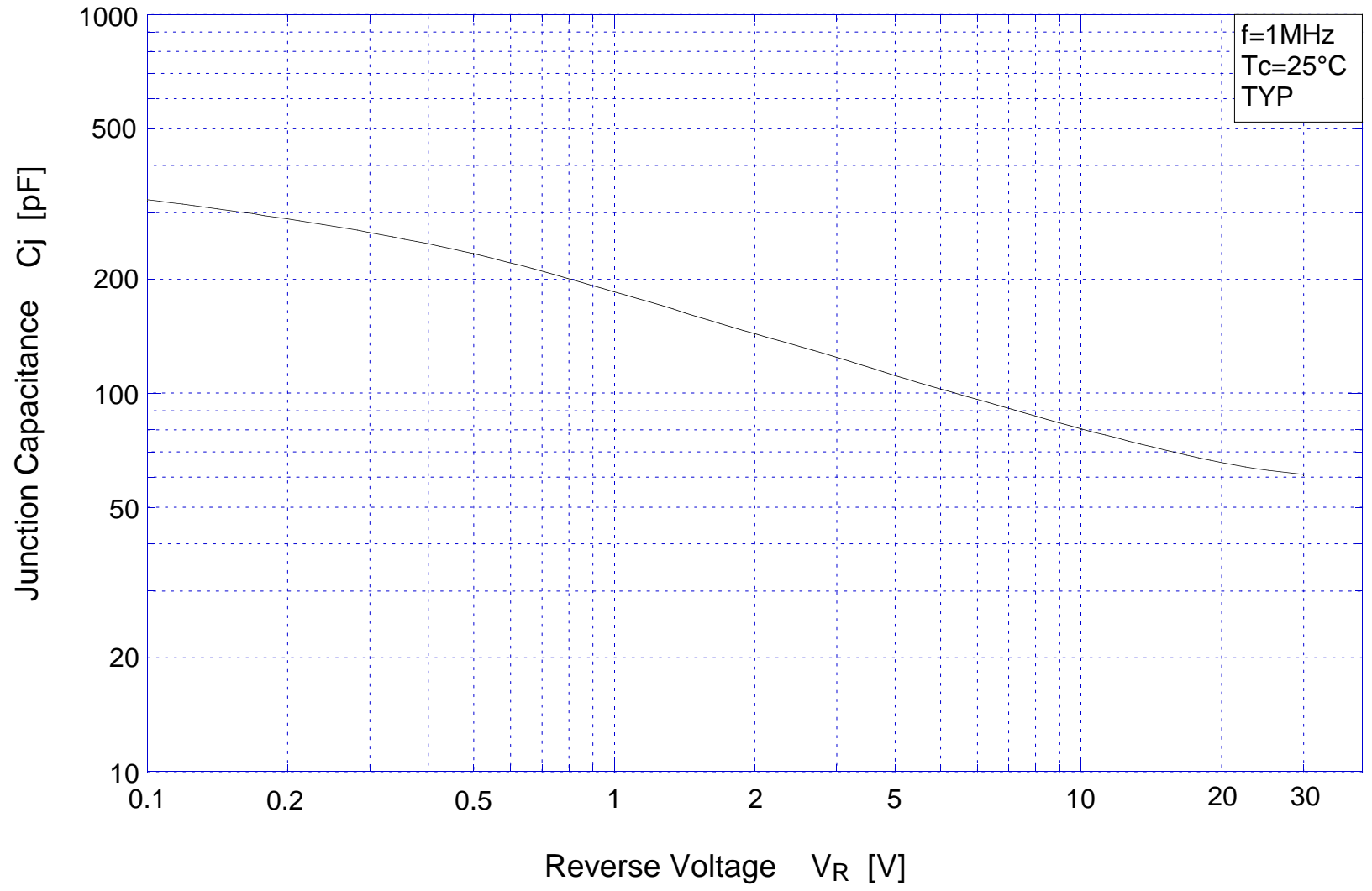

M1FH3

Derating Curve

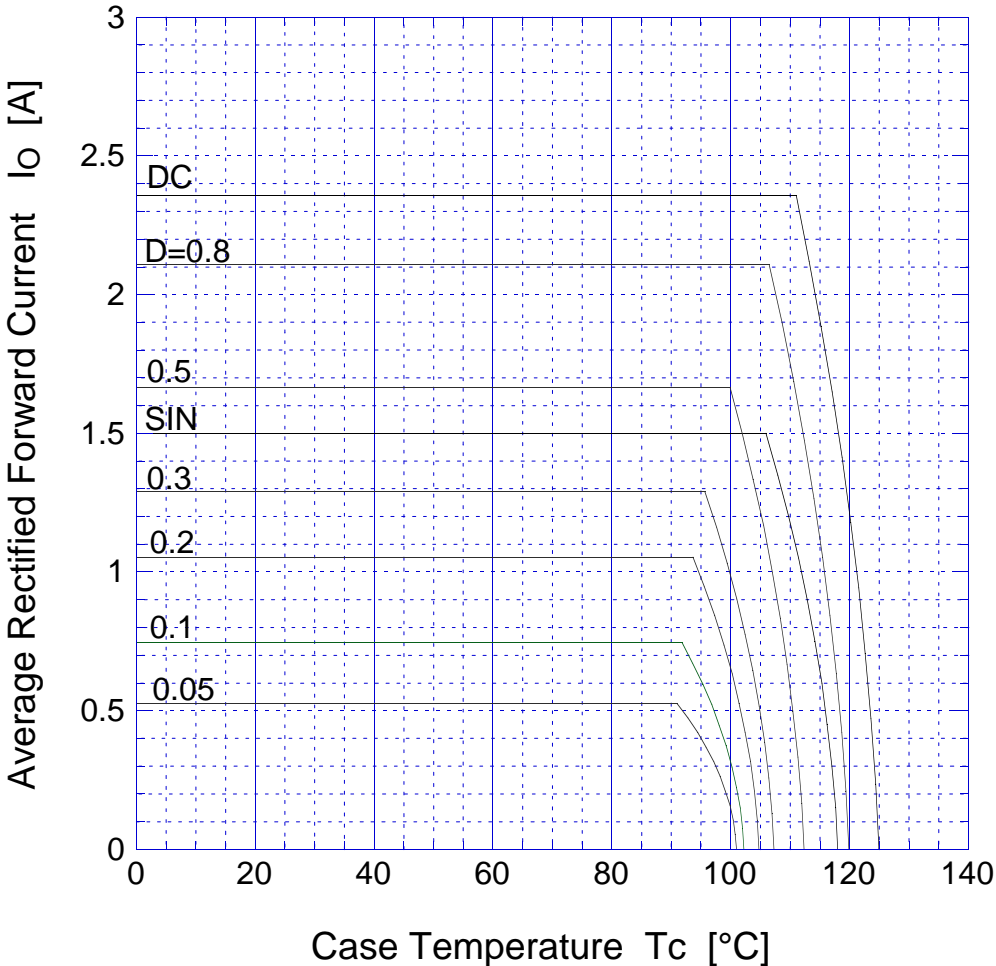

$V_R = 15V$

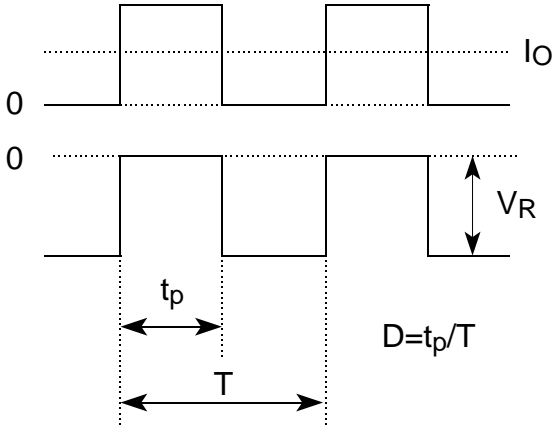

M1FH3

Derating Curve

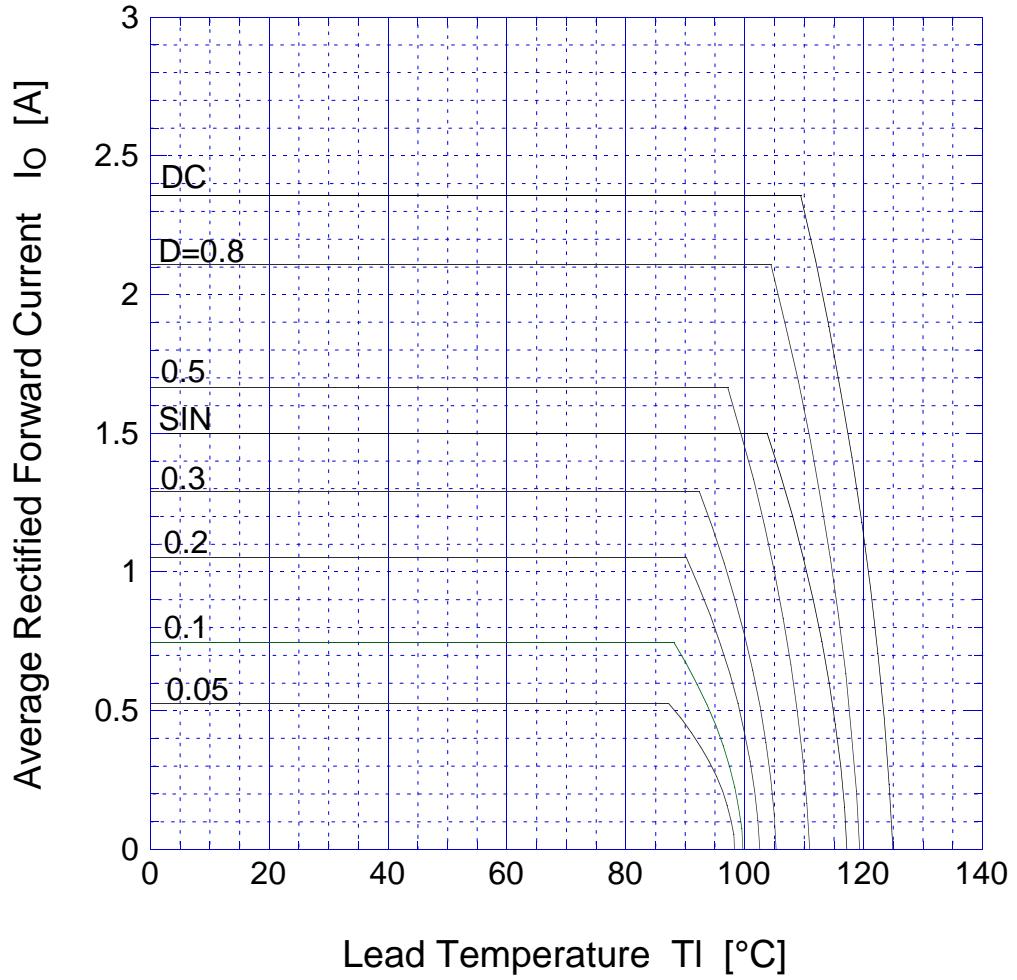

$V_R = 15V$

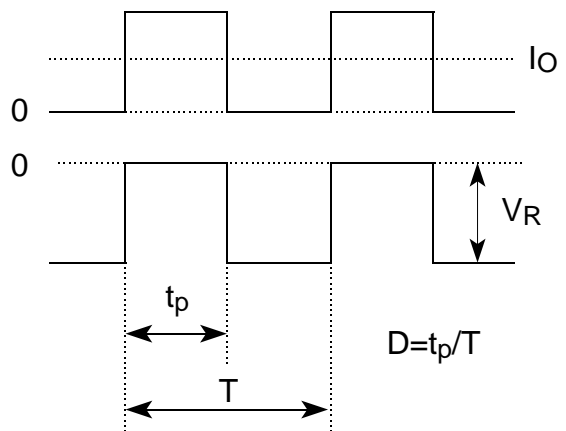

M1FH3 Transient Thermal Impedance

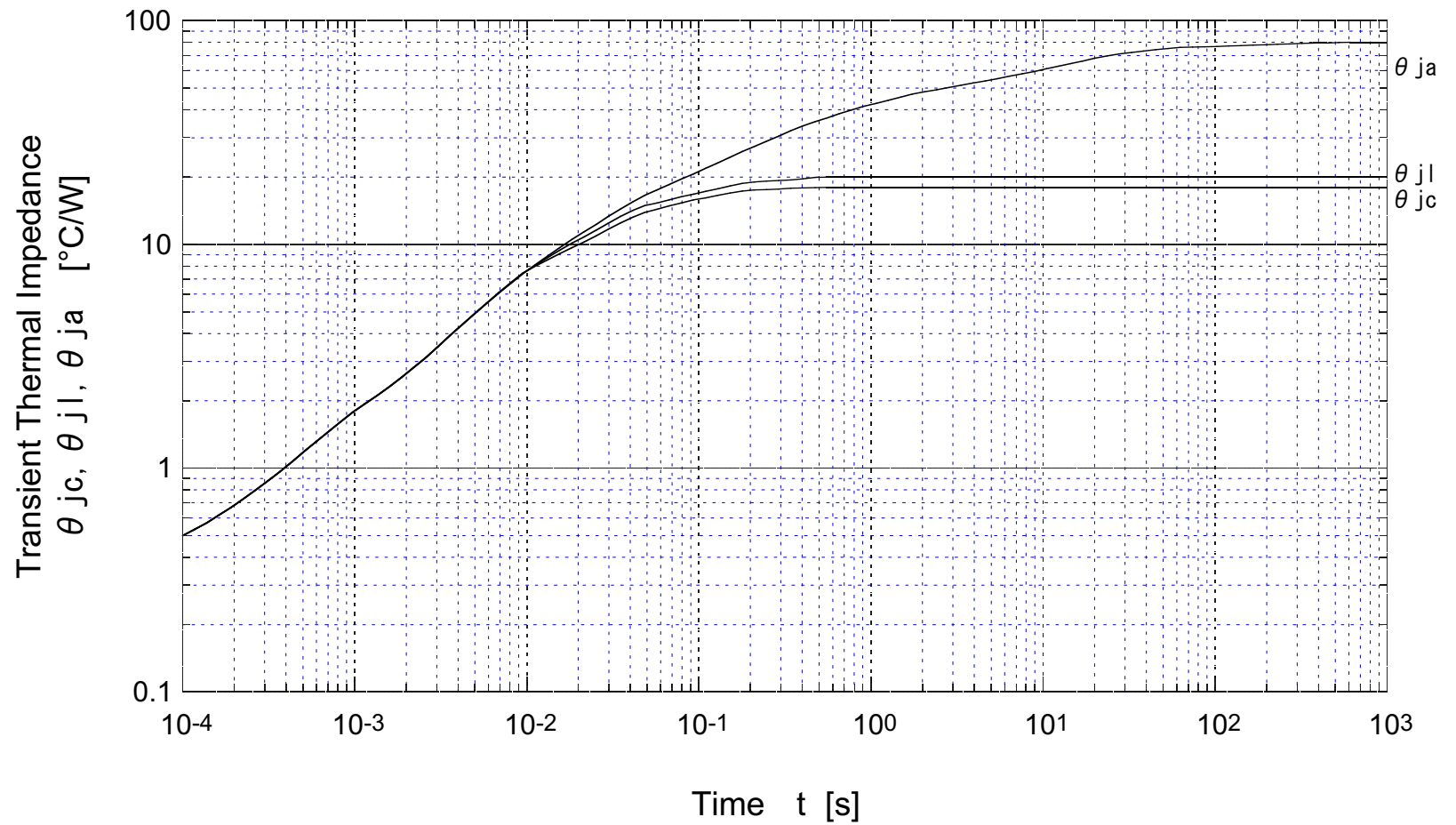

M1FH3 θ_{ja} - Conductor pattern area

