

# M51203TL, FP

## VOLTAGE COMPARATOR

### DESCRIPTION

The M51203 is a semiconductor integrated circuit for a voltage comparator that operates from a single power supply. Especially the M51203 has superiority as to characteristics of input current (high input resistance) and fits to wide ranged applications, for example CR timer, etc. M51203TL, FP's package is a mini SIP and FLAT package, therefore can use very easily.

### FEATURES

- Low input current (high input resistance) ..... 20nA (typ.)
- Operates at low supply voltage ..... 3.0~28V
- Capable of directly driving a relay or a lamp
- Low power dissipation ..... 2.5mA (max.)
- Including reference voltage for comparison
- Hysteresis characteristic between input and output
- High output breakdown voltage ..... 30V (max.)

### APPLICATION

Electric shutter, CR timer, voltage comparator, time delay circuit, oscillator (square wave)

### RECOMMENDED OPERATING CONDITIONS

- Supply voltage range ..... 3.0~28V
- Rated supply voltage ..... 12V

### PIN CONFIGURATION (TOP VIEW)

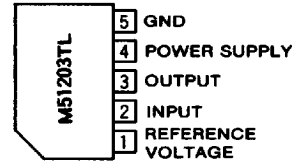

Outline 5P5T

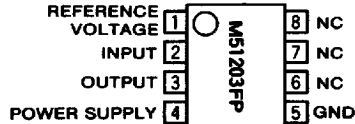

Outline 8P2S-A

NC : NO CONNECTION

### EQUIVALENT CIRCUIT

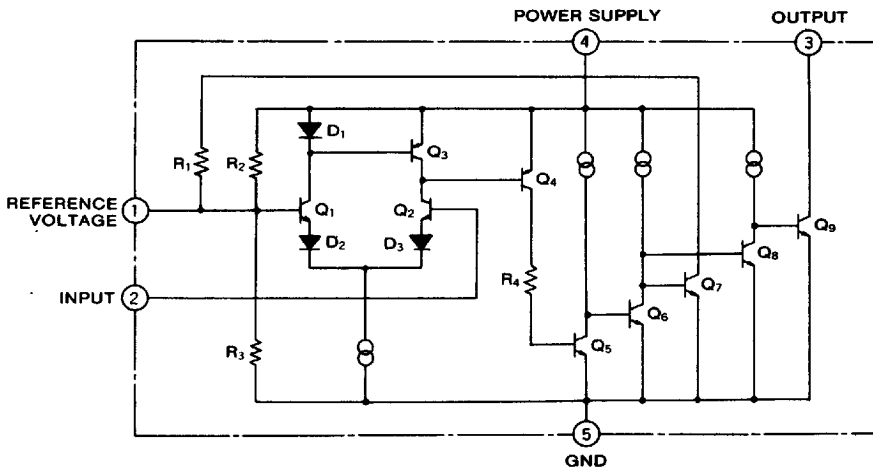

**VOLTAGE COMPARATOR**

**ABSOLUTE MAXIMUM RATINGS** ( $T_a=25^\circ\text{C}$ , unless otherwise noted)

Symbol	Parameter	Conditions	Ratings	Unit
$V_{CC}$	Supply voltage		28	V
$V_{IN}$	Input voltage		$V_{CC}$	V
$I_{OL}$	Output drive current	Output saturated	60	mA
$V_{OH}$	Output drive voltage		30	V
$P_d$	Power dissipation		180(M51203TL)	mW
			300(M51203FP)	
$K_\theta$	Thermal derating	$T_a \geq 25^\circ\text{C}$	1.8(M51203TL)	mW/ $^\circ\text{C}$
			3.0(M51203FP)	
$T_{opr}$	Operating temperature		$-20 \sim +75$	$^\circ\text{C}$
$T_{stg}$	Storage temperature		$-40 \sim +125$	$^\circ\text{C}$

**ELECTRICAL CHARACTERISTICS** ( $T_a=25^\circ\text{C}$ )

Symbol	Parameter	Test conditions	Limits			Unit		
			$V_{CC}$ (V)	Min	Typ		Max	
$V_{CC}$	Supply voltage range			3.0		28	V	
$I_{CC}$	Circuit current		6.0		1.9	2.5	mA	
			12.0		2.0			
			24.0		2.1			
$V_{IN}$	Input voltage		1.4		$V_{CC}-0.2$	V		
$I_{IN}$	Input current		6.0		20	75	nA	
			12.0					
			24.0					
$V_{REF}$	Reference voltage	$V_{IN}=0\text{V}$	6.0	2.7	3.0	3.3	V	
			12.0	5.4	6.0	6.6		
			24.0	10.8	12.0	13.2		
$\Delta V_{hys}$	Input/output hysteresis width voltage		6.0	1.0	1.2	1.4	V	
			12.0	1.9	2.4	2.9		
			24.0	3.8	4.8	5.8		
$V_{OL}$	Output saturation voltage	6.0			0.3	0.6	V	
		12.0						$R_L=100\Omega$
		24.0						$R_L=200\Omega$
$t_{PLH}$	Output "L-H" propagation delay time				1		$\mu\text{s}$	
$t_{PHL}$	Output "H-L" propagation delay time	12.0			10		$\mu\text{s}$	



**VOLTAGE COMPARATOR**

**TYPICAL CHARACTERISTICS** ( $T_a=25^\circ\text{C}$ ,  $V_{CC}=12\text{V}$ , unless otherwise noted)

**THERMAL DERATING (MAXIMUM RATING)**

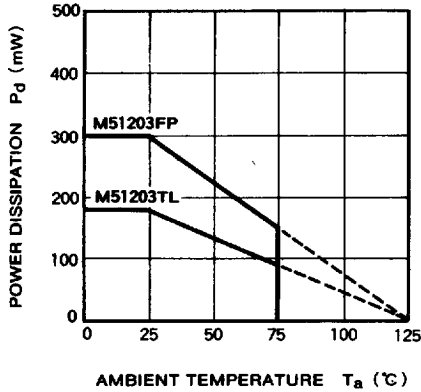

**OUTPUT VOLTAGE VS. INPUT VOLTAGE**

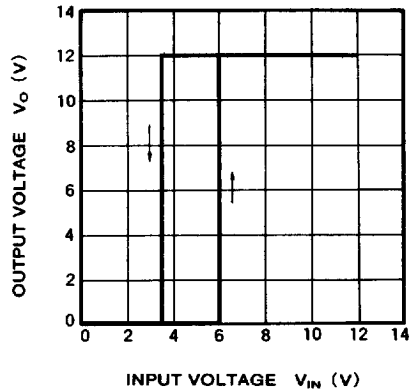

**INPUT CURRENT VS. INPUT VOLTAGE**

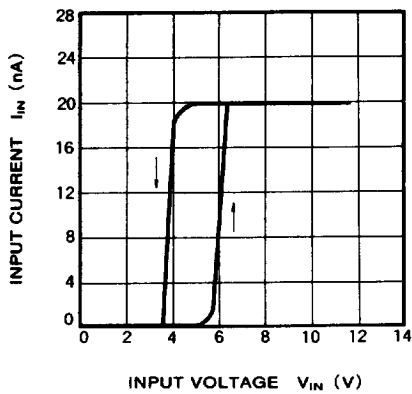

**INPUT CURRENT VS. SUPPLY VOLTAGE**

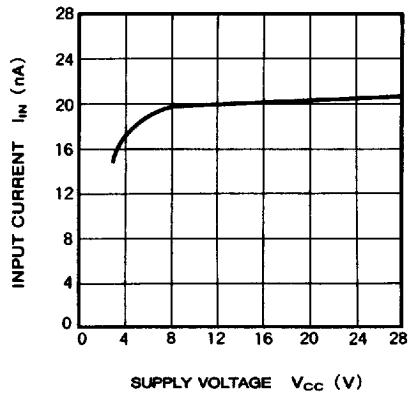

**CIRCUIT CURRENT VS. SUPPLY VOLTAGE**

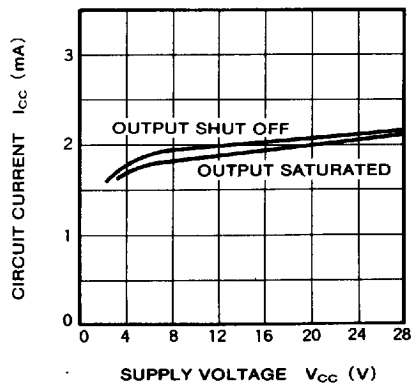

**INPUT CURRENT VS. AMBIENT TEMPERATURE**

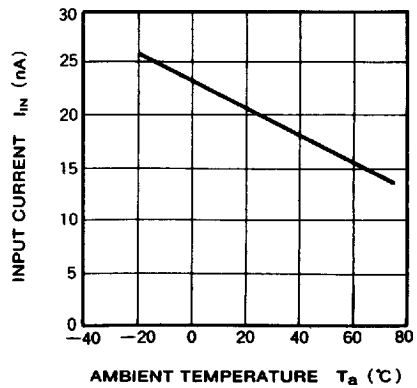

**CIRCUIT CURRENT VS. AMBIENT TEMPERATURE**

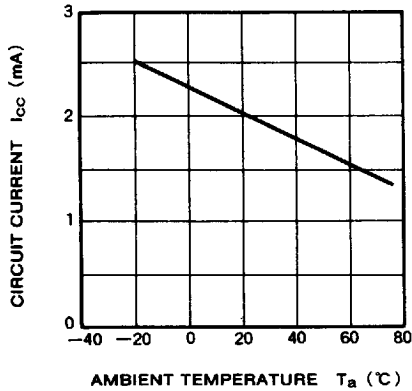

**APPLICATION EXAMPLES**

**(1) Voltage comparator**

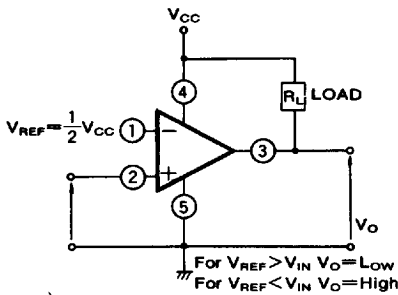

**(2) Oscillator**

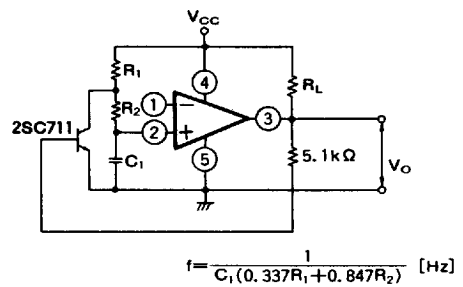

**(3) CR Timer**

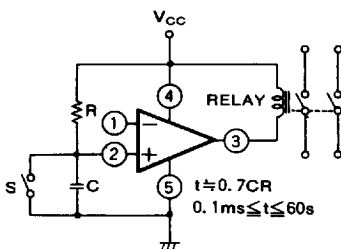

**PRECAUTIONS FOR USE**

1. Paying much attention is necessary for fear that the M51203TL,FP may flow large current and reach to destroy because of the structure when the terminals of  $V_{CC}$  and GND of the M51203TL,FP is connected wrong position each other.
2. Output is "open collector" and a loading resistor is not included. Connect a loading resistor to stabilize operation, in case of driving a next stage.