

M51204TL, FP

VOLTAGE COMPARATOR

DESCRIPTION

The M51204 is a semiconductor integrated circuit for a voltage comparator that operates from a single power supply. Especially the M51204 has superiority as to characteristics of input current (high input resistance) and fits to wide ranged applications, for example CR timer, etc. M51204TL, FP's package is a mini SIP and FLAT package, therefore can use very easily.

FEATURES

- Low input current 20nA(typ.)
- Wide operating voltage range 2.5~28V
- Low power dissipation 2.5mA(max.)
- Capable of directly driving a relay or a lamp
- High output breakdown voltage 30V(max.)

APPLICATION

Voltage comparator, electric shutter, CR timer, time delay circuit, oscillator (square wave)

RECOMMENDED OPERATING CONDITIONS

- Supply voltage range 2.5~28V
- Rated supply voltage 12V

PIN CONFIGURATION (TOP VIEW)

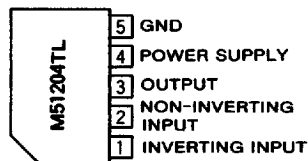

Outline 5P5T

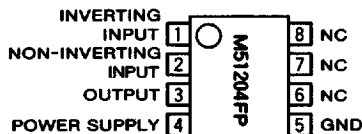

Outline 8P2S-A

NC : NO CONNECTION

EQUIVALENT CIRCUIT

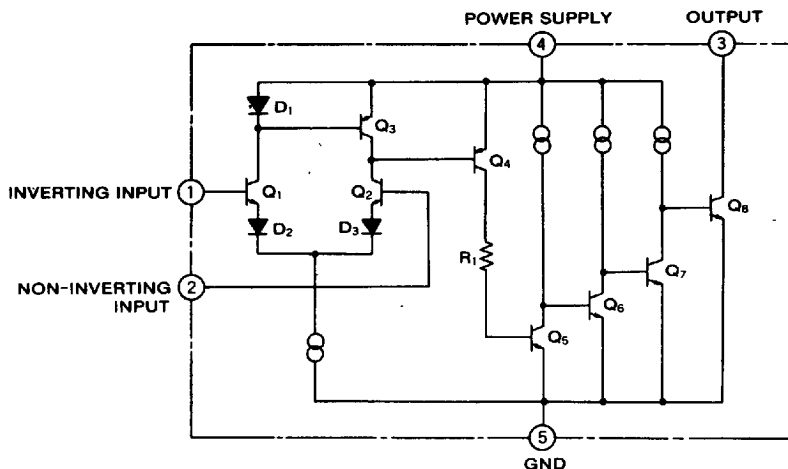

VOLTAGE COMPARATOR

ABSOLUTE MAXIMUM RATINGS ($T_a=25^\circ\text{C}$, unless otherwise noted)

Symbol	Parameter	Conditions	Ratings	Unit
V_{CC}	Supply voltage		28	V
V_{IN}	Input voltage		V_{CC}	V
I_{OL}	Output drive current	Output saturated	60	mA
V_{OH}	Output drive voltage		30	V
P_d	Power dissipation		180(M51204TL)	mW
			300(M51204FP)	
K_θ	Thermal derating	$T_a \geq 25^\circ\text{C}$	1.8(M51204TL)	mW/°C
			3.0(M51204FP)	
T_{opr}	Operating temperature		-20~+75	°C
T_{stg}	Storage temperature		-40~+125	°C

ELECTRICAL CHARACTERISTICS ($T_a=25^\circ\text{C}$)

Symbol	Parameter	Test conditions		Limits			Unit
		V_{CC} (V)		Min	Typ	Max	
V_{CC}	Supply voltage range			2.5		28	V
I_{CC}	Circuit current	6.0			1.8	2.5	mA
		12.0					
		24.0					
$V_{IN①}$	Inverting input voltage	12.0		1.4		$V_{CC}-0.2$	V
$V_{IN②}$	Non-inverting input voltage	12.0					
$I_{IN①}$	Inverting input current	6.0			20	75	nA
		12.0					
		24.0					
$I_{IN②}$	Non-inverting input current	6.0			20	75	nA
		12.0					
		24.0					
V_{IO}	Input offset voltage	6.0	Reference voltage at Pin ①	-7	2	12	mV
		12.0					
		24.0					
V_{OL}	Output saturation voltage	6.0	$R_L=100\Omega$		0.3	0.6	V
		12.0	$R_L=200\Omega$				
		24.0	$R_L=400\Omega$				
t_{PLH}	Output "L-H" propagation delay time	12.0			1		μs
t_{PHL}	Output "H-L" propagation delay time				10		μs

VOLTAGE COMPARATOR

TYPICAL CHARACTERISTICS ($T_a=25^\circ\text{C}$, unless otherwise noted)

THERMAL DERATING (MAXIMUM RATING)

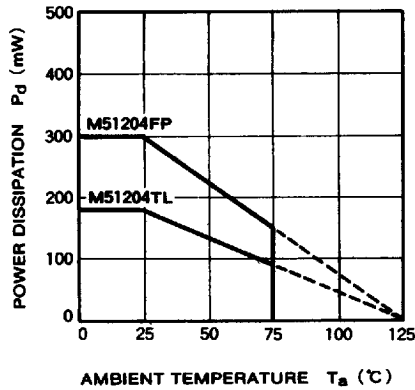

OUTPUT VOLTAGE VS. INPUT VOLTAGE

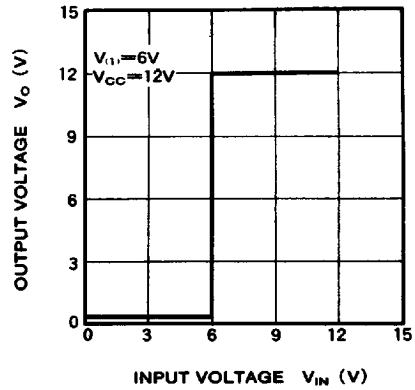

INPUT CURRENT VS. INPUT VOLTAGE

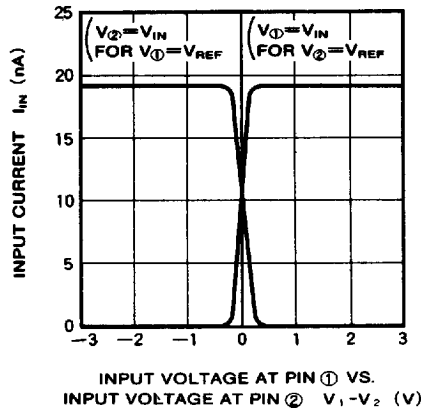

INPUT CURRENT VS. SUPPLY VOLTAGE

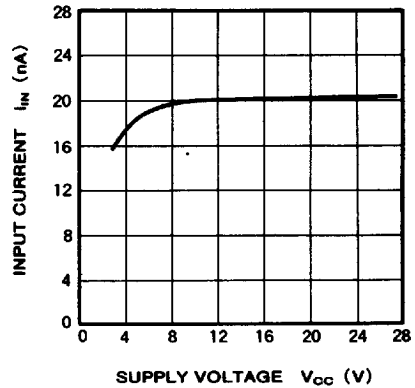

CIRCUIT CURRENT VS. SUPPLY VOLTAGE

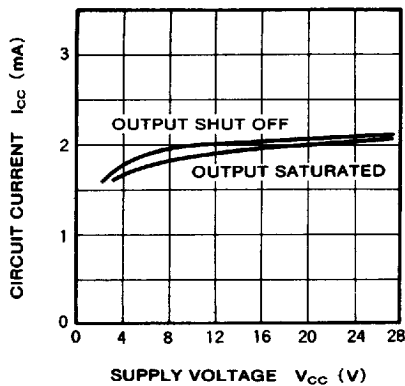

INPUT CURRENT VS. AMBIENT TEMPERATURE

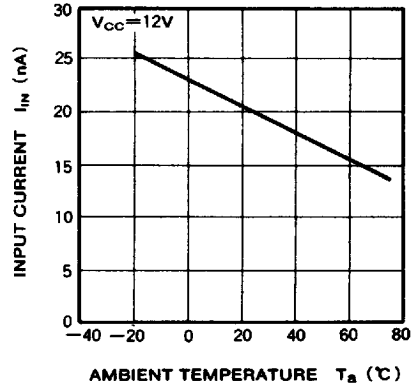

APPLICATION EXAMPLES

CIRCUIT CURRENT VS. AMBIENT TEMPERATURE

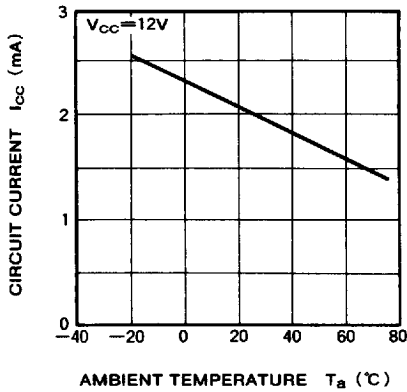

(1) Voltage comparator

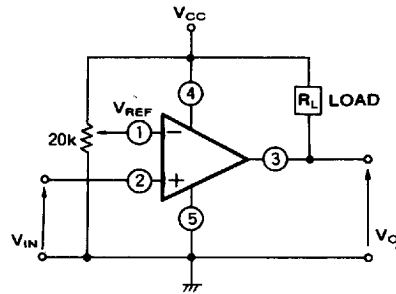

(2) Sensor detection circuit

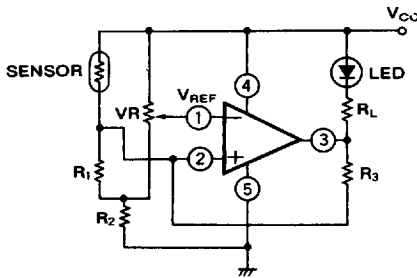

(3) Battery check circuit

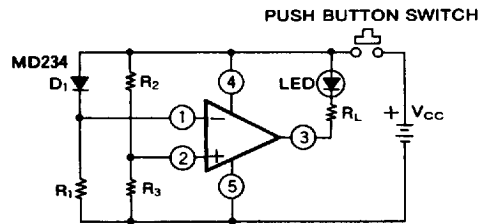

(4) Oscillator

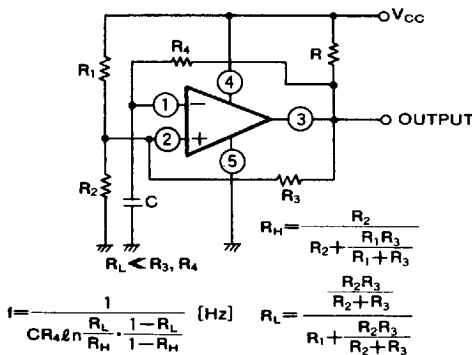

PRECAUTIONS FOR USE

1. Paying much attention is necessary for fear that the M51204TL,FP may flow large current and reach to destroy because of the structure when the terminals of V_{CC} and GND of the M51204TL,FP is connected wrong position each other.
2. Output is "open collector" and a loading resistor is not included. Connect a loading resistor to stabilize operation, in case of driving a next stage.