

MC79L00, A Series

Three-Terminal Low Current Negative Voltage Regulators

The MC79L00, A Series negative voltage regulators are inexpensive, easy-to-use devices suitable for numerous applications requiring up to 100 mA. Like the higher powered MC7900 Series negative regulators, this series features thermal shutdown and current limiting, making them remarkably rugged. In most applications, no external components are required for operation.

The MC79L00 devices are useful for on-card regulation or any other application where a regulated negative voltage at a modest current level is needed. These regulators offer substantial advantage over the common resistor/zener diode approach.

- No External Components Required
- Internal Short Circuit Current Limiting
- Internal Thermal Overload Protection
- Low Cost
- Complementary Positive Regulators Offered (MC78L00 Series)
- Available in Either $\pm 5\%$ (AC) or $\pm 10\%$ (C) Selections

THREE-TERMINAL LOW CURRENT NEGATIVE FIXED VOLTAGE REGULATORS

SEMICONDUCTOR TECHNICAL DATA

P SUFFIX PLASTIC PACKAGE CASE 29

- Pin 1. Ground
2. Input
3. Output

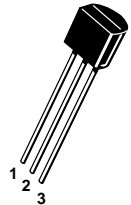

D SUFFIX PLASTIC PACKAGE CASE 751 (SOP-8)*

- Pin 1. V_{out} 5. GND
2. V_{in} 6. V_{in}
3. V_{in} 7. V_{in}
4. NC 8. NC

* SOP-8 is an internally modified SO-8 package. Pins 2, 3, 6, and 7 are electrically common to the die attach flag. This internal lead frame modification decreases package thermal resistance and increases power dissipation capability when appropriately mounted on a printed circuit board. SOP-8 conforms to all external dimensions of the standard SO-8 package.

Representative Schematic Diagram

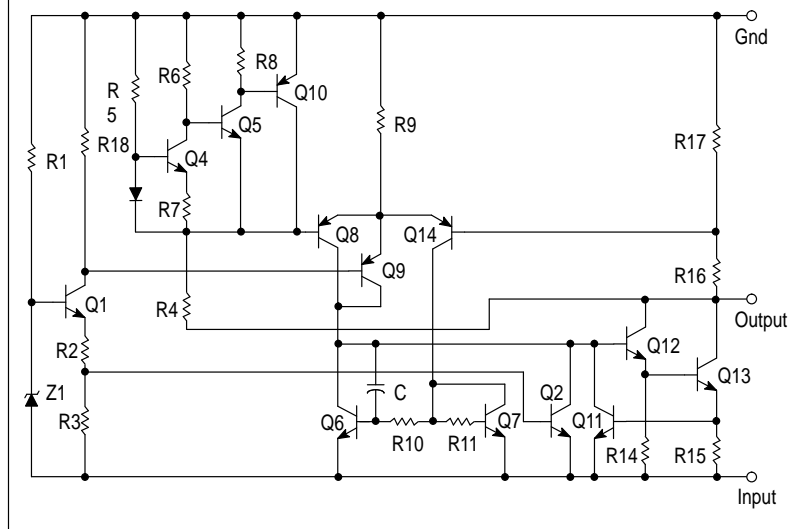

* Automotive temperature range selections are available with special test conditions and additional tests in 5, 12 and 15 V devices. Contact your local Motorola sales office for information.

Device No. $\pm 10\%$	Device No. 5%	Nominal Voltage
MC79L05C	MC79L05AC	-5.0
MC79L12C	MC79L12AC	-12
MC79L15C	MC79L15AC	-15
MC79L18C	MC79L18AC	-18
MC79L24C	MC79L24AC	-24

ORDERING INFORMATION

Device	Operating Temperature Range	Package
MC79LXXACD*	$T_J = 0^\circ \text{ to } +125^\circ \text{C}$	SOP-8
MC79LXXACP		Plastic Power
MC79LXXCP		Plastic Power
MC79LXXABD*	$T_J = -40^\circ \text{ to } +125^\circ \text{C}$	SOP-8
MC79LXXABP*		Plastic Power

XX indicates nominal voltage

MC79L00, A Series

MAXIMUM RATINGS ($T_A = +25^\circ\text{C}$, unless otherwise noted.)

Rating	Symbol	Value	Unit
Input Voltage (-5 V) (-12, -15, -18 V) (-24 V)	V_I	-30 -35 -40	Vdc
Storage Temperature Range	T_{stg}	-65 to +150	$^\circ\text{C}$
Junction Temperature	T_J	+150	$^\circ\text{C}$

ELECTRICAL CHARACTERISTICS ($V_I = -10\text{ V}$, $I_O = 40\text{ mA}$, $C_I = 0.33\text{ }\mu\text{F}$, $C_O = 0.1\text{ }\mu\text{F}$, $-40^\circ\text{C} < T_J < +125^\circ\text{C}$ (for MC79LXXAB), $0^\circ\text{C} < T_J < +125^\circ\text{C}$ (for MC79LXXAC)).

Characteristics	Symbol	MC79L05C, AB			MC79L05AC, AB			Unit
		Min	Typ	Max	Min	Typ	Max	
Output Voltage ($T_J = +25^\circ\text{C}$)	V_O	-4.6	-5.0	-5.4	-4.8	-5.0	-5.2	Vdc
Input Regulation ($T_J = +25^\circ\text{C}$) -7.0 Vdc $\geq V_I \geq -20\text{ Vdc}$ -8.0 Vdc $\geq V_I \geq -20\text{ Vdc}$	Reg _{line}	-	-	200 150	-	-	150 100	mV
Load Regulation $T_J = +25^\circ\text{C}$, $1.0\text{ mA} \leq I_O \leq 100\text{ mA}$ $1.0\text{ mA} \leq I_O \leq 40\text{ mA}$	Reg _{load}	-	-	60 30	-	-	60 30	mV
Output Voltage -7.0 Vdc $\geq V_I \geq -20\text{ Vdc}$, $1.0\text{ mA} \leq I_O \leq 40\text{ mA}$ $V_I = -10\text{ Vdc}$, $1.0\text{ mA} \leq I_O \leq 70\text{ mA}$	V_O	-4.5 -4.5	-	-5.5 -5.5	-4.75 -4.75	-	-5.25 -5.25	Vdc
Input Bias Current ($T_J = +25^\circ\text{C}$) ($T_J = +125^\circ\text{C}$)	I_{IB}	-	-	6.0 5.5	-	-	6.0 5.5	mA
Input Bias Current Change -8.0 Vdc $\geq V_I \geq -20\text{ Vdc}$ $1.0\text{ mA} \leq I_O \leq 40\text{ mA}$	I_{IB}	-	-	1.5 0.2	-	-	1.5 0.1	mA
Output Noise Voltage ($T_A = +25^\circ\text{C}$, $10\text{ Hz} \leq f \leq 100\text{ kHz}$)	V_n	-	40	-	-	40	-	μV
Ripple Rejection ($-8.0 \geq V_I \geq -18\text{ Vdc}$, $f = 120\text{ Hz}$, $T_J = +25^\circ\text{C}$)	RR	40	49	-	41	49	-	dB
Dropout Voltage ($I_O = 40\text{ mA}$, $T_J = +25^\circ\text{C}$)	$ V_I - V_O $	-	1.7	-	-	1.7	-	Vdc

ELECTRICAL CHARACTERISTICS ($V_I = -19\text{ V}$, $I_O = 40\text{ mA}$, $C_I = 0.33\text{ }\mu\text{F}$, $C_O = 0.1\text{ }\mu\text{F}$, $-40^\circ\text{C} < T_J < +125^\circ\text{C}$ (for MC79LXXAC), $0^\circ\text{C} < T_J < +125^\circ\text{C}$ (for MC79LXXAB)).

Characteristics	Symbol	MC79L12C, AB			MC79L12AC, AB			Unit
		Min	Typ	Max	Min	Typ	Max	
Output Voltage ($T_J = +25^\circ\text{C}$)	V_O	-11.1	-12	-12.9	-11.5	-12	-12.5	Vdc
Input Regulation ($T_J = +25^\circ\text{C}$) -14.5 Vdc $\geq V_I \geq -27\text{ Vdc}$ -16 Vdc $\geq V_I \geq -27\text{ Vdc}$	Reg _{line}	-	-	250 200	-	-	250 200	mV
Load Regulation $T_J = +25^\circ\text{C}$, $1.0\text{ mA} \leq I_O \leq 100\text{ mA}$ $1.0\text{ mA} \leq I_O \leq 40\text{ mA}$	Reg _{load}	-	-	100 50	-	-	100 50	mV
Output Voltage -14.5 Vdc $\geq V_I \geq -27\text{ Vdc}$, $1.0\text{ mA} \leq I_O \leq 40\text{ mA}$ $V_I = -19\text{ Vdc}$, $1.0\text{ mA} \leq I_O \leq 70\text{ mA}$	V_O	-10.8 -10.8	-	-13.2 -13.2	-11.4 -11.4	-	-12.6 -12.6	Vdc
Input Bias Current ($T_J = +25^\circ\text{C}$) ($T_J = +125^\circ\text{C}$)	I_{IB}	-	-	6.5 6.0	-	-	6.5 6.0	mA
Input Bias Current Change -16 Vdc $\geq V_I \geq -27\text{ Vdc}$ $1.0\text{ mA} \leq I_O \leq 40\text{ mA}$	I_{IB}	-	-	1.5 0.2	-	-	1.5 0.2	mA
Output Noise Voltage ($T_A = +25^\circ\text{C}$, $10\text{ Hz} \leq f \leq 100\text{ kHz}$)	V_n	-	80	-	-	80	-	μV
Ripple Rejection ($-15 \leq V_I \leq -25\text{ Vdc}$, $f = 120\text{ Hz}$, $T_J = +25^\circ\text{C}$)	RR	36	42	-	37	42	-	dB
Dropout Voltage ($I_O = 40\text{ mA}$, $T_J = +25^\circ\text{C}$)	$ V_I - V_O $	-	1.7	-	-	1.7	-	Vdc

MC79L00, A Series

ELECTRICAL CHARACTERISTICS ($V_I = -23\text{ V}$, $I_O = 40\text{ mA}$, $C_I = 0.33\text{ }\mu\text{F}$, $C_O = 0.1\text{ }\mu\text{F}$, $-40^\circ\text{C} < T_J < +125^\circ\text{C}$ (for MC79LXXAB), $0^\circ\text{C} < T_J < +125^\circ\text{C}$ (for MC79LXXAC)).

Characteristics	Symbol	MC79L15C			MC79L15AC, AB			Unit
		Min	Typ	Max	Min	Typ	Max	
Output Voltage ($T_J = +25^\circ\text{C}$)	V_O	-13.8	-15	-16.2	-14.4	-15	-15.6	Vdc
Input Regulation ($T_J = +25^\circ\text{C}$) $-17.5\text{ Vdc} \geq V_I \geq -30\text{ Vdc}$ $-20\text{ Vdc} \geq V_I \geq -30\text{ Vdc}$	Reg _{line}	-	-	300 250	-	-	300 250	mV
Load Regulation $T_J = +25^\circ\text{C}$, $1.0\text{ mA} \leq I_O \leq 100\text{ mA}$ $1.0\text{ mA} \leq I_O \leq 40\text{ mA}$	Reg _{load}	-	-	150 75	-	-	150 75	mV
Output Voltage $-17.5\text{ Vdc} \geq V_I \geq -\text{Vdc}$, $1.0\text{ mA} \leq I_O \leq 40\text{ mA}$ $V_I = -23\text{ Vdc}$, $1.0\text{ mA} \leq I_O \leq 70\text{ mA}$	V_O	-13.5 -13.5	-	-16.5 -16.5	-14.25 -14.25	-	-15.75 -15.75	Vdc
Input Bias Current ($T_J = +25^\circ\text{C}$) ($T_J = +125^\circ\text{C}$)	I_{IB}	-	-	6.5 6.0	-	-	6.5 6.0	mA
Input Bias Current Change $-20\text{ Vdc} \geq V_I \geq -30\text{ Vdc}$ $1.0\text{ mA} \leq I_O \leq 40\text{ mA}$	ΔI_{IB}	-	-	1.5 0.2	-	-	1.5 0.1	mA
Output Noise Voltage ($T_A = +25^\circ\text{C}$, $10\text{ Hz} \leq f \leq 100\text{ kHz}$)	V_N	-	90	-	-	90	-	μV
Ripple Rejection ($-18.5 \leq V_I \leq -28.5\text{ Vdc}$, $f = 120\text{ Hz}$)	RR	33	39	-	34	39	-	dB
Dropout Voltage $I_O = 40\text{ mA}$, $T_J = +25^\circ\text{C}$	$ V_I - V_O $	-	1.7	-	-	1.7	-	Vdc

ELECTRICAL CHARACTERISTICS ($V_I = -27\text{ V}$, $I_O = 40\text{ mA}$, $C_I = 0.33\text{ }\mu\text{F}$, $C_O = 0.1\text{ }\mu\text{F}$, $0^\circ\text{C} < T_J < +125^\circ\text{C}$, unless otherwise noted).

Characteristics	Symbol	MC79L18C			MC79L18AC			Unit
		Min	Typ	Max	Min	Typ	Max	
Output Voltage ($T_J = +25^\circ\text{C}$)	V_O	-16.6	-18	-19.4	-17.3	-18	-18.7	Vdc
Input Regulation ($T_J = +25^\circ\text{C}$) $-20.7\text{ Vdc} \geq V_I \geq -33\text{ Vdc}$ $-21.4\text{ Vdc} \geq V_I \geq -33\text{ Vdc}$ $-22\text{ Vdc} \geq V_I \geq -33\text{ Vdc}$ $-21\text{ Vdc} \geq V_I \geq -33\text{ Vdc}$	Reg _{line}	-	-	-	-	-	325 - - 275	mV
Load Regulation $T_J = +25^\circ\text{C}$, $1.0\text{ mA} \leq I_O \leq 100\text{ mA}$ $1.0\text{ mA} \leq I_O \leq 40\text{ mA}$	Reg _{load}	-	-	170 85	-	-	170 85	mV
Output Voltage $-20.7\text{ Vdc} \geq V_I \geq -33\text{ Vdc}$, $1.0\text{ mA} \leq I_O \leq 40\text{ mA}$ $-21.4\text{ Vdc} \geq V_I \geq -33\text{ Vdc}$, $1.0\text{ mA} \leq I_O \leq 40\text{ mA}$ $V_I = -27\text{ Vdc}$, $1.0\text{ mA} \leq I_O \leq 70\text{ mA}$	V_O	-	-	-	-17.1	-	-18.9 - -18.9	Vdc
Input Bias Current ($T_J = +25^\circ\text{C}$) ($T_J = +125^\circ\text{C}$)	I_{IB}	-	-	6.5 6.0	-	-	6.5 6.0	mA
Input Bias Current Change $-21\text{ Vdc} \geq V_I \geq -33\text{ Vdc}$ $-27\text{ Vdc} \geq V_I \geq -33\text{ Vdc}$ $1.0\text{ mA} \leq I_O \leq 40\text{ mA}$	I_{IB}	-	-	-	-	-	1.5 - 0.1	mA
Output Noise Voltage ($T_A = +25^\circ\text{C}$, $10\text{ Hz} \leq f \leq 100\text{ kHz}$)	V_n	-	150	-	-	150	-	μV
Ripple Rejection ($-23 \leq V_I \leq -33\text{ Vdc}$, $f = 120\text{ Hz}$, $T_J = +25^\circ\text{C}$)	RR	32	46	-	33	48	-	dB
Dropout Voltage $I_O = 40\text{ mA}$, $T_J = +25^\circ\text{C}$	$ V_I - V_O $	-	1.7	-	-	1.7	-	Vdc

MC79L00, A Series

ELECTRICAL CHARACTERISTICS ($V_I = -33\text{ V}$, $I_O = 40\text{ mA}$, $C_I = 0.33\text{ }\mu\text{F}$, $C_O = 0.1\text{ }\mu\text{F}$, $0^\circ\text{C} < T_J < +125^\circ\text{C}$, unless otherwise noted).

Characteristics	Symbol	MC79L24C			MC79L24AC			Unit
		Min	Typ	Max	Min	Typ	Max	
Output Voltage ($T_J = +25^\circ\text{C}$)	V_O	-22.1	-24	-25.9	-23	-24	-25	Vdc
Input Regulation ($T_J = +25^\circ\text{C}$) $-27\text{ Vdc} \geq V_I \geq -38\text{ Vdc}$ $-27.5\text{ Vdc} \geq V_I \geq -38\text{ Vdc}$ $-28\text{ Vdc} \geq V_I \geq -38\text{ Vdc}$	Reg _{line}							mV
		-	-	-	-	-	350	
		-	-	350	-	-	-	
		-	-	300	-	-	300	
Load Regulation $T_J = +25^\circ\text{C}$, $1.0\text{ mA} \leq I_O \leq 100\text{ mA}$ $1.0\text{ mA} \leq I_O \leq 40\text{ mA}$	Reg _{load}							mV
		-	-	200	-	-	200	
		-	-	100	-	-	100	
Output Voltage $-27\text{ Vdc} \geq V_I \geq -38\text{ V}$, $1.0\text{ mA} \leq I_O \leq 40\text{ mA}$ $-28\text{ Vdc} \geq V_I \geq -38\text{ Vdc}$, $1.0\text{ mA} \leq I_O \leq 40\text{ mA}$ $V_I = -33\text{ Vdc}$, $1.0\text{ mA} \leq I_O \leq 70\text{ mA}$	V_O							Vdc
		-	-	-	-22.8	-	-25.2	
		-21.4	-	-26.4	-	-	-	
		-21.4	-	-26.4	-22.8	-	-25.2	
Input Bias Current ($T_J = +25^\circ\text{C}$) ($T_J = +125^\circ\text{C}$)	I_{IB}							mA
		-	-	6.5	-	-	6.5	
		-	-	6.0	-	-	6.0	
Input Bias Current Change $-28\text{ Vdc} \geq V_I \geq -38\text{ Vdc}$ $1.0\text{ mA} \leq I_O \leq 40\text{ mA}$	ΔI_{IB}							mA
		-	-	1.5	-	-	1.5	
		-	-	0.2	-	-	0.1	
Output Noise Voltage ($T_A = +25^\circ\text{C}$, $10\text{ Hz} \leq f \leq 100\text{ kHz}$)	V_n							μV
		-	200	-	-	200	-	
Ripple Rejection ($-29 \leq V_I \leq -35\text{ Vdc}$, $f = 120\text{ Hz}$, $T_J = +25^\circ\text{C}$)	RR							dB
		30	43	-	31	47	-	
Dropout Voltage $I_O = 40\text{ mA}$, $T_J = +25^\circ\text{C}$	$ V_I - V_O $							Vdc
		-	1.7	-	-	1.7	-	

APPLICATIONS INFORMATION

Design Considerations

The MC79L00, A Series of fixed voltage regulators are designed with Thermal Overload Protections that shuts down the circuit when subjected to an excessive power overload condition, Internal Short Circuit Protection that limits the maximum current the circuit will pass.

In many low current applications, compensation capacitors are not required. However, it is recommended that the regulator input be bypassed with a capacitor if the regulator is connected to the power supply filter with long wire length, or if the output load capacitance is large. An input

bypass capacitor should be selected to provide good high-frequency characteristics to insure stable operation under all load conditions. A $0.33\text{ }\mu\text{F}$ or larger tantalum, mylar, or other capacitor having low internal impedance at high frequencies should be chosen. The bypass capacitor should be mounted with the shortest possible leads directly across the regulator's input terminals. Normally good construction techniques should be used to minimize ground loops and lead resistance drops since the regulator has no external sense lead. Bypassing the output is also recommended.

Figure 1. Positive and Negative Regulator

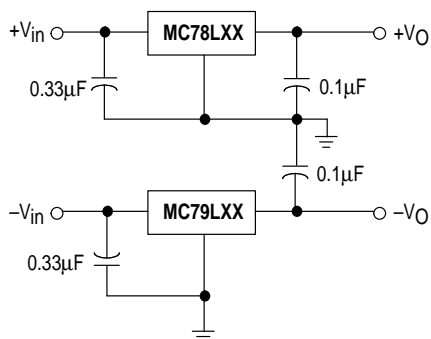
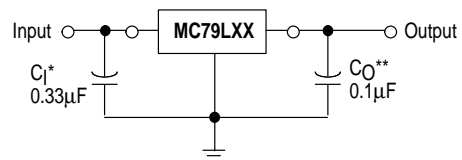

Figure 2. Standard Application



A common ground is required between the input and the output voltages. The input voltage must remain typically 2.0 V above the output voltage even during the low point on the ripple voltage.

* C_I is required if regulator is located an appreciable distance from the power supply filter

** C_O improves stability and transient response.

MC79L00, A Series

TYPICAL CHARACTERISTICS

($T_A = +25^\circ\text{C}$, unless otherwise noted.)

Figure 3. Dropout Characteristics

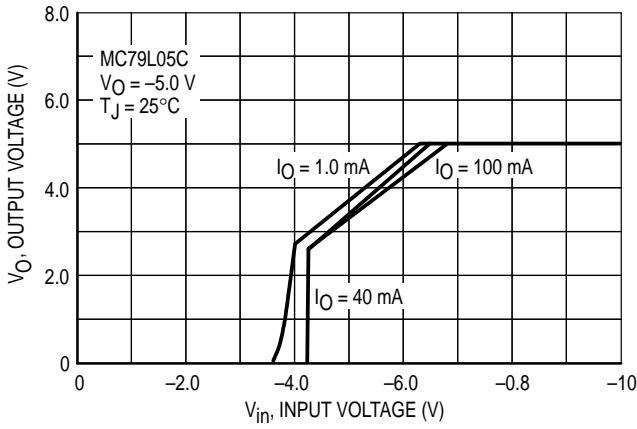

Figure 4. Dropout Voltage versus Junction Temperature

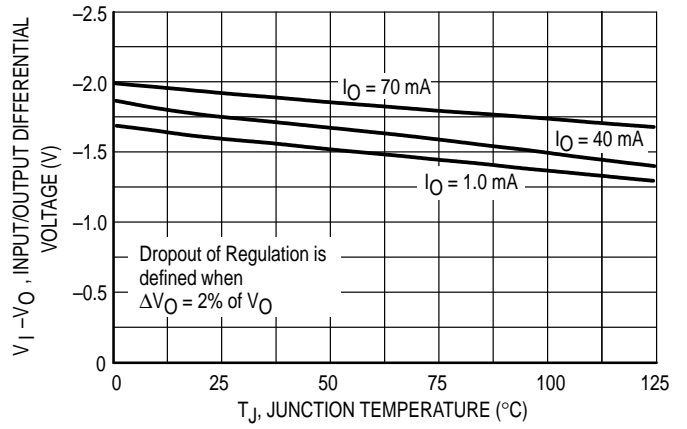

Figure 5. Input Bias Current versus Ambient Temperature

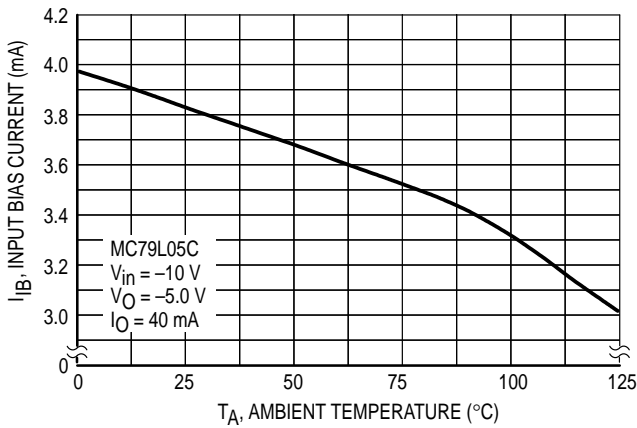

Figure 6. Input Bias Current versus Input Voltage

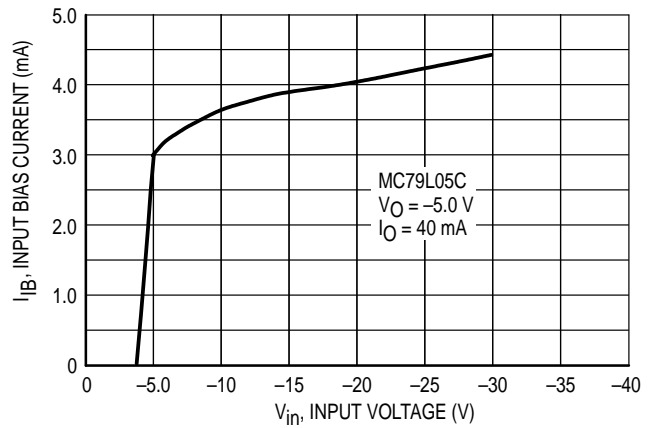

Figure 7. Maximum Average Power Dissipation versus Ambient Temperature (TO-92)

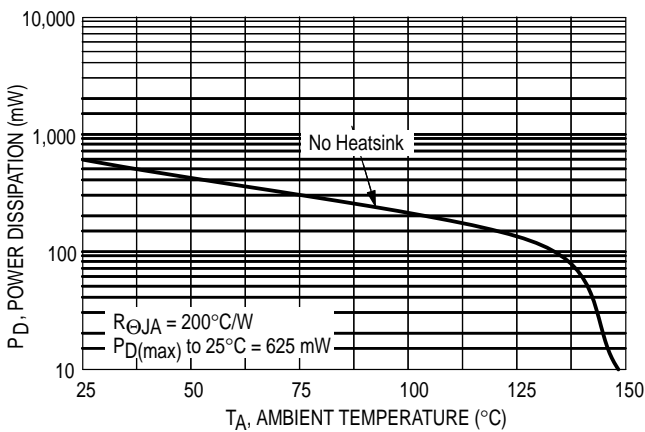
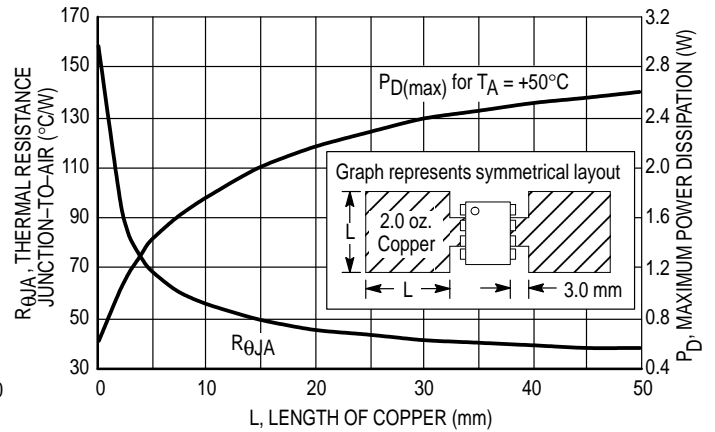
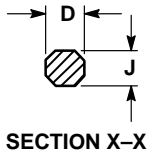
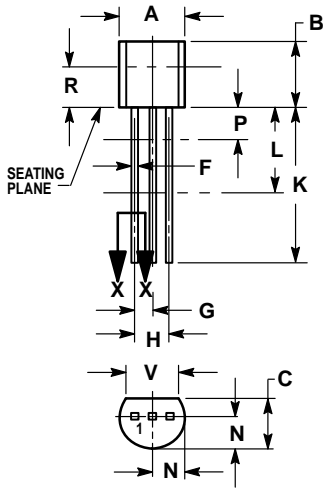

Figure 8. SOP-8 Thermal Resistance and Maximum Power Dissipation versus P.C.B. Copper Length



MC79L00, A Series OUTLINE DIMENSIONS

P SUFFIX PLASTIC PACKAGE CASE 29-04 ISSUE AD



- NOTES:
1. DIMENSIONING AND TOLERANCING PER ANSI Y14.5M, 1982.
 2. CONTROLLING DIMENSION: INCH.
 3. CONTOUR OF PACKAGE BEYOND DIMENSION R IS UNCONTROLLED.
 4. DIMENSION F APPLIES BETWEEN P AND L. DIMENSION D AND J APPLY BETWEEN L AND K MINIMUM. LEAD DIMENSION IS UNCONTROLLED IN P AND BEYOND DIMENSION K MINIMUM.

DIM	INCHES		MILLIMETERS	
	MIN	MAX	MIN	MAX
A	0.175	0.205	4.45	5.20
B	0.170	0.210	4.32	5.33
C	0.125	0.165	3.18	4.19
D	0.016	0.022	0.41	0.55
F	0.016	0.019	0.41	0.48
G	0.045	0.055	1.15	1.39
H	0.095	0.105	2.42	2.66
J	0.015	0.020	0.39	0.50
K	0.500	—	12.70	—
L	0.250	—	6.35	—
N	0.080	0.105	2.04	2.66
P	—	0.100	—	2.54
R	0.115	—	2.93	—
V	0.135	—	3.43	—

D SUFFIX PLASTIC PACKAGE CASE 751-05 (SOP-8) ISSUE R

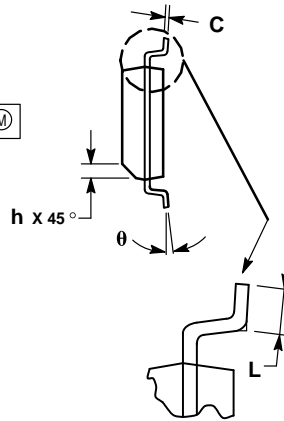
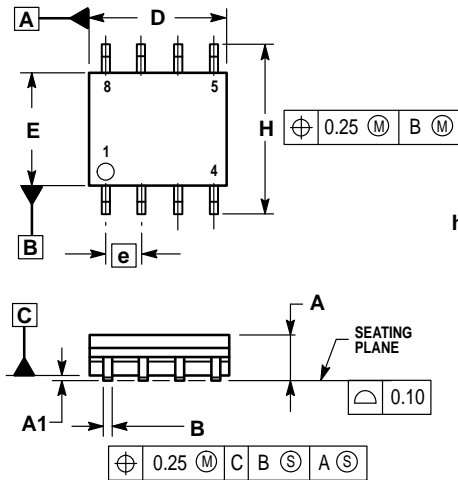

- NOTES:
1. DIMENSIONING AND TOLERANCING PER ASME Y14.5M, 1994.
 2. DIMENSIONS ARE IN MILLIMETERS.
 3. DIMENSION D AND E DO NOT INCLUDE MOLD PROTRUSION.
 4. MAXIMUM MOLD PROTRUSION 0.15 PER SIDE.
 5. DIMENSION B DOES NOT INCLUDE MOLD PROTRUSION. ALLOWABLE DAMBAR PROTRUSION SHALL BE 0.127 TOTAL IN EXCESS OF THE B DIMENSION AT MAXIMUM MATERIAL CONDITION.

DIM	MILLIMETERS	
	MIN	MAX
A	1.35	1.75
A1	0.10	0.25
B	0.35	0.49
C	0.18	0.25
D	4.80	5.00
E	3.80	4.00
e	1.27 BSC	
H	5.80	6.20
h	0.25	0.50
L	0.40	1.25
θ	0°	7°

Motorola reserves the right to make changes without further notice to any products herein. Motorola makes no warranty, representation or guarantee regarding the suitability of its products for any particular purpose, nor does Motorola assume any liability arising out of the application or use of any product or circuit, and specifically disclaims any and all liability, including without limitation consequential or incidental damages. "Typical" parameters which may be provided in Motorola data sheets and/or specifications can and do vary in different applications and actual performance may vary over time. All operating parameters, including "Typicals" must be validated for each customer application by customer's technical experts. Motorola does not convey any license under its patent rights nor the rights of others. Motorola products are not designed, intended, or authorized for use as components in systems intended for surgical implant into the body, or other applications intended to support or sustain life, or for any other application in which the failure of the Motorola product could create a situation where personal injury or death may occur. Should Buyer purchase or use Motorola products for any such unintended or unauthorized application, Buyer shall indemnify and hold Motorola and its officers, employees, subsidiaries, affiliates, and distributors harmless against all claims, costs, damages, and expenses, and reasonable attorney fees arising out of, directly or indirectly, any claim of personal injury or death associated with such unintended or unauthorized use, even if such claim alleges that Motorola was negligent regarding the design or manufacture of the part. Motorola and registered trademarks of Motorola, Inc. Motorola, Inc. is an Equal Opportunity/Affirmative Action Employer.

How to reach us:

USA/EUROPE/Locations Not Listed: Motorola Literature Distribution;
P.O. Box 20912; Phoenix, Arizona 85036. 1-800-441-2447 or 602-303-5454

MFAX: RMFAX0@email.sps.mot.com – TOUCHTONE 602-244-6609
INTERNET: <http://Design-NET.com>

JAPAN: Nippon Motorola Ltd.; Tatsumi-SPD-JLDC, 6F Seibu-Butsuryu-Center,
3-14-2 Tatsumi Koto-Ku, Tokyo 135, Japan. 03-81-3521-8315

ASIA/PACIFIC: Motorola Semiconductors H.K. Ltd.; 8B Tai Ping Industrial Park,
51 Ting Kok Road, Tai Po, N.T., Hong Kong. 852-26629298

