

## MM74C00 • MM74C02 • MM74C04

### Quad 2-Input NAND Gate • Quad 2-Input NOR Gate • Hex Inverter

#### General Description

The MM74C00, MM74C02, and MM74C04 logic gates employ complementary MOS (CMOS) to achieve wide power supply operating range, low power consumption, high noise immunity and symmetric controlled rise and fall times. With features such as this the 74C logic family is close to ideal for use in digital systems. Function and pin out compatibility with series 74 devices minimizes design time for those designers already familiar with the standard 74 logic family.

All inputs are protected from damage due to static discharge by diode clamps to  $V_{CC}$  and GND.

#### Features

- Wide supply voltage range: 3V to 15V
- Guaranteed noise margin: 1V
- High noise immunity:  $0.45 V_{CC}$  (typ.)
- Low power consumption: 10 nW/package (typ.)
- Low power: TTL compatibility:  
Fan out of 2 driving 74L

#### Ordering Code:

Order Number	Package Number	Package Description
MM74C00M	M14A	14-Lead Small Outline Integrated Circuit (SOIC), JEDEC MS-120, 0.150" Narrow
MM74C00N	N14A	14-Lead Plastic Dual-In-Line Package (PDIP), JEDEC MS-001, 0.300" Wide
MM74C02N	M14A	14-Lead Small Outline Integrated Circuit (SOIC), JEDEC MS-120, 0.150" Narrow
MM74C04M	M14A	14-Lead Small Outline Integrated Circuit (SOIC), JEDEC MS-120, 0.150" Narrow
MM74C04N	N14A	14-Lead Plastic Dual-In-Line Package (PDIP), JEDEC MS-001, 0.300" Wide

Device also available in Tape and Reel. Specify by appending suffix letter "X" to the ordering code.

#### Connection Diagrams

Pin Assignments for DIP and SOIC

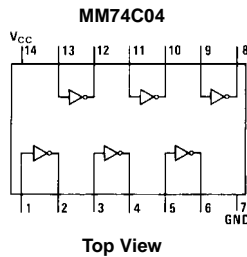
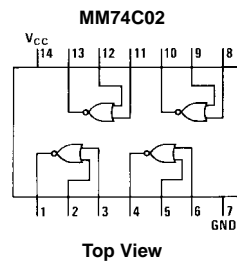
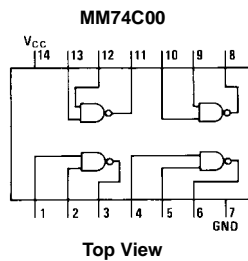

Absolute Maximum Ratings (Note 1)		Lead Temperature (Soldering, 10 seconds)	300°C
Voltage at Any Pin	-0.3V to $V_{CC} + 0.3V$		
Operating Temperature Range	-40°C to +85°C		
Storage Temperature Range	-65°C to +150°C		
Operating $V_{CC}$ Range	3.0V to 15V		
Maximum $V_{CC}$ Voltage	18V		
Power Dissipation ( $P_D$ )			
Dual-In-Line	700 mW		
Small Outline	500 mW		

**Note 1:** "Absolute Maximum Ratings" are those values beyond which the safety of the device cannot be guaranteed. Except for "Operating Temperature Range" they are not meant to imply that the devices should be operated at these limits. The table of "Electrical Characteristics" provides conditions for actual device operation.

## DC Electrical Characteristics

Min/Max limits apply across the guaranteed temperature range unless otherwise noted

Symbol	Parameter	Conditions	Min	Typ	Max	Units
<b>CMOS TO CMOS</b>						
$V_{IN(1)}$	Logical "1" Input Voltage	$V_{CC} = 5.0V$	3.5			V
		$V_{CC} = 10V$	8.0			V
$V_{IN(0)}$	Logical "0" Input Voltage	$V_{CC} = 5.0V$			1.5	V
		$V_{CC} = 10V$			2.0	V
$V_{OUT(1)}$	Logical "1" Output Voltage	$V_{CC} = 5.0V, I_O = -10 \mu A$	4.5			V
		$V_{CC} = 10V, I_O = -10 \mu A$	9.0			V
$V_{OUT(0)}$	Logical "0" Output Voltage	$V_{CC} = 5.0V, I_O = 10 \mu A$			0.5	V
		$V_{CC} = 10V, I_O = 10 \mu A$			1.0	V
$I_{IN(1)}$	Logical "1" Input Current	$V_{CC} = 15V, V_{IN} = 15V$		0.005	1.0	$\mu A$
$I_{IN(0)}$	Logical "0" Input Current	$V_{CC} = 15V, V_{IN} = 0V$	-1.0	-0.005		$\mu A$
$I_{CC}$	Supply Current	$V_{CC} = 15V$		0.01	15	$\mu A$
<b>LOW POWER TO CMOS</b>						
$V_{IN(1)}$	Logical "1" Input Voltage	74C, $V_{CC} = 4.75V$	$V_{CC} - 1.5$			V
$V_{IN(0)}$	Logical "0" Input Voltage	74C, $V_{CC} = 4.75V$			0.8	V
$V_{OUT(1)}$	Logical "1" Output Voltage	74C, $V_{CC} = 4.75V, I_O = -10 \mu A$	4.4			V
$V_{OUT(0)}$	Logical "0" Output Voltage	74C, $V_{CC} = 4.75V, I_O = 10 \mu A$			0.4	V
<b>CMOS TO LOW POWER</b>						
$V_{IN(1)}$	Logical "1" Input Voltage	74C, $V_{CC} = 4.75V$	4.0			V
$V_{IN(0)}$	Logical "0" Input Voltage	74C, $V_{CC} = 4.75V$			1.0	V
$V_{OUT(1)}$	Logical "1" Output Voltage	74C, $V_{CC} = 4.75V, I_O = -360 \mu A$	2.4			V
$V_{OUT(0)}$	Logical "0" Output Voltage	74C, $V_{CC} = 4.75V, I_O = 360 \mu A$			0.4	V
<b>OUTPUT DRIVE (see Family Characteristics Data Sheet) <math>T_A = 25^\circ C</math> (short circuit current)</b>						
$I_{SOURCE}$	Output Source Current	$V_{CC} = 5.0V, V_{IN(0)} = 0V, V_{OUT} = 0V$	-1.75			mA
$I_{SOURCE}$	Output Source Current	$V_{CC} = 10V, V_{IN(0)} = 0V, V_{OUT} = 0V$	-8.0			mA
$I_{SINK}$	Output Sink Current	$V_{CC} = 5.0V, V_{IN(1)} = 5.0V, V_{OUT} = V_{CC}$	1.75			mA
$I_{SINK}$	Output Sink Current	$V_{CC} = 10V, V_{IN(1)} = 10V, V_{OUT} = V_{CC}$	8.0			mA

## AC Electrical Characteristics (Note 2)

$T_A = 25^\circ C, C_L = 50 \text{ pF}$ , unless otherwise specified

Symbol	Parameter	Conditions	Min	Typ	Max	Units
<b>MM74C00, MM74C02, MM74C04</b>						
$t_{pd0}, t_{pd1}$	Propagation Delay Time to Logical "1" or "0"	$V_{CC} = 5.0V$		50	90	ns
		$V_{CC} = 10V$		30	60	ns
$C_{IN}$	Input Capacitance	(Note 3)		6.0		pF
$C_{PD}$	Power Dissipation Capacitance	Per Gate or Inverter (Note 4)		12		pF

**Note 2:** AC Parameters are guaranteed by DC correlated testing.

**Note 3:** Capacitance is guaranteed by periodic testing.

**Note 4:**  $C_{PD}$  determines the no load AC power consumption of any CMOS device. For complete explanation see Family Characteristics Application Note—AN-90.

## Typical Performance Characteristics

Gate Transfer Characteristics

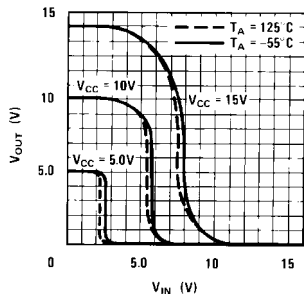

Guaranteed Noise Margin Over Temperature vs  $V_{CC}$

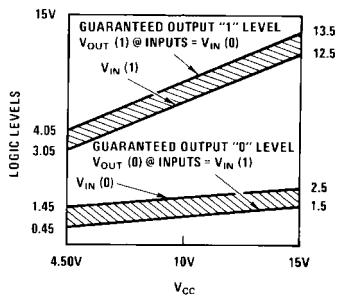

Power Dissipation vs Frequency  
MM74C00, MM74C02, MM74C04

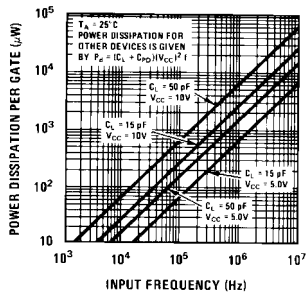

Propagation Delay vs Ambient Temperature  
MM74C00, MM74C02, MM74C04

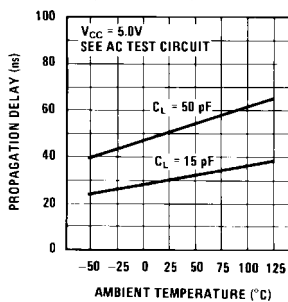

Propagation Delay vs Ambient Temperature  
MM74C00, MM74C02, MM74C04

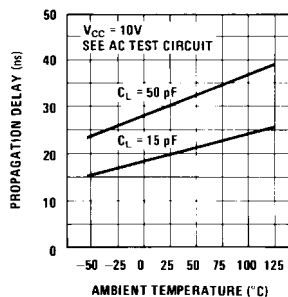

Propagation Delay Time vs Load Capacitance  
MM74C00, MM74C02, MM74C04

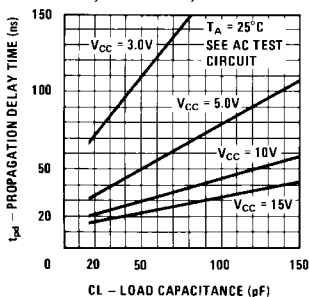

### Switching Time Waveforms and AC Test Circuit

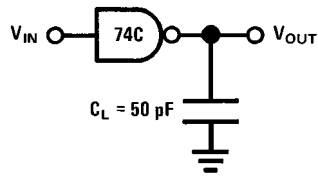
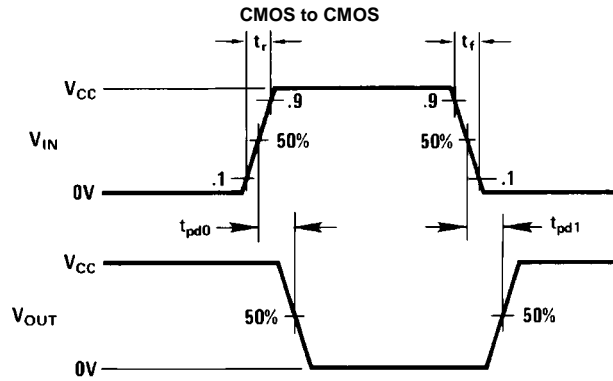

Delays measured with input  $t_r$ ,  $t_f \leq 20 \text{ ns}$ .

**Physical Dimensions** inches (millimeters) unless otherwise noted

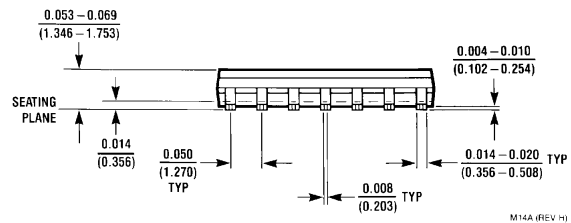
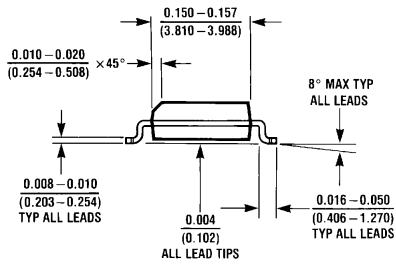
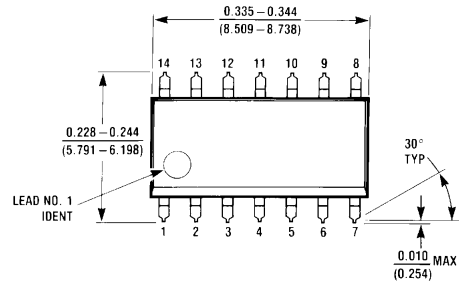

**14-Lead Small Outline Integrated Circuit (SOIC), JEDEC MS-120, 0.150" Narrow  
Package Number M14A**

M14A (REV H)

**Physical Dimensions** inches (millimeters) unless otherwise noted (Continued)

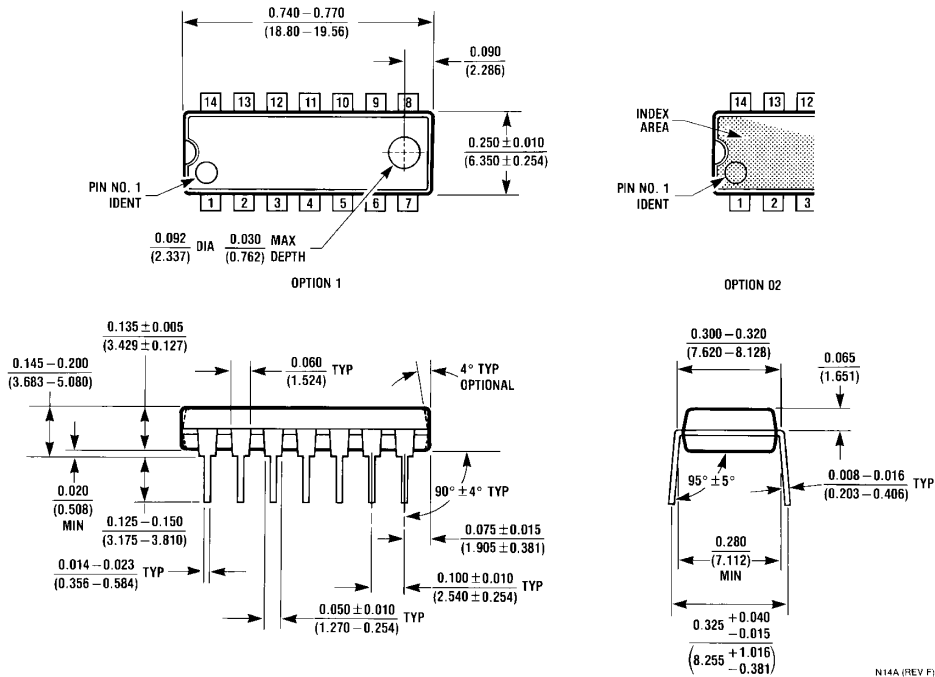

14-Lead Plastic Dual-In-Line Package (PDIP), JEDEC MS-001, 0.300" Wide Package Number N14A

**LIFE SUPPORT POLICY**

FAIRCHILD'S PRODUCTS ARE NOT AUTHORIZED FOR USE AS CRITICAL COMPONENTS IN LIFE SUPPORT DEVICES OR SYSTEMS WITHOUT THE EXPRESS WRITTEN APPROVAL OF THE PRESIDENT OF FAIRCHILD SEMICONDUCTOR CORPORATION. As used herein:

1. Life support devices or systems are devices or systems which, (a) are intended for surgical implant into the body, or (b) support or sustain life, and (c) whose failure to perform when properly used in accordance with instructions for use provided in the labeling, can be reasonably expected to result in a significant injury to the user.
2. A critical component in any component of a life support device or system whose failure to perform can be reasonably expected to cause the failure of the life support device or system, or to affect its safety or effectiveness.

[www.fairchildsemi.com](http://www.fairchildsemi.com)