

MM74HCU04 Hex Inverter

General Description

The MM74HCU04 inverters utilize advanced silicon-gate CMOS technology to achieve operating speeds similar to LS-TTL gates with the low power consumption of standard CMOS integrated circuits.

The MM74HCU04 is an unbuffered inverter. It has high noise immunity and the ability to drive 15 LS-TTL loads. The 74HCU logic family is functionally as well as pin-out compatible with the standard 74LS logic family. All inputs

are protected from damage due to static discharge by internal diode clamps to V_{CC} and ground.

Features

- Typical propagation delay: 7 ns
- Fanout of 15 LS-TTL loads
- Quiescent power consumption: 10 μ A maximum at room temperature
- Low input current: 1 μ A maximum

Ordering Code:

Order Number	Package Number	Package Description
MM74HCU04M	M14A	14-Lead Small Outline Integrated Circuit (SOIC), JEDEC MS-120, 0.150" Narrow
MM74HCU04SJ	M14D	14-Lead Small Outline Package (SOP), EIAJ TYPE II, 5.3mm Wide
MM74HCU04MTC	MTC14	14-Lead Thin Shrink Small Outline Package (TSSOP), JEDEC MO-153, 4.4mm Wide
MM74HCU04N	N14A	14-Lead Plastic Dual-In-Line Package (PDIP), JEDEC MS-001, 0.300" Wide

Devices also available in Tape and Reel. Specify by appending the suffix letter "X" to the ordering code.

Connection Diagram

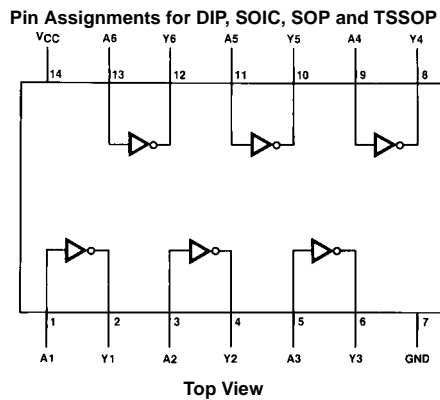

Schematic Diagram

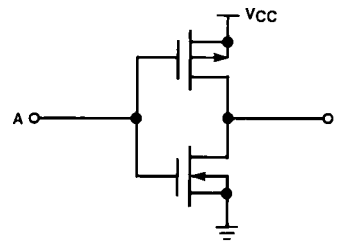

Absolute Maximum Ratings (Note 1)

(Note 2)

Supply Voltage (V_{CC})	-0.5 to +7.0V
DC Input Voltage (V_{IN})	-1.5 to $V_{CC}+1.5V$
DC Output Voltage (V_{OUT})	-0.5 to $V_{CC}+0.5V$
Clamp Diode Current (I_{IK}, I_{OK})	± 20 mA
DC Output Current, per pin (I_{OUT})	± 25 mA
DC V_{CC} or GND Current, per pin (I_{CC})	± 50 mA
Storage Temperature Range (T_{STG})	-65°C to +150°C
Power Dissipation (P_D)	
(Note 3)	600 mW
S.O. Package only	500 mW
Lead Temperature (T_L)	
(Soldering 10 seconds)	260°C

Recommended Operating Conditions

	Min	Max	Units
Supply Voltage (V_{CC})	2	6	V
DC Input or Output Voltage (V_{IN}, V_{OUT})	0	V_{CC}	V
Operating Temperature Range (T_A)	-40	+85	°C

Note 1: Absolute Maximum Ratings are those values beyond which damage to the device may occur.**Note 2:** Unless otherwise specified all voltages are referenced to ground.**Note 3:** Power Dissipation temperature derating — plastic "N" package: -12 mW/°C from 65°C to 85°C.**DC Electrical Characteristics** (Note 4)

Symbol	Parameter	Conditions	V_{CC}	$T_A = 25^\circ\text{C}$			Units	
				Typ	Guaranteed Limits			
V_{IH}	Minimum HIGH Level Input Voltage		2.0V		1.7	1.7	V	
			4.5V		3.6	3.6	V	
			6.0V		4.8	4.8	V	
V_{IL}	Maximum LOW Level Input Voltage		2.0V		0.3	0.3	V	
			4.5V		0.8	0.8	V	
			6.0V		1.1	1.1	V	
V_{OH}	Minimum HIGH Level Output Voltage	$V_{IN} = V_{IL}$ $ I_{OUT} \leq 20 \mu\text{A}$	2.0V	2.0	1.8	1.8	V	
			4.5V	4.5	4.0	4.0	V	
			6.0V	6.0	5.5	5.5	V	
		$V_{IN} = \text{GND}$ $ I_{OUT} \leq 4.0 \text{ mA}$ $ I_{OUT} \leq 5.2 \text{ mA}$	4.5V	4.2	3.98	3.84	3.7	V
			6.0V	5.7	5.48	5.34	5.2	V
V_{OL}	Maximum LOW Level Output Voltage	$V_{IN} = V_{IH}$ $ I_{OUT} \leq 20 \mu\text{A}$	2.0V	0	0.2	0.2	V	
			4.5V	0	0.5	0.5	V	
			6.0V	0	0.5	0.5	V	
		$V_{IN} = V_{CC}$ $ I_{OUT} \leq 6.0 \text{ mA}$ $ I_{OUT} \leq 7.8 \text{ mA}$	4.5V	0.2	0.26	0.33	0.4	V
			6.0V	0.2	0.26	0.33	0.4	V
I_{IN}	Maximum Input Current	$V_{IN} = V_{CC}$ or GND	6.0V		± 0.1	± 1.0	± 1.0	μA
I_{CC}	Maximum Quiescent Supply Current	$V_{IN} = V_{CC}$ or GND $I_{OUT} = 0 \mu\text{A}$	6.0V		2.0	20	40	μA

Note 4: For a power supply of $5V \pm 10\%$ the worst case output voltages (V_{OH} and V_{OL}) occur for HC at 4.5V. Thus the 4.5V values should be used when designing with this supply. Worst case V_{IH} and V_{IL} occur at $V_{CC} = 5.5V$ and 4.5V respectively. (The V_{IH} value at 5.5V is 3.85V.) The worst case leakage current (I_{IN} , I_{CC} , and I_{OZ}) occur for CMOS at the higher voltage and so the 6.0V values should be used.

AC Electrical Characteristics

$V_{CC} = 5V$, $T_A = 25^\circ C$, $C_L = 15\text{ pF}$, $t_r = t_f = 6\text{ ns}$

Symbol	Parameter	Conditions	Typ	Guaranteed Limit	Units
t_{PHL} , t_{PLH}	Maximum Propagation Delay		7	13	ns

AC Electrical Characteristics

$V_{CC} = 2.0V$ to $6.0V$, $C_L = 50\text{ pF}$, $t_r = t_f = 6\text{ ns}$ (unless otherwise specified)

Symbol	Parameter	Conditions	V_{CC}	$T_A = 25^\circ C$		$T_A = -40$ to $85^\circ C$	$T_A = -55$ to $125^\circ C$	Units
				Typ	Guaranteed Limits			
t_{PHL} , t_{PLH}	Maximum Propagation Delay		2.0V	49	82	103	120	ns
			4.5V	9.9	16	21	24	ns
			6.0V	8.4	14	18	20	ns
t_{TLH} , t_{THL}	Maximum Output Rise and Fall Time		2.0V	30	75	95	110	ns
			4.5V	8	15	19	22	ns
			6.0V	7	13	16	19	ns
C_{PD}	Power Dissipation Capacitance (Note 5)	(per gate)		90				pF
C_{IN}	Maximum Input Capacitance			8	15	15	15	pF

Note 5: C_{PD} determines the no load dynamic power consumption, $P_D = C_{PD} V_{CC}^2 f + I_{CC} V_{CC}$, and the no load dynamic current consumption, $I_S = C_{PD} V_{CC} f + I_{CC}$.

Typical Applications

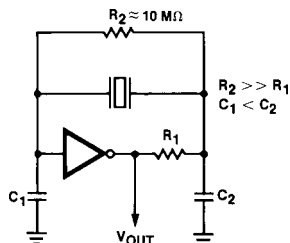

FIGURE 1. Crystal Oscillator

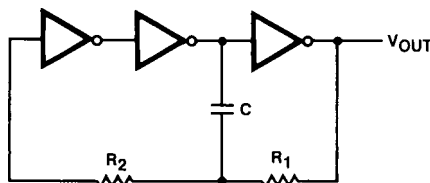

FIGURE 2. Stable RC Oscillator

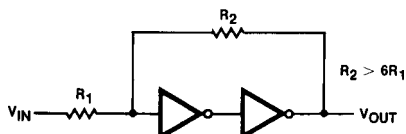
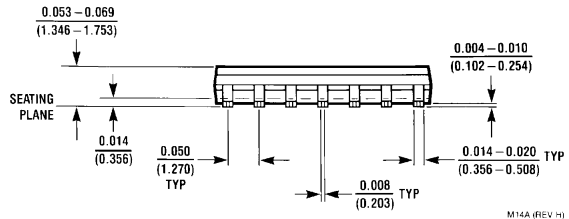
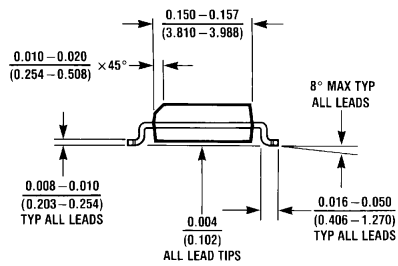
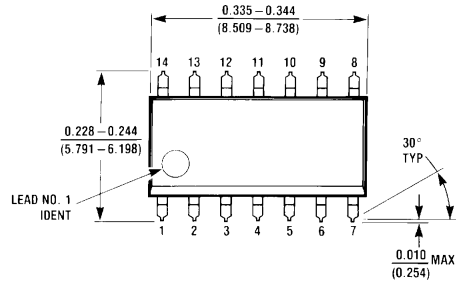
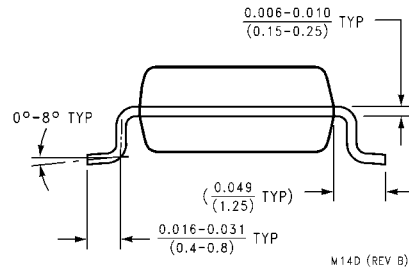
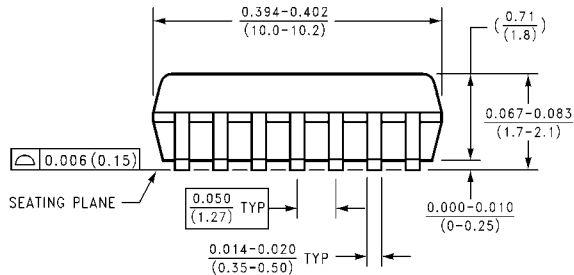
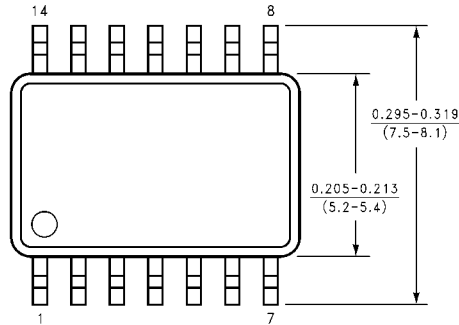

FIGURE 3. Schmitt Trigger

Physical Dimensions inches (millimeters) unless otherwise noted



14-Lead Small Outline Integrated Circuit (SOIC), JEDEC MS-120, 0.150" Narrow Package Number M14A



14-Lead Small Outline Package (SOP), EIAJ TYPE II, 5.3mm Wide Package Number M14D

Physical Dimensions inches (millimeters) unless otherwise noted (Continued)

14LD, TSSOP, JEDEC MO-153, 4.4MM WIDE

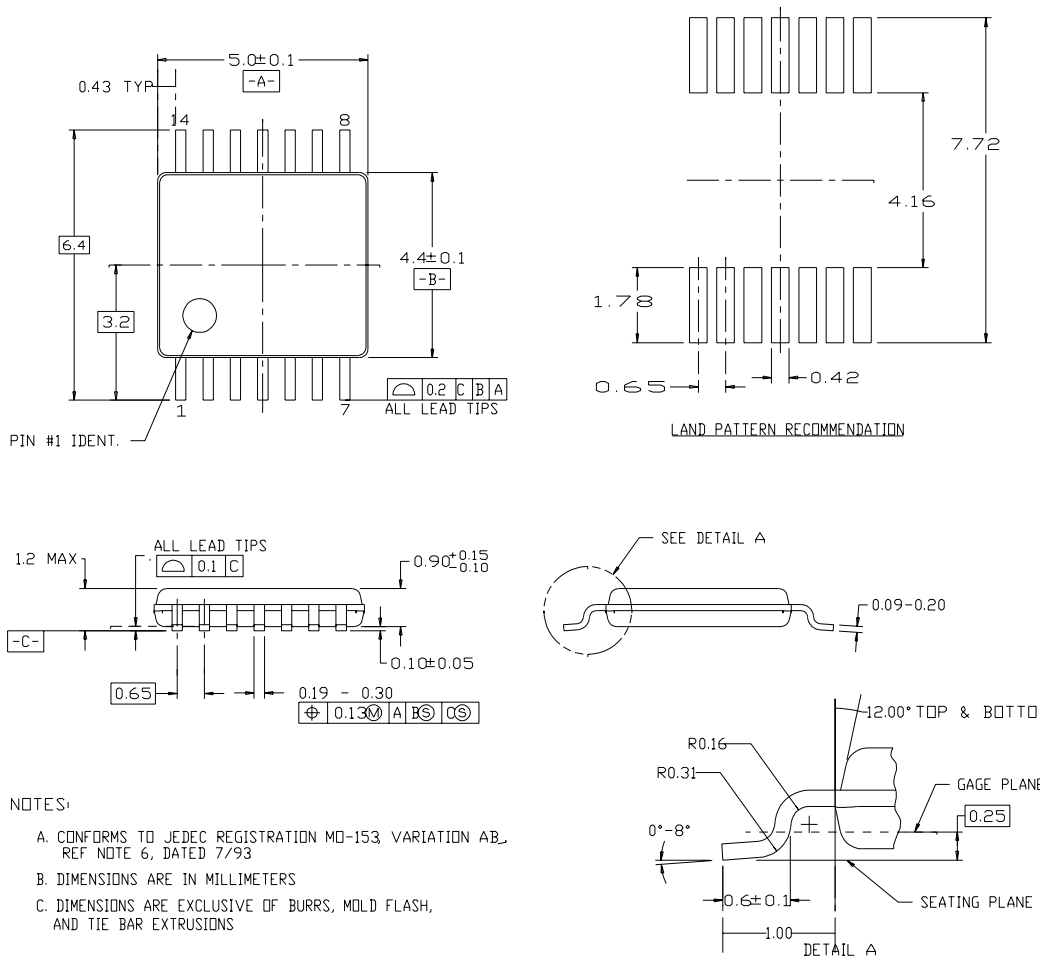

**14-Lead Thin Shrink Small Outline Package (TSSOP), JEDEC MO-153, 4.4mm Wide
Package Number MTC14**

Physical Dimensions inches (millimeters) unless otherwise noted (Continued)

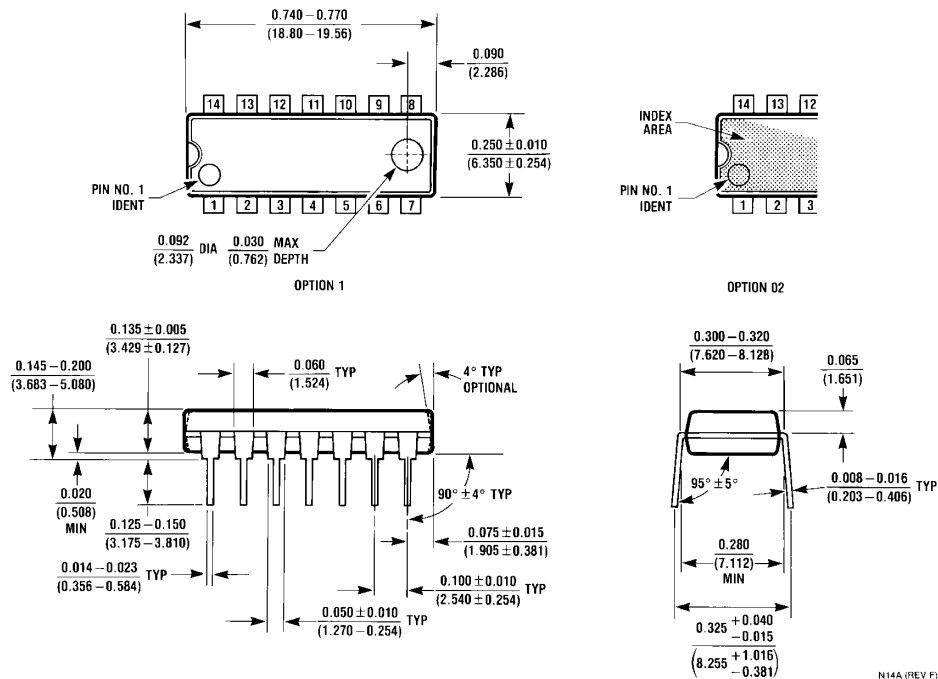

LIFE SUPPORT POLICY

FAIRCHILD'S PRODUCTS ARE NOT AUTHORIZED FOR USE AS CRITICAL COMPONENTS IN LIFE SUPPORT DEVICES OR SYSTEMS WITHOUT THE EXPRESS WRITTEN APPROVAL OF THE PRESIDENT OF FAIRCHILD SEMICONDUCTOR CORPORATION. As used herein:

1. Life support devices or systems are devices or systems which, (a) are intended for surgical implant into the body, or (b) support or sustain life, and (c) whose failure to perform when properly used in accordance with instructions for use provided in the labeling, can be reasonably expected to result in a significant injury to the user.
2. A critical component in any component of a life support device or system whose failure to perform can be reasonably expected to cause the failure of the life support device or system, or to affect its safety or effectiveness.

www.fairchildsemi.com