

PNA2602M

Darlington Phototransistor

For optical control systems

■ Features

- Darlington output, high sensitivity
- Easy to combine light emission and photodetection on same printed circuit board
- Small size, thin side-view type package
- Long lead and visible light cutoff design with PN205

■ Absolute Maximum Ratings (Ta = 25°C)

Parameter	Symbol	Rated	Unit
Collector to emitter voltage	V_{CEO}	20	V
Emitter to collector voltage	V_{ECO}	5	V
Collector current	I_C	30	mA
Collector power dissipation	P_C	100	mW
Operating ambient temperature	T_{opr}	-25 to +80	°C
Storage temperature	T_{stg}	-30 to +100	°C

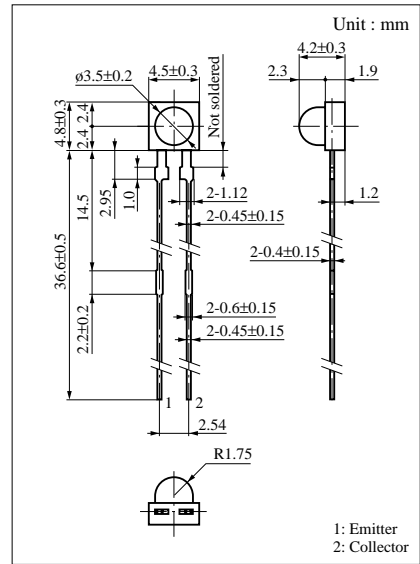

■ Electro-Optical Characteristics (Ta = 25°C)

Parameter	Symbol	Conditions	min	typ	max	Unit
Dark current	I_{CEO}	$V_{CE} = 10V$			0.5	μA
Sensitivity to infrared emitters	S_{IR}^{*1}	$V_{CE} = 10V, H = 3.75 \mu W/cm^2$	0.1		3.0	mA
Peak sensitivity wavelength	λ_p	$V_{CE} = 10V$		850		nm
Acceptance half angle	θ	Measured from the optical axis to the half power point		35		deg.
Response time	t_r, t_f^{*2}	$V_{CC} = 10V, I_C = 1mA, R_L = 100\Omega$		150		μs
Collector saturation voltage	$V_{CE(sat)}^{*1}$	$I_C = 100\mu A, H = 3.75 \mu W/cm^2$			1.5	V

*1 Measurements were made using infrared light ($\lambda = 940 \text{ nm}$) as a light source.

*2 Switching time measurement circuit

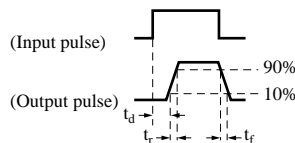
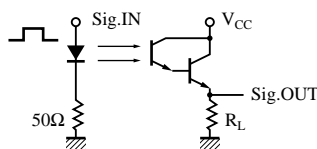

t_d : Delay time

t_r : Rise time (Time required for the collector photo current to increase from 10% to 90% of its final value)

t_f : Fall time (Time required for the collector photo current to decrease from 90% to 10% of its initial value)

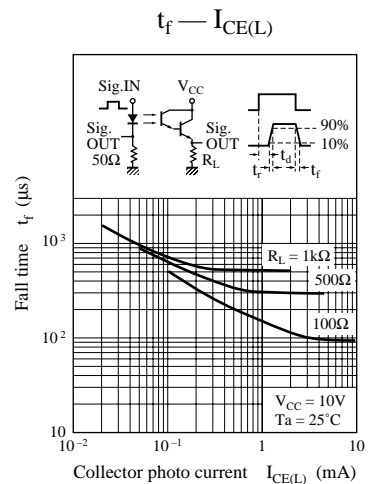
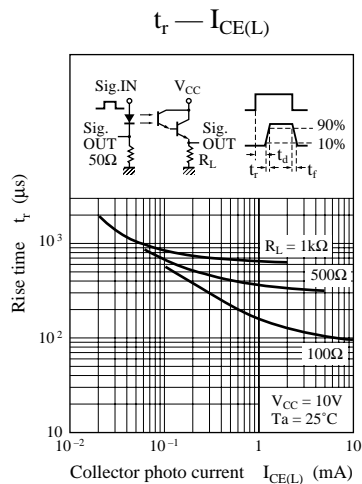
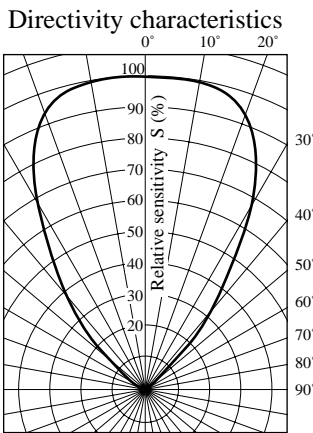
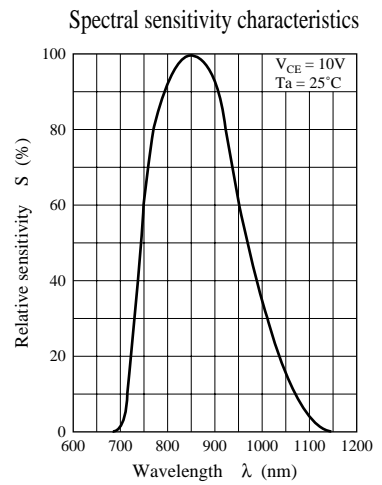
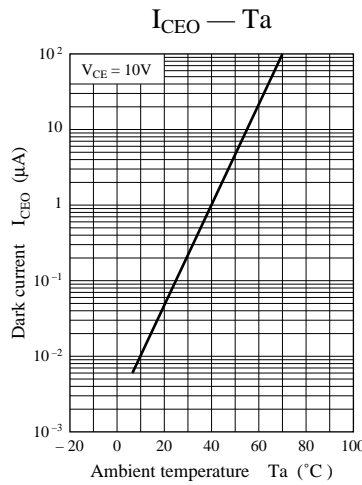
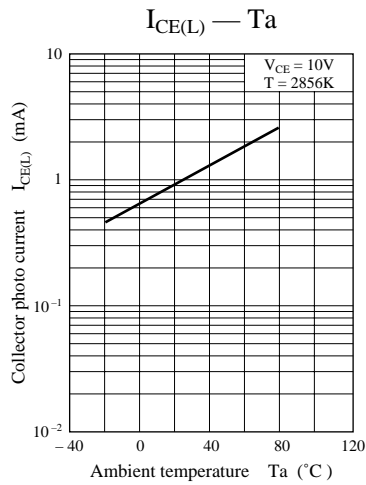
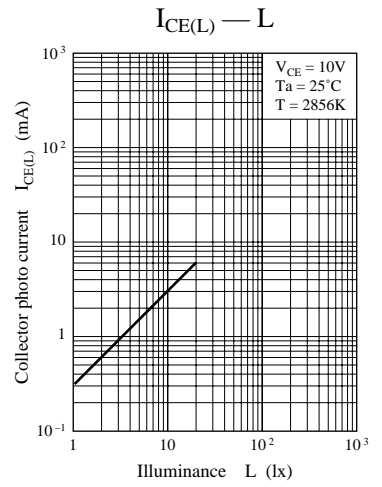
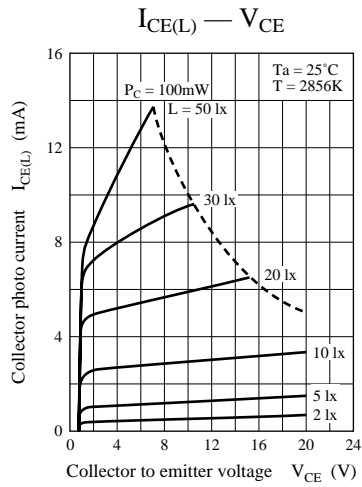
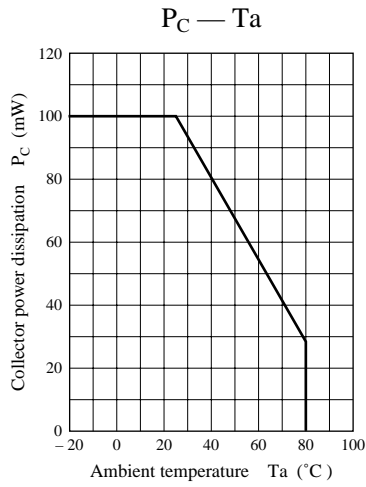

This datasheet has been download from:

www.datasheetcatalog.com

Datasheets for electronics components.