

TOSHIBA Transistor Silicon NPN Epitaxial Type (PCT Process)

RN1970,RN1971

Switching, Inverter Circuit, Interface Circuit
And Driver Circuit Applications

Unit in mm

- Including two devices in US6 (ultra super mini type 6 leads)
- With built-in bias resistors
- Simplify circuit design
- Reduce a quantity of parts and manufacturing process
- Complementary to RN2970~RN2971

Equivalent Circuit

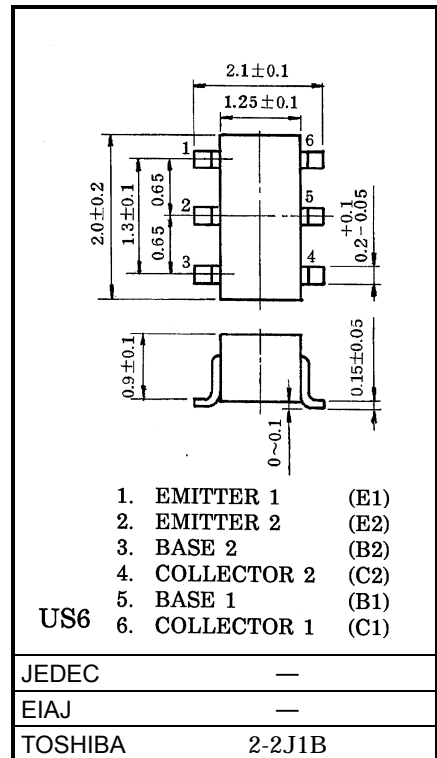
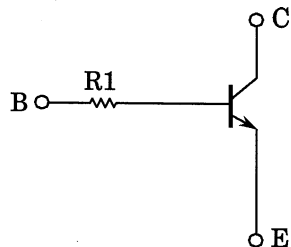

Weight: 6.8mg

Maximum Ratings (Ta = 25°C) (Q1, Q2 Common)

Characterisitic	Symbol	Rating	Unit
Collector-base voltage	V_{CB0}	50	V
Collector-emitter voltage	V_{CEO}	50	V
Emitter-base voltage	V_{EBO}	5	V
Collector current	I_C	100	mA
Collector power dissipation	P_C^*	200	mW
Junction temperature	T_j	150	°C
Storage temperature range	T_{stg}	-55~150	°C

*: Total rating

Equivalent Circuit (Top View)

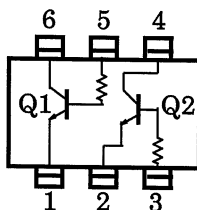

961001EAA2

● TOSHIBA is continually working to improve the quality and the reliability of its products. Nevertheless, semiconductor devices in general can malfunction or fail due to their inherent electrical sensitivity and vulnerability to physical stress. It is the responsibility of the buyer, when utilizing TOSHIBA products, to observe standards of safety, and to avoid situations in which a malfunction or failure of a TOSHIBA product could cause loss of human life, bodily injury or damage to property. In developing your designs, please ensure that TOSHIBA products are used within specified operating ranges as set forth in the most recent products specifications. Also, please keep in mind the precautions and conditions set forth in the TOSHIBA Semiconductor Reliability Handbook.

Electrical Characteristics (Ta = 25°C) (Q1, Q2 Common)

Characteristic	Symbol	Test Circuit	Test Condition	Min	Typ.	Max	Unit
Collector cut-off current	I_{CBO}	—	$V_{CB} = 5V, I_E = 0$	—	—	100	nA
Emitter cut-off current	I_{EBO}	—	$V_{EB} = 5V, I_C = 0$	—	—	100	nA
DC current gain	h_{FE}	—	$V_{CE} = 5V, I_C = 1mA$	120	—	700	—
Collector-emitter saturation voltage	$V_{CE(sat)}$	—	$I_C = 5mA, I_B = 0.25mA$	—	0.1	0.3	V
Translation frequency	f_T	—	$V_{CE} = 10V, I_C = 5mA$	—	250	—	MHz
Collector output capacitance	C_{ob}	—	$V_{CB} = 10V, I_E = 0, f = 1MHz$	—	3	6	pF
Input resistor	RN1970	R1	—	3.29	4.7	6.11	kΩ
	RN1971			7	10	13	

(Q1, Q2 Common)

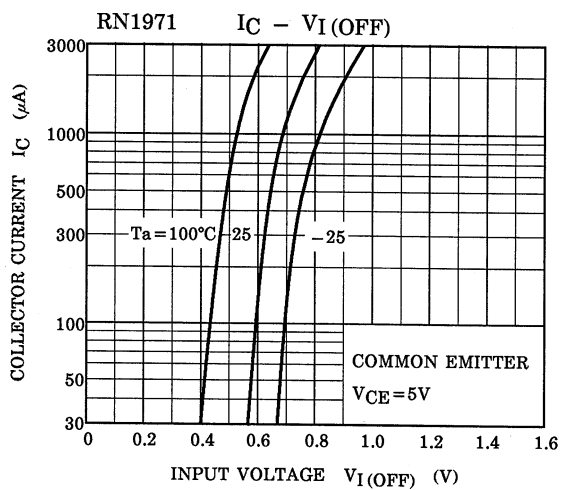
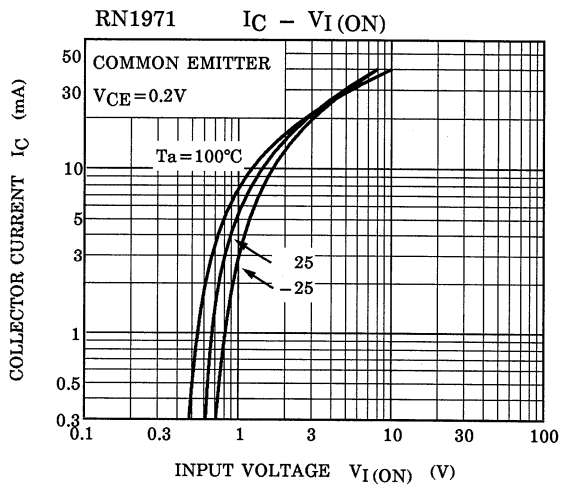
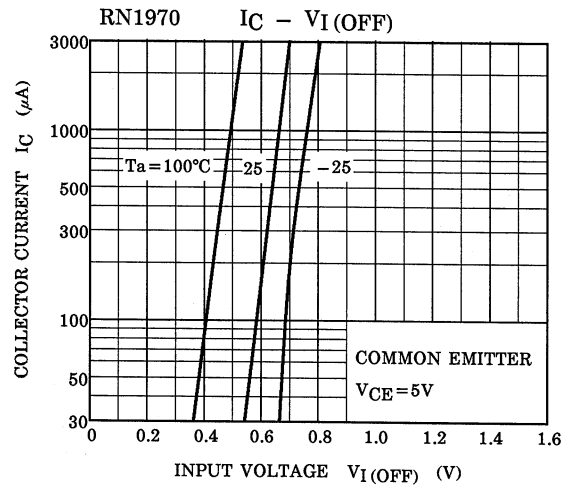
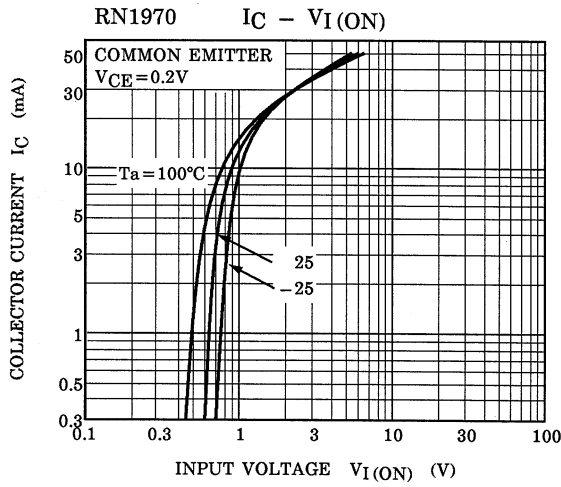

961001EAA2

- The information contained herein is presented only as a guide for the applications of our products. No responsibility is assumed by TOSHIBA CORPORATION for any infringements of intellectual property or other rights of the third parties which may result from its use. No license is granted by implication or otherwise under any intellectual property or other rights of TOSHIBA CORPORATION or others.
- The information contained herein is subject to change without notice.

(Q1, Q2 Common)

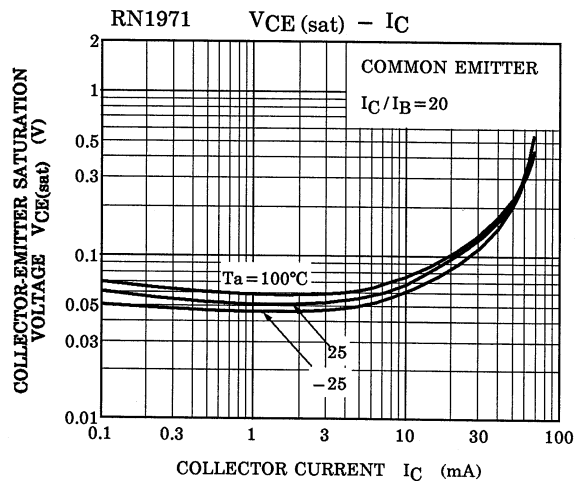
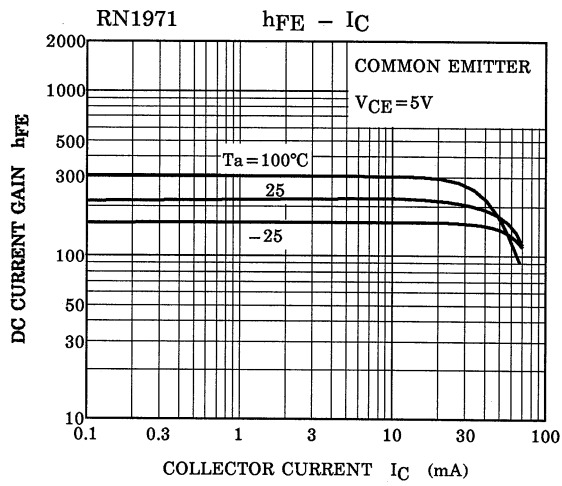
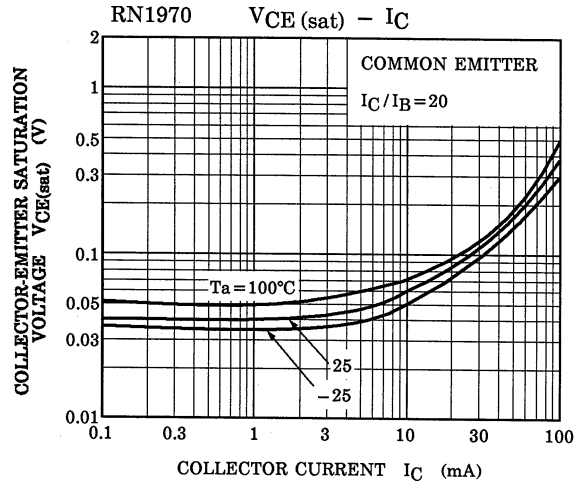
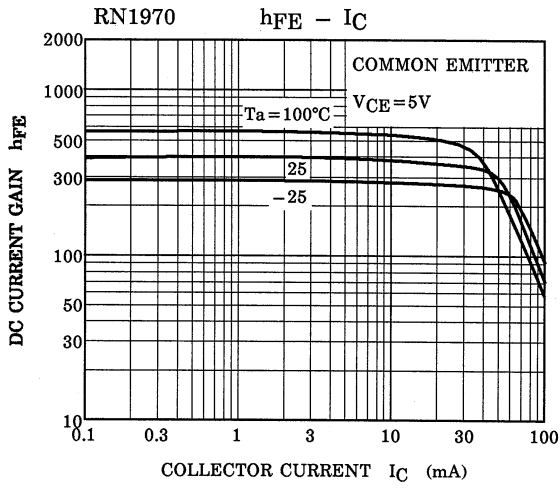

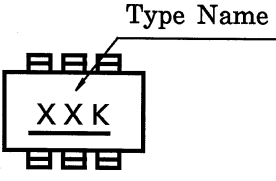
Type Name	Marking
RN1970	
RN1971	