

SHINDENGEN

Super Fast Recovery Rectifiers

Single

S2L40

400V 1.1A

FEATURES

- Low noise
- trr50ns
- Applicable to Automatic Insertion

APPLICATION

- Switching power supply
- Free Wheel
- Home Appliances, Office Equipment
- Telecommunication, Factory Automation

OUTLINE DIMENSIONS

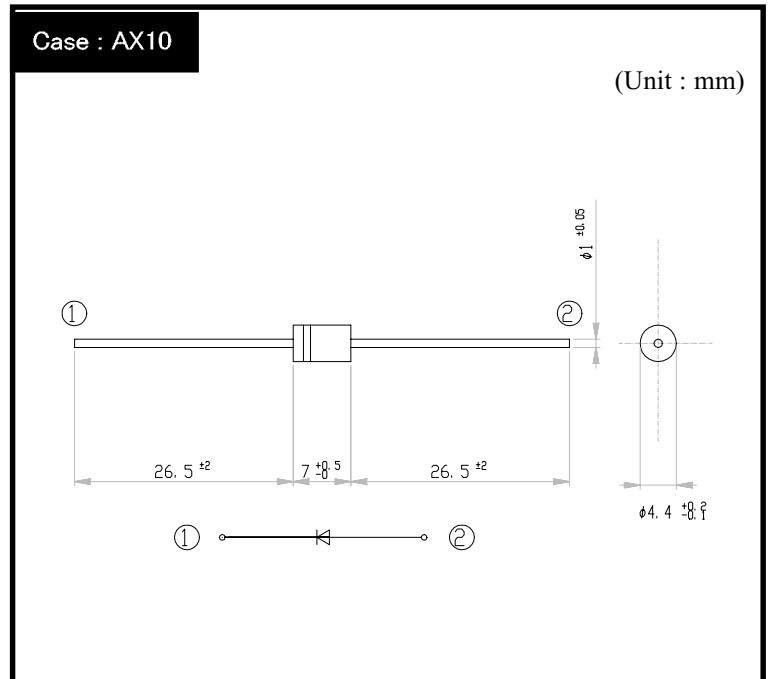

RATINGS

● Absolute Maximum Ratings (If not specified Tl=25°C)

Item	Symbol	Conditions	Ratings	Unit
Storage Temperature	T _{stg}		-55~150	°C
Operating Junction Temperature	T _j		150	°C
Maximum Reverse Voltage	V _{RM}		400	V
Average Rectified Forward Current	I _O	50Hz sine wave, R-load, T _a =25°C	1.1	A
Peak Surge Forward Current	I _{FSM}	50Hz sine wave, Non-repetitive 1 cycle peak value, T _j =25°C	40	A

● Electrical Characteristics (If not specified Tl=25°C)

Item	Symbol	Conditions	Ratings	Unit
Forward Voltage	V _F	I _F =1.1A, Pulse measurement	Max.1.3	V
Reverse Current	I _R	V _R =V _{RM} , Pulse measurement	Max.10	μA
Reverse Recovery Time	t _{rr}	I _F =0.5A, I _R =1A	Max.50	ns
Thermal Resistance	θ _{jl}	junction to lead	Max.12	°C/W
	θ _{ja}	junction to ambient	Max.83	

S2L40

Forward Voltage

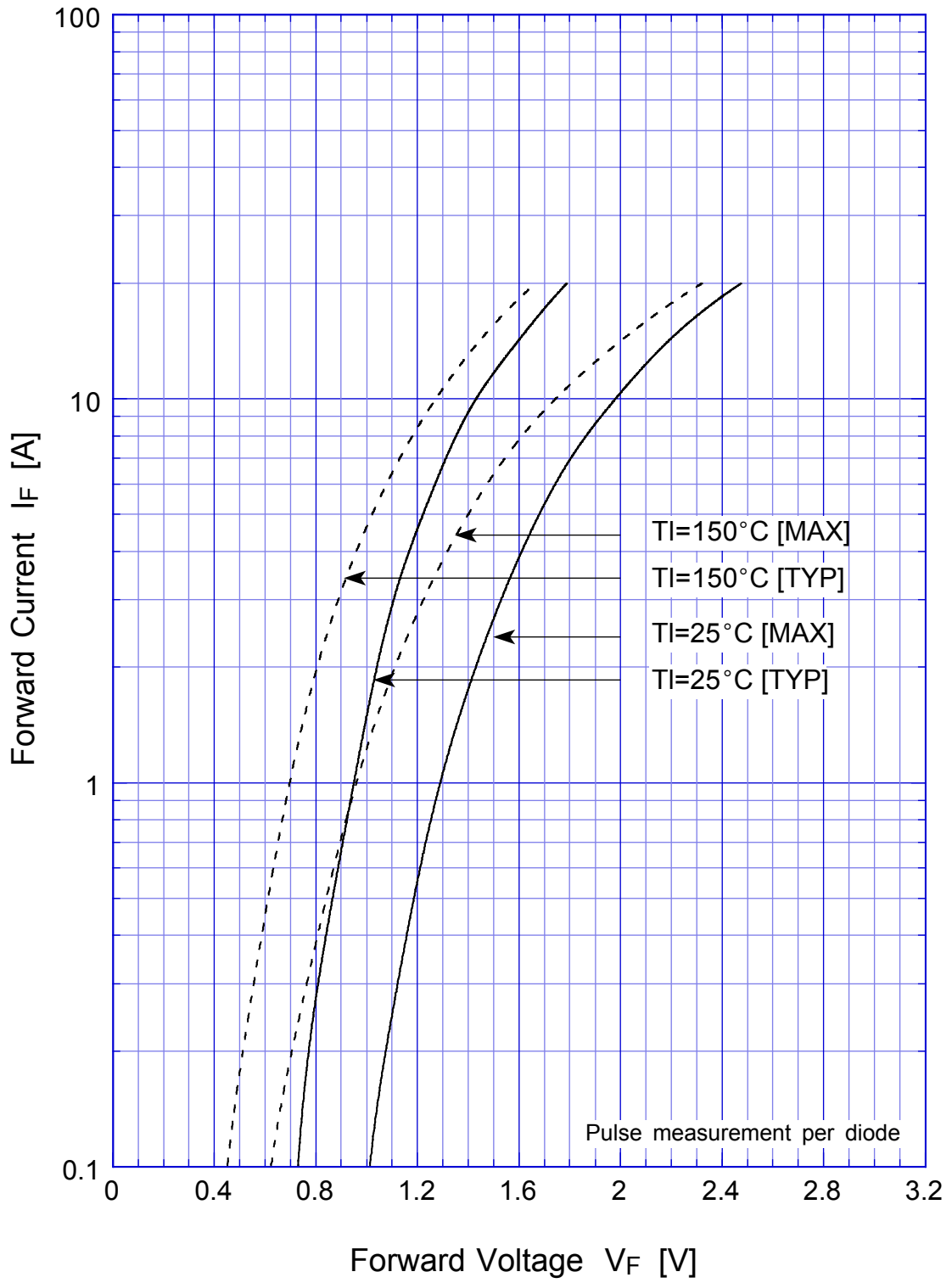

S2L40

Forward Power Dissipation

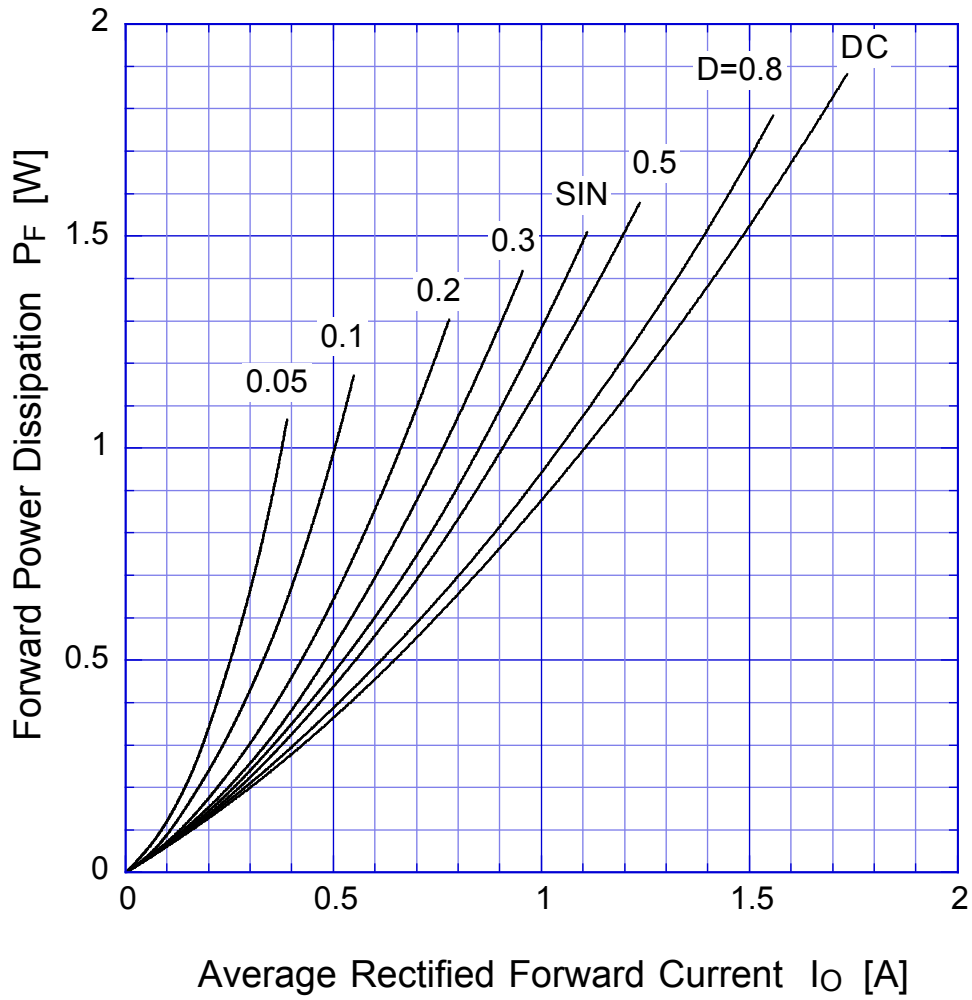

$T_j = T_{jmax}$

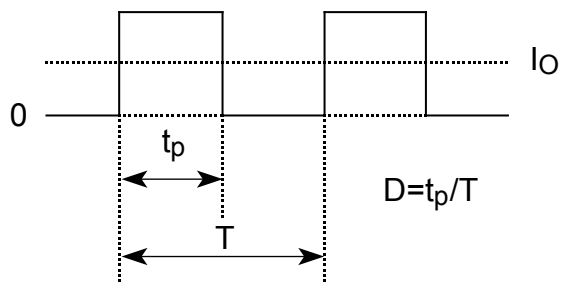

S2L40

Derating Curve

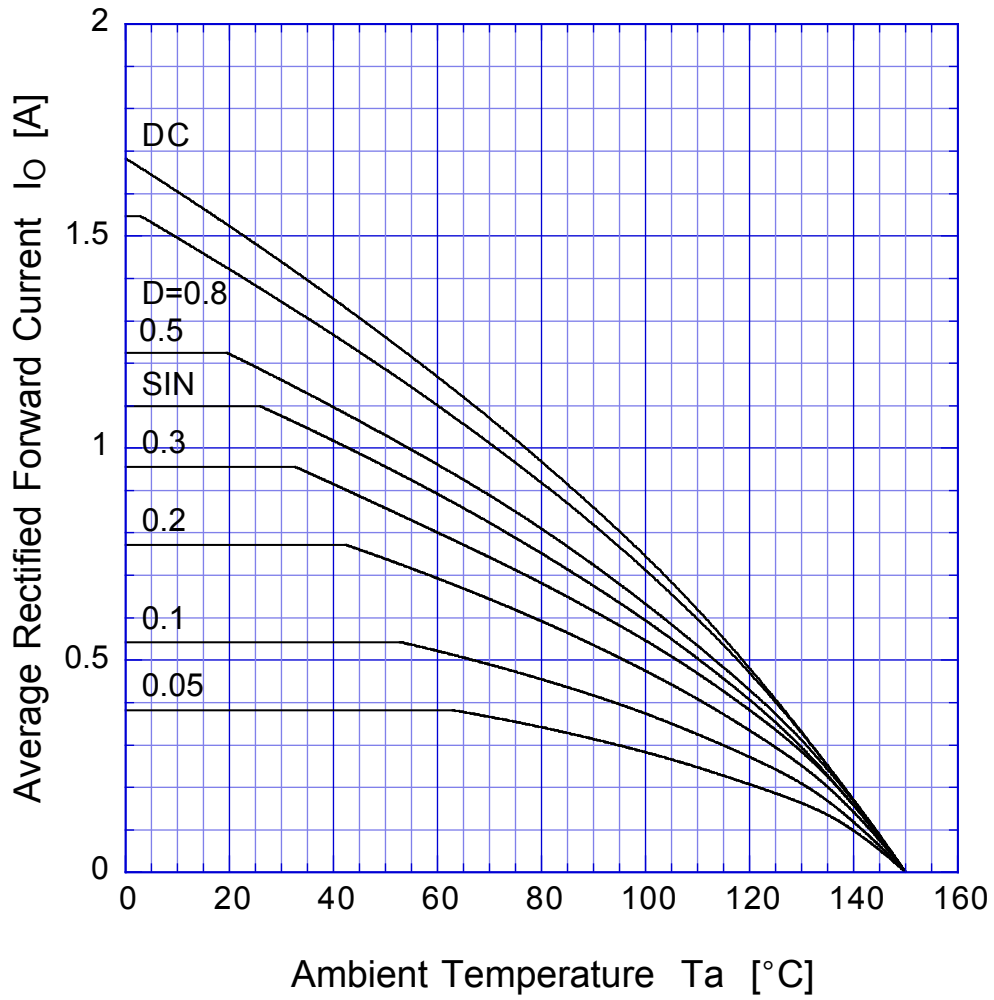

$$V_R = V_{RM}$$



S2L40

Peak Surge Forward Capability

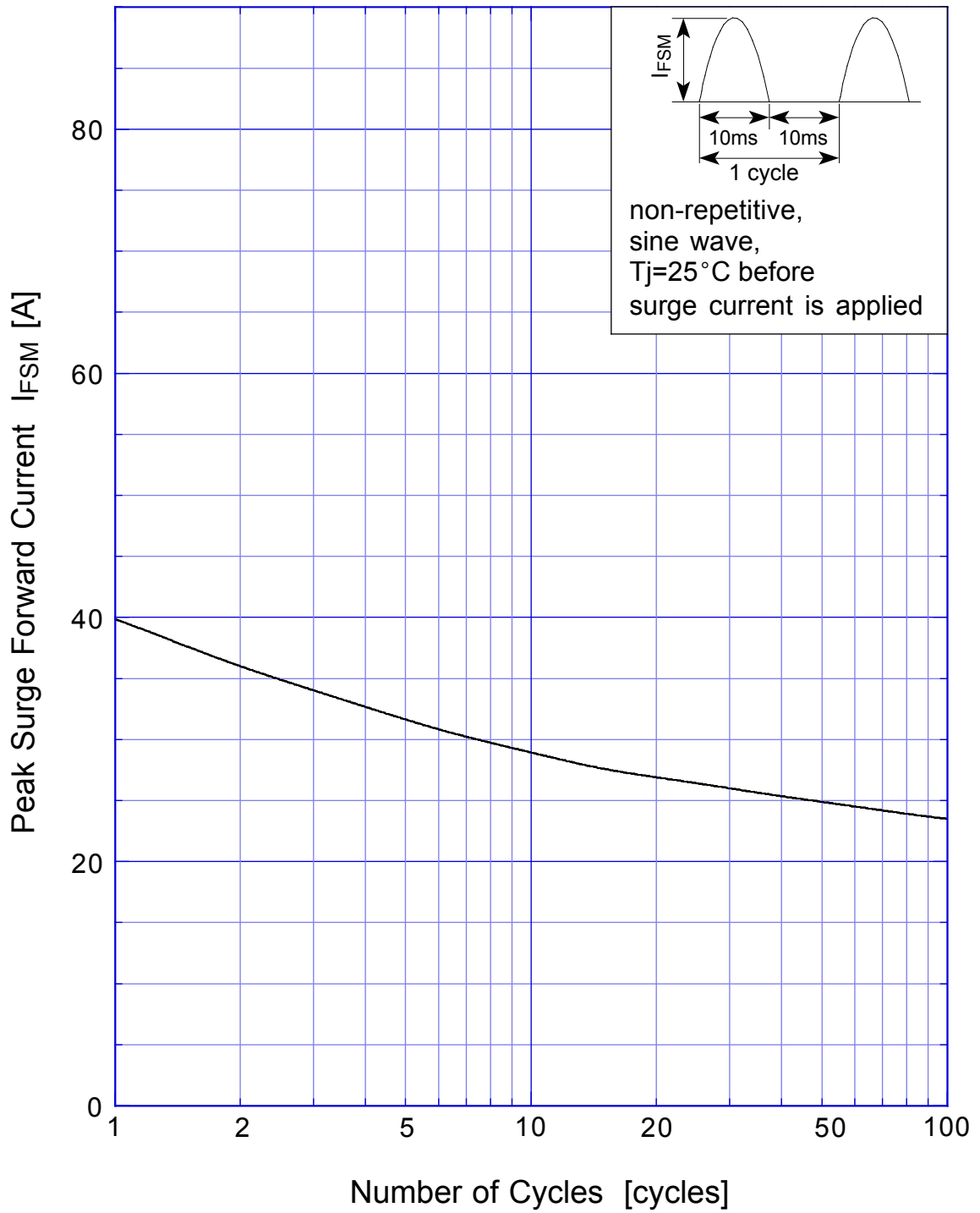

S2L40 Junction Capacitance

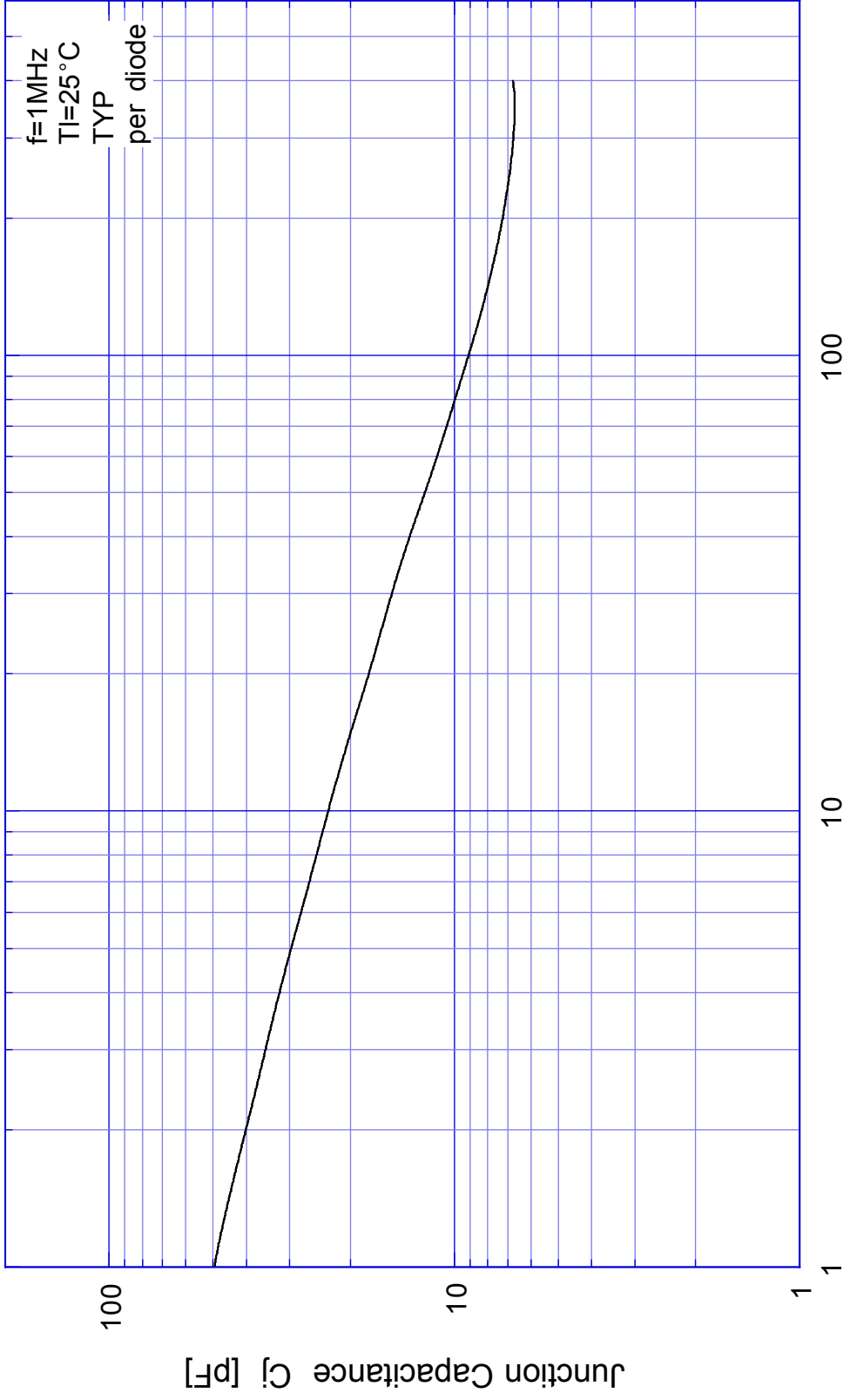

Reverse Voltage V_R [V]